

# Process Analytics Catalog



International  
2024/25

- pH/ORP
- DO & Ozone
- CO<sub>2</sub>
- TOC/Microbial Detection
- Conductivity/Resistivity
- Turbidity
- Housings & Cleaning Systems
- Sodium/Silica Analyzers
- Chloride/Sulfate Analyzer
- Gas Analyzers
- Single-Use Sensors



## Process Analytics Measurement Solutions for Industrial Applications

METTLER TOLEDO

# METTLER TOLEDO's Distribution Network

## Worldwide

**METTLER TOLEDO provides full sales and service coverage worldwide. Wherever our customers are, we are the competent partner. Many global manufacturers rely on our long-standing experience to ensure the highest levels of product and process quality control.**

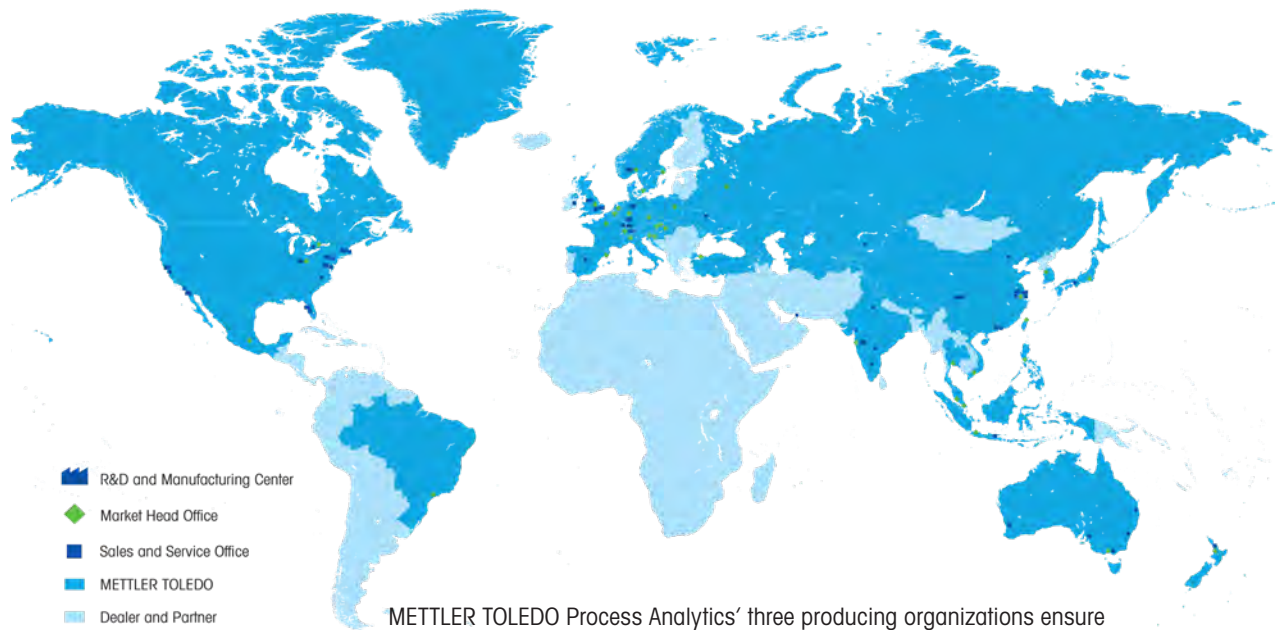

METTLER TOLEDO Process Analytics' three producing organizations ensure faster logistics and response time to market demands in all global regions.

### Distribution network

Based at several global production sites, with more than twenty market organizations, and numerous sales representatives, METTLER TOLEDO maintains a distribution network all around the world. Satisfaction of our customers is based on three pillars:

- Consulting
- Products
- After-sales service

Our highly skilled experts are at your disposal to support you in finding the best solution for your measurement application, including planning, product selection, and installation.

CONSULTING

PRODUCTS

A complete range of products and systems to meet your specific measurement requirements.

### AFTER-SALES SERVICE

With our customized, lifelong service management, we are able to assist in managing measurement loops throughout their entire life cycle.

**INGOLD**

Leading Process Analytics

---

**THORNTON**

Leading Pure Water Analytics

---

**PENDOTECH**

Leading Process Analytics

---

# **Process Analytics Measurement Solutions**

---

## for Industrial Applications

# Table of Contents

## Process Analytics Catalog

### ■ Introduction

About METTLER TOLEDO	4
Tools and Services	6
System Integration	8
Intelligent Sensor Management (ISM)	10

### ■ Ingold

#### ■ pH

pH and ORP Systems	14
METTLER TOLEDO pH Electrodes	16
InPro X1 HLS	18
InPro 2000 (i)	20
InPro 3100 (i)	22
InPro 3250 (i)	24
InSUS 310i	26
InPro 4010	28
InPro 4260 (i)/InPro 4281 i	30
InPro 4550/InPro 4501	32
InPro 4800 (i)/InPro 4881 i	34
InPro 4850 i	36
Puncture pH Electrodes	38
pH Buffers, Electrolytes, Cleaning and Storage Solutions	39
Pro2Go Portable pH/ORP Meter	40

#### ■ Dissolved Oxygen

Dissolved Oxygen Measurement Systems	42
InPro 6860 i Optical Oxygen Sensor	44
InSUS 607/InSUS H60i	46
Powering Accessories for InPro 6860 i	48
InPro 6960 i/InPro 6970 i	
Optical Oxygen Sensor	50
InPro 6800/InPro 6850 i (12 & 25 mm)	52
InPro 6900 (i)/InPro 6950 i	54
InTap: Portable Optical DO Analyzer	56
InPro 6050	58
Oxygen Accessories and Spare Parts	59

### ■ Dissolved Carbon Dioxide

In Situ Monitoring of Dissolved CO <sub>2</sub> in Bioreactors	60
In-line CO <sub>2</sub> Measurement in Beverages	61
InPro 5000 i	62
InPro 5500 i	64

### ■ Turbidity/Optical Density

Versatile Turbidity Measurement	66
InPro 8050/InPro 8100 (Single Fiber)	68
InPro 8200 (Dual Fiber)	70
InPro 8610i e/InPro 8630i e	72
InPro 8300 RAMS Series	74

### ■ Conductivity

Conductivity/Resistivity Systems	76
InPro 7000-VP	78
InPro 7100-VP	80
InPro 7100 (i)	82
InPro 7250	84

### ■ Transmitters

Transmitters for All Parameters	86
M200	88
M300 Process	90
M400 4-wire	92
M400 Type 1 Cond Ind	96
M800	98
M100 DIN Rail	102
M100 Sensor Mount Transmitter	103
M80 Sensor Mount Transmitter	104
M400 2(X)H Type 2 and Type 3, 2-Wire	106
M400 2-Wire	
2XH Type 1, Cond Ind, PA and FF	110

### ■ ISM Productivity Tools

ISMCore Introduction	112
ISMCore Software	114
Verification Kits	116

### ■ Housings

Process Connection Hardware	118
Sockets, Flanges, and Plugs	120
InFit 761 e	122
InFit 762 e/763 e	124
InFit 764 e	125
InDip 550	126
InDip 508/510	127
InFlow Series	128
Product Configurators and Sensor Fit Guides for InFit, InFlow and InDip Housings	129
InTrac 776 e	132
InTrac 777 e/779 e	133
InTrac 797 e/799 e	134
InTrac 781/784	135
InTrac 785/787	136
Product Configurators and Sensor Fit Guides for InTrac Housings	137

### ■ Automation

EasyClean	140
EasyClean Configuration	141
EasyClean 500	142
EasyClean 200 e	143
EasyClean 150/100	144
EasyClean Ordering Information	145

### ■ Cables

Cables and Connections	146
Cable Terminations	147
Cable Availability Cross Reference Table	148

## Gas Analytics

### Rethinking Gas Analytics

Introduction	152
Gas Oxygen Sensors and Analyzers	154
Measurement Theory	156
GPro 500 Sensor	158
GPro 500 Sensor Variant Configurator	160
InPro 6000G Sensor Series	162

## Thornton

### Conductivity/Resistivity

Conductivity/Resistivity Systems	166
UniCond Conductivity/Resistivity Sensors with ISM	168
UPW UniCond Sensor	170
Analog Conductivity Sensors	172

### pH Electrodes

pH and ORP Systems	176
pH/ORP Sensors with ISM	178
pHure Sensor with ISM	180
pHure Sensor LE with ISM	182
pH/ORP Housings, Buffer Solutions	184

### Dissolved Oxygen and Ozone Sensors

Oxygen Measurement Systems	186
Ozone Measurement Systems	187
Pure Water Optical DO Sensor	188
High Performance DO Sensors with ISM	190
pureO <sub>3</sub> Dissolved Ozone Sensor with ISM	192

## Flow Sensors

Vortex Flowmeters	194
Sanitary Flow Sensors	196

### Total Organic Carbon (TOC)

Total Organic Carbon (TOC)	198
4000TOC e	200
6000TOC i	202
6000TOC i low ppb	206
450TOC	208
TOC Pump Module	210

### Microbial Detection Analyzer

7000RMS	212
---------	-----

### Sodium Analyzer

2300Na Sodium Analyzer	214
2301Na Sodium Analyzer	216

### Silica Analyzer

2850Si Silica Analyzer	218
------------------------	-----

### Ion Analyzer

3000 CS Chloride & Sulfate Analyzer	220
-------------------------------------	-----

## Transmitters

Transmitters for All Parameters	222
M200	224
M300 Water	228
M800 Multi-Parameter, Multi-Channel Transmitter	232
Recommended Transmitter	
Service Agreements	234
21CFR RecordLOC	235

## Pendotech

### Introduction Single-Use

Pressure Sensor	238
Single-Use Pressure Sensor	240
PressureMAT Sensor Transmitter	242
Single-Use Conductivity Sensor	246
Single-Use-In-line pH Sensor	248
Single-Use UV Flow Cells & PM 2 Photometer	250
Single-Use Temperature Sensors	254

### Trademark Notice

256



#### Info

General information about the product



#### Quick Tip

Useful tips and tricks for the product



#### Did You Know

Additional and helpful information

# METTLER TOLEDO

## The Leader in Process Analytical Measurement

### METTLER TOLEDO Group

METTLER TOLEDO specializes in providing precision instruments with the most comprehensive range of services on a global level. With more than 18,000 employees, the company generates annual sales of over US\$ 3.9 billion. Mettler-Toledo International Inc. has been listed on the New York Stock Exchange since 1997 (MTD).

METTLER TOLEDO instruments are used for critical research and development applications and also for quality control purposes. The pharmaceutical, micro-electronics, chemical, food & beverage, and cosmetic industries are among the principal users. METTLER TOLEDO enjoys an excellent reputation as an innovator, and currently invests more than US\$ 170 million per

year in research and development, having increased overall R & D spending. METTLER TOLEDO makes every effort to meet the highest quality standards, resolutely applying Total Quality Management at both the product and process level, but specifically as part of our support for customers to comply with international guidelines.

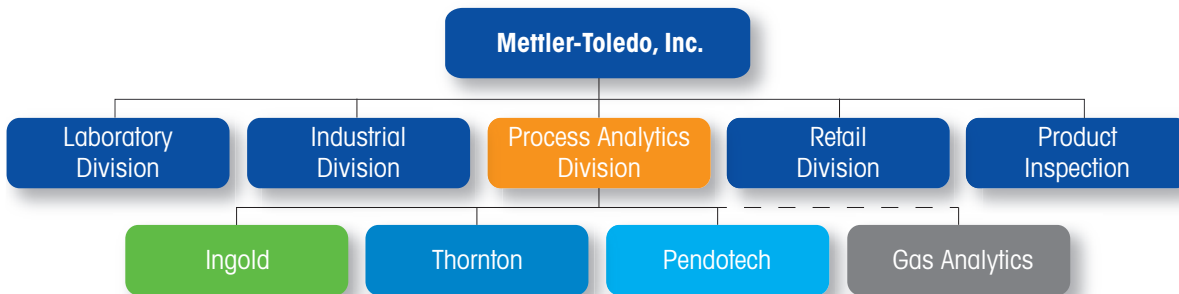

### METTLER TOLEDO Process Analytics

Within the METTLER TOLEDO Group, the Process Analytics division concentrates on analytical measurement solutions for industrial manufacturing processes. The division consists of three business units: Ingold, Thornton and Pendotech, each recognized as leaders in their respective markets and technologies. Ingold is a worldwide leader in pH, dissolved oxygen, CO<sub>2</sub>, conductivity and turbidity solutions for process

analytical measurement systems in chemical, food & beverage, biotechnology and pharmaceutical industries. Its core competence is high quality in-line measurement of these parameters in demanding chemical process and hygienic and sterile applications. They also provide an innovative series of TDL gas analyzers for in situ gas monitoring in industrial applications. Thornton is the leader in pure and ultrapure water monitoring instrumentation used in semiconductor,

microelectronics, power generation, pharmaceutical, and biotech applications. Its core competence is the in-line measurement of conductivity, resistivity, TOC, bioburden, dissolved oxygen and ozone in determining and controlling water purity. Pendotech is a leader in single-use technology for downstream bioprocessing, with a diverse offering of pressure sensors, control systems and software for measuring, monitoring and data collection in bioprocess applications.

## Ingold

Dedicated to providing innovative, high-quality solutions for demanding process analytics applications

Ingold was founded in 1948 by Dr. Werner Ingold. Today, Ingold provides the broadest range of in-line analytical measurement solutions for industrial processes in the biotechnology, pharmaceutical, chemical, and beverage industries.

Latest developments include optical DO sensors and a management platform for simplifying sensor maintenance and handling.



## Thornton

The market leader in critical ultrapure and pure water analytics

Thornton Inc., founded in 1963 by Dr. Richard Thornton, a Professor at Massachusetts Institute of Technology, has been part of the Process Analytics Division since 2001. Thornton instrumentation is trusted globally in the pharmaceutical, biotech, power generation, and microelectronics sectors.

With the introduction of its microbial contamination analyzer, Thornton is the world's only producer of conductivity, TOC, and bioburden measurement solutions for USP-regulated ultrapure waters.



## Gas Analytics

Innovative, alignment-free, and easy-to-use in situ tunable diode laser solutions

In Gas Analytics we provide a broad range of in situ and at-line analytical measurement solutions for industrial processes in the chemical, petrochemical, refining, and pharmaceutical industries.

Our innovative sensors and analyzers cover oxygen, carbon monoxide, carbon dioxide, hydrogen sulfide, methane, and other gases.

The employed tunable diode laser and optical technology combine high measurement accuracy with ease of installation and use.



## Pendotech

User-friendly, adaptive process equipment for biopharma downstream manufacturing and research

Founded in 2005, Pendotech focuses on sensors, monitors, and control systems for use in developing and optimizing production processes for biopharmaceuticals such as antibodies, recombinant proteins, vaccines, and cell therapy products.

Our solutions deliver the high-level, cost-effective monitoring and control that biopharmaceutical manufacturers depend on.



# www.mt.com/pro

## Fast and Competent On-line Support

Visit our website at any time for fast and competent information. The very latest, updated product and support documentation is available in many different languages.

### ■ Unlimited access

#### What you need:

- Fast access to product documentation
- Suitable process analytical solution
- Access to certificates

#### What we offer:

- Information on products and measurement solutions
- Success stories about our solutions in your industry
- Country specific information and service offerings
- Personalized access
- Multilingual information
- Extensive download offerings

### ■ Comprehensive Expertise

#### www.mt.com/library

When you need analytics expertise to help you with your analytical project, METTLER TOLEDO's Expertise Library provides the content you need. In the Expertise Library includes:

- Customer Case Studies
- Expert Webinars & Interviews
- Technical White Papers
- Practical Application Notes
- Competence Guides
- Product Brochures & Datasheets

#### Find information on:

- Pharmaceutical processes
- Biotech and hygienic processes
- Chemical and petrochemical processes
- Water purification processes
- Wastewater applications

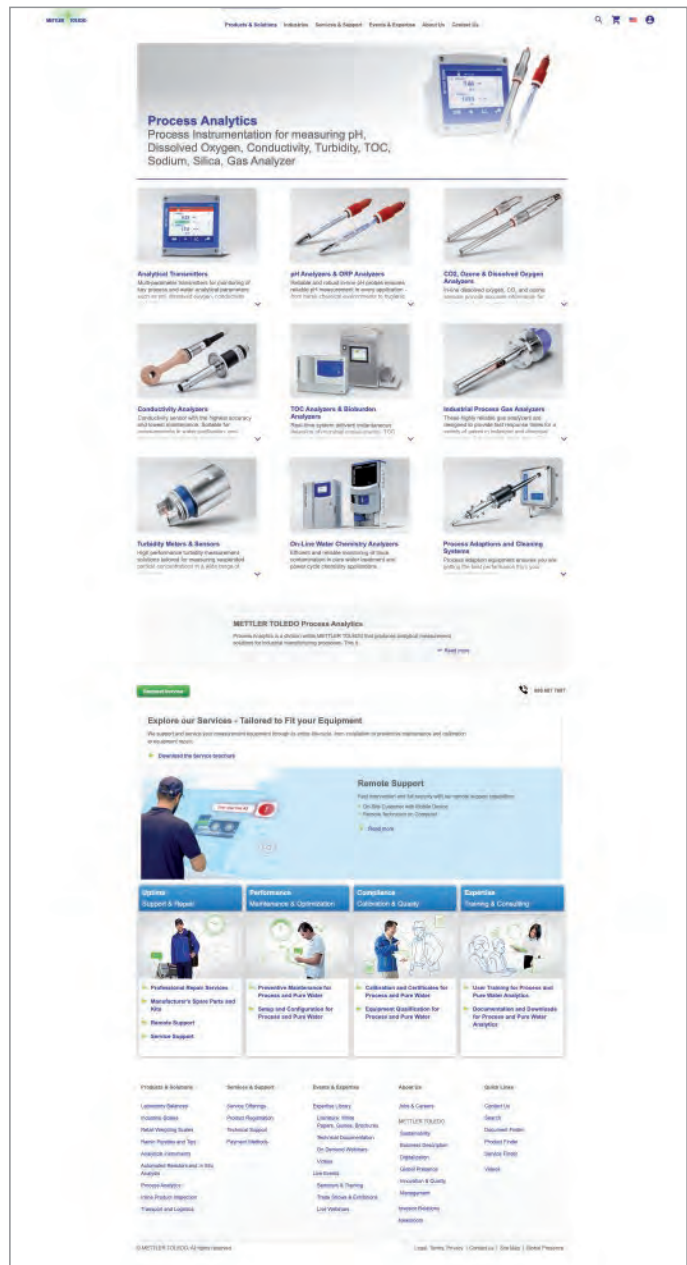



# Customer Service/Technical Service

## Seven Reasons to Choose METTLER TOLEDO

**Customer service at METTLER TOLEDO strives to provide you with added value including professional product services as well as leading edge technical support.**

### **Our focus is customer success**

The METTLER TOLEDO organization has the largest, best-trained global service network in the industry. Our worldwide presence and reputation for outstanding quality make us the logical choice not only to provide classical services but also for services that go far beyond those of other providers.

We understand that customers today are interested in value-added solutions that give them competitive advantages in the marketplace. And that is what we endeavor to deliver. Providing the highest levels of service and customer satisfaction is very important to METTLER TOLEDO Process Analytics and we understand that you expect not only the highest quality products, but also superior customer and technical support when you need it.

Service from METTLER TOLEDO goes far beyond the initial purchase. We pride ourselves in being available for you, whether it is to answer a technical question, provide details on system operation or to manage requests for service.

When you purchase products from METTLER TOLEDO you have the satisfaction of relying on proven products in your process and having a world class service organization standing behind them.

METTLER TOLEDO offers comprehensive, tailored service plans to meet your needs. Please contact your local METTLER TOLEDO representative for your individual solution.

▶ [www.mt.com/contacts](http://www.mt.com/contacts)

### **Our customers benefit from**

- **Quicker repairs and calibration**
- **Reliable, professional, efficient service**
- **Fast response time**
- **Higher system uptime**
- **Innovative and leading edge support services that meet future needs**
- **Regulatory compliance**
- **Improved productivity and enhanced competitiveness**



## Asset Management and Plant Maintenance With Fieldbus and High Speed Industry Bus

**Open bus integration of your process analytical measurement technology into your control system via digital fieldbus and high speed industry bus technology.**

Open fieldbus protocol and industry bus such as HART, Foundation Fieldbus, PROFIBUS, Profinet and Ethernet/IP are currently regarded as standard in the process industry. Only bus technology enables full use of the functional advantages of digital communication to be able to achieve improved resolution of measured values, intelligent instrument diagnostics and new control strategies.

### **METTLER TOLEDO integration with fieldbus and high speed industry bus**

These standardized communication protocols allow a central overview of the whole plant network. In addition, they offer the opportunity of comfortable instrument configuration and a higher level of process information to improve plant performance. Field process instrumentation becomes an integral part of the control and operation level. This technology provides an optimized and continuously available interface for your plant management and maintenance planning.

### **Integrated device descriptions**

Our intelligent analytical instruments include electronic device descriptions (DD) for various process instrument configuration software tools to support seamless integration into the control and engineering level.

### **Bus communication in connection with asset management and predictive maintenance and information**

By applying Ethernet/IP, PROFINET, HART, Foundation Fieldbus or PROFIBUS, seamless integration of advanced Intelligent Sensor Management (ISM) diagnostics information into your process control system is guaranteed.

The use of asset management and predictive maintenance are an important element in improving plant management. The bus technology of Ethernet/IP, PROFINET, HART, Foundation Fieldbus and PROFIBUS supports the online status integration information requirements in an unprecedented way.

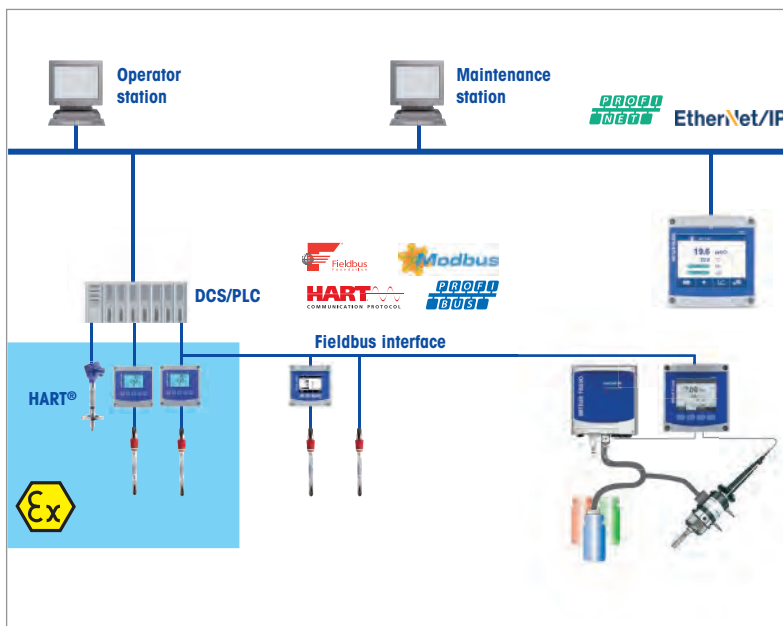



## ISM – Intelligent Sensor Management Beyond Process Confidence

**ISM™ is a digital technology for process analytics. ISM sensors output highly reliable measurements, which help in maintaining process consistency. Advanced diagnostics data from the sensors can be transferred to wherever required and enable true predictive maintenance.**

To ensure production consistency and maintain high product quality, you need accurate and reliable analytical sensors. However, analog sensors have several issues that can negatively impact your production efficiency, such as:

- Not knowing if a sensor is measuring accurately.
- Not knowing if a sensor is suddenly going to fail in the process.
- Sensor measurements that fluctuate due to electromagnetic interference

from surrounding equipment.

- Time-consuming calibration at hazardous measurement points.
- Planning and conducting maintenance with limited resources.

ISM solves all these problems.



### Measure

ISM sensors utilize METTLER TOLEDO's decades long expertise in process analytics sensor technology to ensure the highest measurement accuracy, regardless of how challenging the process conditions are. Once measured, the sensors' interference-prone analog signal is converted to a robust digital signal before being sent to the connected transmitter.

Built-in health monitoring in ISM sensors mean you always know if they are measuring reliably.

The combination of leading-edge sensor technology and health monitoring ensures you can always fully rely on the measurements from ISM sensors.



### Integrate

ISM can be easily incorporated into your facility without major infrastructure investment, time-consuming configuration, or verification efforts. Once integrated, you can receive information from ISM sensors wherever required. Allowing you to...

Check the health of ISM sensors on a handheld device or remotely.

Automatically issue a maintenance order.

And more.



### Manage

One of the main issues with analytical sensors has been keeping them properly maintained. And knowing when to conduct maintenance that has been more art than science.

With ISM, you can clearly see the health of your sensors all the time. Advanced predictive diagnostic tools show you how many days remain before calibration, part replacement, or sensor replacement will be needed.

And when maintenance is required, ISM Core PC software guides operators step-by-step through the process.

**Measure**  
Accurately and Reliably

**Integrate**  
Fast and Seamlessly

**Manage**  
Efficiently and Safely

**ISM**

**METTLER TOLEDO**

**ISM**

Discover more reasons to switch to ISM at: ► [www.mt.com/ism](http://www.mt.com/ism)



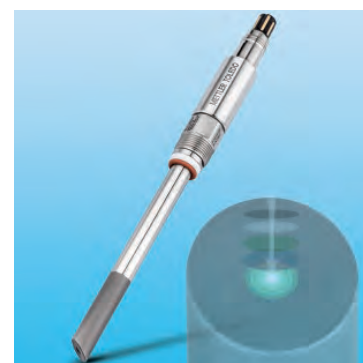
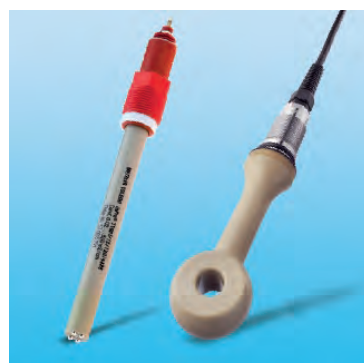

# Process Analytics Measurement Solutions for Industrial Applications

# pH and ORP Systems

## For Harsh Industrial to Pure Water Applications

**With many decades of experience in designing pH/ORP electrodes, METTLER TOLEDO offers a state-of-the-art solution for practically any type of process analytical application.**

**Functional definition**

pH can be described as a measurement of the relative acidity of a solution. Oxidation reduction potential (ORP) as measured with an ORP electrode, provides an indication of the oxidative state of the solution. It is important to measure, and often to control the pH and/or ORP of a solution for several reasons:

- To produce products with consistent well defined properties
- To efficiently produce products at optimal cost

- To avoid health risks
- To protect the environment
- To prevent physical/chemical damage to materials
- To meet regulatory requirements
- To expand scientific knowledge

The accurate measurement of pH/ORP is critical in most industries. Each application has unique physical requirements of chemical, temperature, and pressure resistance and possibly hygienic design. Another factor is what is to be done with the measurement:

monitoring only, data logging or process control.

**pH electrode selection**

It is important to understand the details of the application before selecting a pH electrode. The table on page 15 gives an initial glance at the various electrodes available and typical applications. Selection of a pH electrode requires a thorough knowledge of the process. Once the requirements are known, comparison of the electrode specifications detailed in this catalog will identify the appropriate sensor.





**Table:**  
**Ingold pH sensor selection guide**  
**by industries and applications**

Refer to page:	p. 18	p. 20	p. 22	p. 24	p. 34	p. 30	p. 32	p. 32	p. 38	p. 36	p. 26
	X-Chip pH sensing technology InPro X1 HiS	Refillable electrolyte InPro 2000(i)	Gel or liquid electrolyte InPro 3100(i)	InPro 3250(i) (liquid)	InPro 4800(i) / InPro 4881 i	Solid polymer electrolyte InPro 4260(i) / InPro 4280i	InPro 4501	InPro 4550	Puncture pH electrode pNa reference InPro 4360i	Single-use sensor InSUS 310i	
<b>Industrial Processes</b>											
Chemical production monitoring		•		•	•	•	•	•			
Chlorine production		•			•					•	
Dyestuff production					•	•	•	•			
Mining					•	•	•	•			
Petroleum & refining		•		•	•	•	•	•			
Pulp & paper		•			•	•	•	•			
<b>Pharmaceutical Industry</b>											
BioPharma											
Upstream		•	•	•							•
Downstream		•	•	•							
ChemPharma		•	•	•		•					
<b>Food &amp; Beverage Processes</b>											
Brewery & beverage production	•										
Dairy	•										
Milk processing	•										
Yogurt production	•										
Cheese making	•								•		
Meat	•								•		
Wine	•										
Sugar & starch	•										
Yeast	•										
Cleaning solutions (CIP)	•										
<b>Water Treatment</b>											
Air scrubbers		•			•	•	•				
Cooling water		•		•		•	•				
Neutralization				•	•	•	•				
Potable water		•	•	•							
<b>Wastewater Treatment</b>											
Flue gas neutralization		•		•	•	•	•				
Galvanic wastewater				•	•	•	•				
Industrial wastewater					•	•	•				
Precipitation of heavy metals		•		•		•	•				
Sludge dewatering						•	•				

This table serves as an initial selection guide to suitable Ingold pH sensors for given applications. Since process con-

ditions vary considerably at different stages of production, it is necessary to refer to the detailed technical speci-

fications of the electrode to ensure compatibility.

## METTLER TOLEDO pH Electrodes

### The Problem Solvers...Through 70 Years of Innovation!

The design of the pH electrode reflects the potential problems each application may present. On these two pages, application questions are raised, and the METTLER TOLEDO Ingold solutions are described.

#### Is frequent steam sterilization or autoclaving a requirement?

When frequent steam sterilization, autoclaving, or other dramatic process temperature cycling is encountered, the "Argenthal" reference system maintains a constant concentration of silver chloride at the reference electrode silver wire, providing stable and repeatable reference voltages.

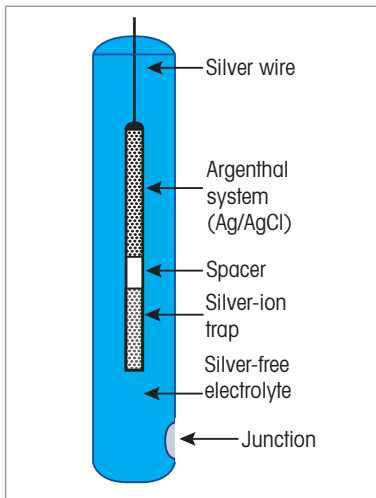

Reference electrode  
Argenthal system/silver-ion trap

#### Does the sample contain components which could react with the reference electrolyte?

One source of problems is the reaction of silver-ions in the reference electrolyte with sulfide or other complexing compounds in the sample medium. The unique Ingold internal "silver-ion trap" prevents silver ions from entering the bulk electrolyte. Alternatively, use of "double junction" electrodes and selection of specialized electrolytes also serve to ensure chemical compatibility.

#### What are the temperature and pressure requirements of the installation?

Temperature and pressure requirements of a process must be met to ensure safe operation of the system as well as accurate performance of the electrode. Electrodes are available with specifications as high as 13 bar at 130°C (188 psig at 266°F) to handle aggressive process situations.

#### What glass formulation is appropriate?

Numerous formulations of pH-sensitive glass have been developed to overcome application problems. "High Alkali" glass greatly reduces "sodium ion error" expanding the usable pH range from pH 12 of general purpose glass to pH 14. "Low Temperature Glass" allows continuous use at low temperatures which

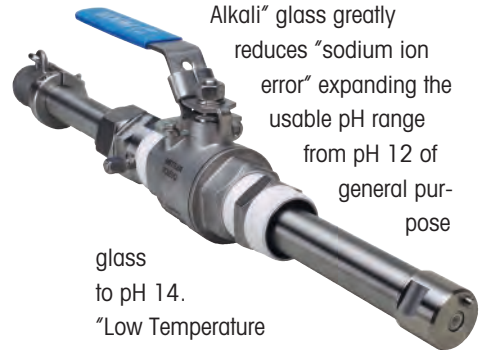

present high impedance problems with standard glass. "HF-resistant glass" permits use of glass electrodes at HF levels which rapidly dissolve normal glass electrodes.

#### What are the physical requirements?

Among physical considerations are length, connector type, and installation. Electrodes are commonly available in lengths from 120 mm to 425 mm or longer to ensure sufficient immersion depth into the process. Improvements in electrode connector technology over

the years have resulted in numerous connector configurations. Polymer body "industrial pH sensors" serve as their own housing, fitting directly into threaded connections.

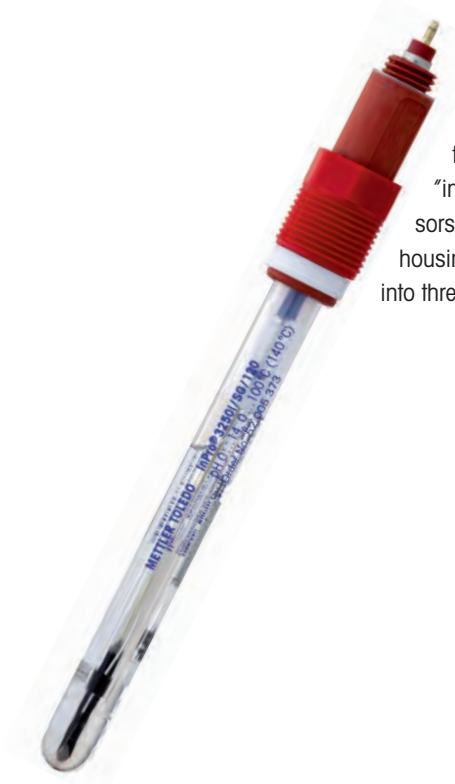

#### Which type of reference electrolyte should be used?

Liquid reference electrolytes provide high flow through the junction keeping it clean and providing the highest accuracy and precision, and are refillable for longer life. Use of pressurized gel electrodes prevents process solutions from entering the reference electrolyte, are more compact and reduce maintenance. Solid polymer electrolytes are in direct contact with the sample medium without requiring a ceramic junction, eliminating fouling problems.

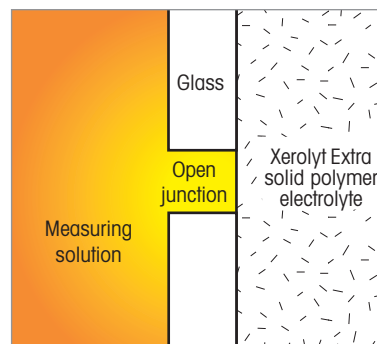

# InPro X1 HLS

## Unbreakable Sensors for Hygienic Applications



InPro X1 HLS

ISM

With its unbreakable\* X-Chip™ technology, the InPro X1™ HLS offers extremely safe and highly reliable pH measurement for food or beverage production processes. The sensor's low drift and long lifetime reduce maintenance, calibration and replacements costs. Its rapid response to pH changes improves process control, leading to lower consumption of additives and shorter batch times.

Intelligent Sensor Management (ISM) digital technology provides predictive diagnostics, such as the Dynamic Lifetime Indicator (DLI), interference-free signal transmission, fast Plug and Measure installation and easy calibration with ISM Core software.

\* The InPro X1 has passed the US military's MIL-STD-810H drop test.

### Specifications

ISM (Digital) or Analog	ISM (Digital)
pH Sensing Technology	Composite X-Chip
pH Range	0–14
Reference System	Pre-pressurized liquid electrolyte, ceramic diaphragm, Argenthal cartridge with silver-ion trap
Operating Temperature (for Cleaning)	0–80 °C (100 °C)/32–176 °F (212 °F)
Operating Pressure	0–4 barg/0–58 psig
Process Connection	Pg 13.5 thread
Temperature Sensor	Digital
Shaft Material	Food-grade PEEK
Solution Ground	12 mm
Sensor Length	120 mm, 225 mm
Hazardous Area Approvals	Yes (see Certificates and Approvals below)
Hygienic/Biocompatibility Approvals	Yes (see Certificates and Approvals below)
Sterilizable/Autoclavable	No
Primary Media/Application	Food/Beverage Production
Certificates & Approvals	CE, EHEDG, 3A, EC1935/2004, ATEX/IECEx: Ex ia IIC T6/T5/T4/T3 Ga/Gb, FM: IS Cl. I, II, III, Div 1, GR ABCDEFG/T6, PED, METTLER TOLEDO Quality Certificate

### Intelligent Sensor Management (ISM)

pH electrodes with integrated ISM functionality allow Plug and Measure and advanced diagnostics. ISM simplifies the installation, handling and maintenance of measurement equipment. For more information see ISM introduction pages 10–11.

## Ordering Information

pH Sensor	Shaft Length	Order Number
InPro X1 HLS-N200-K120	120 mm	30 389 700
InPro X1 HLS-N200-K225	225 mm	30 389 701



### Resists Clean-in-Place Processes

The InPro X1 HLS is the first food-safe, in-line pH sensor that withstands cleaning without sacrificing accuracy or sensor lifetime.



### Eliminates Risk of Glass Contamination

The unbreakable X-Chip pH-sensing technology enables in-line pH measurement without the risk of contamination by glass fragments.

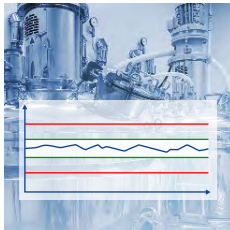

### Improve Product Yield and Quality

Real process control through precise in-line pH measurement leads to improved product quality, yield and shorter batch times.



### Meets All Major Food Regulations

The InPro X1 HLS has a hygienic design, with all materials selected for food or beverage contact applications. Available certificates include 3A, EHEDG, EC1935/2004, ATEX and FM.

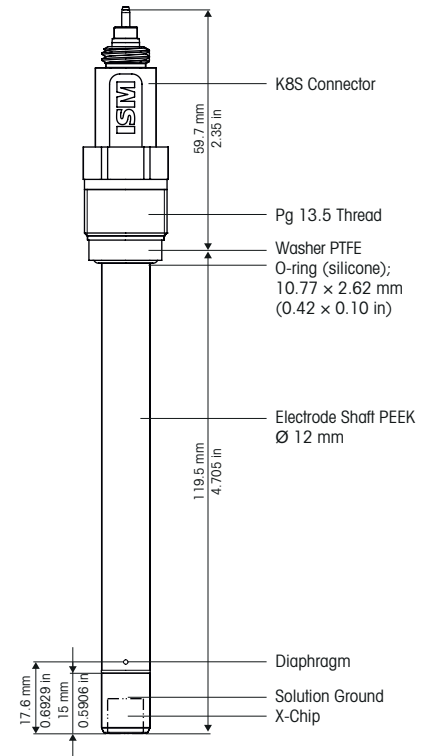

Dimensions of the InPro X1 HLS



Suitable Housings	p.
InFit 761 e .....	122
InFit 762 e .....	124
InDip .....	126
InTrac 777 e .....	133
InTrac 797 e .....	134
InTrac 781 .....	135
InTrac 785/787 .....	136

# InPro 2000 (i) For the Most Extreme Requirements



InPro 2000

InPro 2000i/SG

The InPro 2000 (i) is a combination pH electrode with an integral temperature sensor designed for highly demanding applications. Three liquid electrolytes are available adding versatility; 3M KCl is a classic electrolyte offering high flow for improved junction cleaning, Viscolyt has limited flow for reduced maintenance needs, and Friscolyt is ideal for process media with high protein or organic solvent content, and in low temperatures. Applications range from biotechnical processes requiring in-situ sterilization to dirty industrial processing chemicals.

### Specifications

pH range	0 – 14 pH
Temperature	0 to 140 °C (32 to 284 °F)
Operating pressure	0 to 6 barg, 0 to 87 psig (in pressurized housing)
Cable connection	ISM: K8S; Analog: VP
Process connection	METTLER TOLEDO Housing Adapter
Reference system	Argenthal with silver-ion trap
Type of junction	Ceramic junction
Reference electrolyte	Selectable; 3M KCl, Viscolyt, or Friscolyt
Lengths	120 mm, 150 mm, 250 mm, 450 mm
Lower shaft diameter	12 mm
Temperature sensor	ISM: Digital; Analog: Pt 100 or Pt 1000
Sterilizable	Yes
Autoclavable	Yes
pH membrane	High alkali glass (HA)

**Certificates and Approvals** METTLER TOLEDO Quality Certificate, Pressure Equipment Directive guidelines (PED) 97/23/EC, ATEX: Ex ia IIC T6/T5/T4/T3 Ga/Gb, FM: IS Cl. I, II, III, Div 1, GR ABCDEFG/T6

### Intelligent Sensor Management (ISM)

pH electrodes with integrated ISM functionality allow Plug and Measure and advanced diagnostics. ISM simplifies the installation, handling and maintenance of measurement equipment. For more information see ISM introduction pages 10–11.

### Features Overview

- User-selectable reference solution allows optimum compatibility with process media
- Flowing liquid electrolyte ensures fast response and accurate pH measurement
- Silver-ion trap prevents sulfide poisoning of junction
- Refillable electrolyte extends operational life
- Domed glass membrane impedes bubble formation for greater reliability
- Integral temperature sensor, more accurate temperature compensation
- ATEX and FM certification for hazardous areas

► [www.mt.com/InPro2000](http://www.mt.com/InPro2000)

## Ordering Information

ISM Electrodes	Length	Electrolyte	Temp. Signal	Order Number
InPro 2000i/SG	120mm	3M KCl	Digital	52 003 521
InPro 2000i/SG	150mm	3M KCl	Digital	30 068 948
InPro 2000i/SG	250mm	3M KCl	Digital	30 068 949
InPro 2000i/SG	450mm	3M KCl	Digital	30 069 160
InPro 2000i/SG	120mm	Viscolyt	Digital	52 003 522
InPro 2000i/SG	150mm	Viscolyt	Digital	52 003 523
InPro 2000i/SG	250mm	Viscolyt	Digital	52 003 524
InPro 2000i/SG	450mm	Viscolyt	Digital	52 003 525
InPro 2000i/SG	120mm	Friscolyt	Digital	52 003 526
InPro 2000i/SG	150mm	Friscolyt	Digital	52 003 527
InPro 2000i/SG	250mm	Friscolyt	Digital	52 003 528
InPro 2000i/SG	450mm	Friscolyt	Digital	52 003 529
<b>Analog Electrodes</b>				
InPro 2000	120mm	Viscolyt	Pt 100	52 001 426
InPro 2000	120mm	Viscolyt	Pt 1000	52 001 427
InPro 2000	250mm	Viscolyt	Pt 100	52 001 428
InPro 2000	250mm	Viscolyt	Pt 1000	52 001 429
InPro 2000	450mm	Viscolyt	Pt 100	52 001 738
InPro 2000	450mm	Viscolyt	Pt 1000	52 001 792
InPro 2000	120mm	3M KCl	Pt 100	52 001 430
InPro 2000	120mm	3M KCl	Pt 1000	52 001 431
InPro 2000	250mm	3M KCl	Pt 100	52 001 432
InPro 2000	250mm	3M KCl	Pt 1000	52 001 433
InPro 2000	450mm	3M KCl	Pt 100	52 001 794
InPro 2000	450mm	3M KCl	Pt 1000	52 001 777
InPro 2000	120mm	Friscolyt	Pt 100	52 001 434
InPro 2000	120mm	Friscolyt	Pt 1000	52 001 435
InPro 2000	250mm	Friscolyt	Pt 100	52 001 436
InPro 2000	250mm	Friscolyt	Pt 1000	52 001 437
InPro 2000	450mm	Friscolyt	Pt 100	52 001 655
InPro 2000	450mm	Friscolyt	Pt 1000	52 001 666

### InPro 2000 (i) Electrolytes

To cope optimally with the conditions prevailing in different types of chemical processes, a wide variety of electrolytes is available:

#### 9816 Viscolyt

Mostly frequently used CP electrolyte with limited outflow and therefore long refill intervals.

#### 9823 KCl

Classic electrolyte with high electrolyte outflow for improved diaphragm cleaning.

#### 9848 Friscolyt

Used for media with proteins/organic solvent content.

### Did You Know

The InPro 2000 (i) is the next generation of the 465 style electrode featuring temperature compensation. For further information please contact your local sales organization.

Suitable Housings	p.
InFit 763 e.....	124
InFit 764 e.....	125
InTrac 776 e.....	132
InTrac 784 .....	135

## InPro 3100 (i) Versatile and Robust



InPro 3100

InPro 3100i



Also available for upside-down installation as InPro 3100 (i) UD.

The InPro 3100 (i) is a combined pH electrode with temperature sensor designed specially for in-line pH measurements in bio-processes where CIP and SIP are used. This rugged gel-filled electrode provides fast and precise measurements, even after repeated autoclaving or sterilization cycles at 140 °C (284 °F). The electrode utilizes METTLER TOLEDO's silver-ion trap, keeping the reference junction clear even in the presence of sulfide-bearing solutions. With the InPro 3100 (i) UD, upside-down mounting is possible.

### Specifications

pH range	0–14 pH	
Temperature	InPro 3100 (i):	0 to 80 °C (32 to 176 °F) for operation 0 to 140 °C (32 to 284 °F) for sterilization
	InPro 3100 (i) UD:	0 to 80 °C (32 to 176 °F) for operation 0 to 130 °C (32 to 266 °F) for sterilization
Operating pressure	0 to 6 barg @ 140 °C (0 to 87 psig @ 284 °F)	
Cable connection	ISM: K8S; Analog: VP	
Process connection	Pg 13.5 thread	
Reference system	Argentinal with silver-ion trap	
Type of junction	Ceramic junction	
Reference electrolyte	Gel	
Lengths	120 mm, 150 mm, 225 mm, 325 mm, 425 mm	
Shaft diameter	12 mm	
Temperature sensor	ISM: Digital;	
	Analog: Pt 100 or Pt 1000	
Sterilizable	Yes	
Autoclavable	Yes	
pH membrane	High alkali glass (HA)	

**Certificates and Approvals** METTLER TOLEDO Quality Certificate, Pressure Equipment Directive guidelines (PED) 97/23/EC, ATEX: Ex ia IIC T6/T5/T4/T3 Ga/Gb, FM: IS Cl. I, II, III, Div 1, GR ABCDEFG/T6

### Intelligent Sensor Management (ISM)

pH electrodes with integrated ISM functionality allow Plug and Measure and advanced diagnostics. ISM simplifies the installation, handling and maintenance of measurement equipment. For more information see ISM introduction pages 10–11.

### Features Overview

- Fully autoclavable or sterilizable in-situ
- Gel electrolyte reduces maintenance
- Resistant to poisoning substances
- EHEDEG certified
- Pressure resistant up to 6 barg (87 psig)
- Integral temperature sensor permits automatic temperature compensation

► [www.mt.com/InPro3100](http://www.mt.com/InPro3100)



## Ordering Information

ISM Electrodes	Length	Temp. Signal	Order Number
InPro 3100i/SG	120 mm	Digital	52 003 515
InPro 3100i/SG	150 mm	Digital	52 003 516
InPro 3100i/SG	225 mm	Digital	52 003 517
InPro 3100i/SG	325 mm	Digital	30 090 877
InPro 3100i/SG	425 mm	Digital	30 091 063
InPro 3100i/UD	120 mm	Digital	52 005 433
InPro 3100i/UD	225 mm	Digital	52 003 583
InPro 3100i/UD	425 mm	Digital	30 803 903
Analog Electrodes			
InPro 3100	120 mm	Pt 100	52 000 656
InPro 3100	120 mm	Pt 1000	52 000 658
InPro 3100 UD	120 mm	Pt 100	52 002 531
InPro 3100 UD	120 mm	Pt 1000	52 002 752
InPro 3100	150 mm	Pt 100	52 000 659
InPro 3100	150 mm	Pt 1000	52 000 660
InPro 3100	225 mm	Pt 100	52 000 661
InPro 3100	225 mm	Pt 1000	52 000 662
InPro 3100 UD	225 mm	Pt 100	52 005 354
InPro 3100	325 mm	Pt 100	52 000 663
InPro 3100	325 mm	Pt 1000	52 000 664
InPro 3100	425 mm	Pt 100	52 000 665
InPro 3100	425 mm	Pt 1000	52 000 666



### Did You Know

All pH electrodes, even those with gel or solid polymer reference systems, contain a liquid electrolyte in the pH half cell which must be in contact with the internal silver wire in order for the sensor to measure accurately.

Sensors therefore must be installed at least 15° from horizontal to prevent air bubble interference. Exception: the InPro 3100 (i) UD “upside-down” electrode.

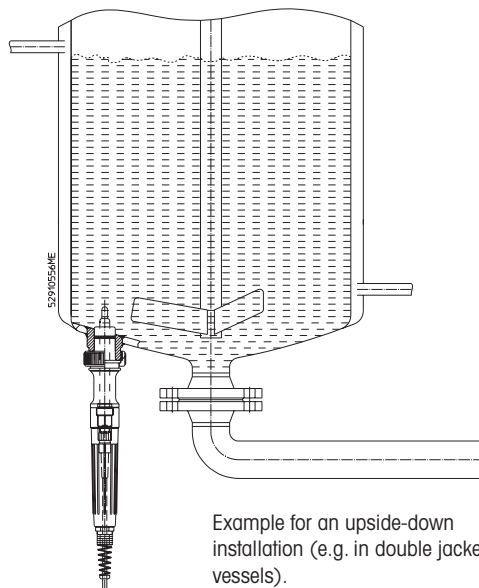

Example for an upside-down installation (e.g. in double jacket vessels).

### Suitable Housings

	p.
InFit 761 e .....	122
InFit 762 e .....	124
InDip .....	126
InTrac 777 e .....	133
InTrac 797 e .....	134
InTrac 781 .....	135
InTrac 785/787 .....	136

# InPro 3250 (i) Highest Performance, Highest Accuracy



InPro 3253

InPro 3250i

### Features Overview

- Fully autoclavable or sterilizable in-situ (InPro 3250 (i), InPro 3253 (i))
- Pressurized electrolyte reduces maintenance
- MaxCert, including biocompatibility according to USP 26, Chapter 87

The InPro 3250 (i) family is a pre-pressurized, liquid-filled, low-maintenance pH sensor with temperature sensor for in-line measurements in demanding applications. Its durable design is well suited for harsh chemical process conditions or to meet the stringent demands of sterile biotech applications where CIP and SIP are used. These rugged electrodes lead the industry for fast and precise measurements, even after repeated autoclaving or sterilization cycles at 140 °C (284 °F). The InPro 3250 (i) family is available with an expanded selection of different pH-sensitive glass membranes. This guarantees the best possible measurement performance under the most diverse operating conditions, both in chemical and biotech processes. The platinum-auxiliary electrode (solution ground) which functions to eliminate ground loop problems, allows for use of advanced sensor diagnostics, or can be used as an ORP (redox) sensor.

### Specifications

pH range	0 – 14 pH InPro 3250 (i); 0 – 12 pH InPro 3253 (i); 1 – 11 pH InPro 3251 (i), InPro 3252
Temperature	0 to 100 °C (32 to 212 °F) InPro 3250 (i), InPro 3253 (i); –25 to 80 °C (–13 to 176 °F) InPro 3251 (i); 0 to 80 °C (32 to 176 °F) InPro 3252 (i)
Operating pressure	0 to 4 barg (0 to 58 psig)
Cable connection	ISM: K8S; Analog: VP
Process connection	Pg 13.5 thread
Reference system	Argenthal with silver-ion trap
Type of junction	Ceramic junction
Reference electrolyte	Pre-pressurized liquid
Lengths	120 mm, 225 mm, 325 mm, 425 mm
Shaft diameter	12 mm
Temperature sensor	ISM: digital Analog: Pt 100 or Pt 1000
Sterilizable	Yes, up to 140 °C (284 °F)
Autoclavable	Yes
pH membrane	Various by applications

### Certificates and Approvals

METTLER TOLEDO Quality Certificate,  
Pressure Equipment Directive guidelines (PED) 97/23/EC,  
ATEX: Ex ia IIC T6/T5/T4/T3 Ga/Gb,  
FM: IS Cl. I, II, III, Div 1, GR ABCDEFG/T6

### Intelligent Sensor Management (ISM)

pH electrodes with integrated ISM functionality allow Plug and Measure and advanced diagnostics. ISM simplifies the installation, handling and maintenance of measurement equipment. For more information see ISM introduction pages 10–11.

**Ordering Information**

ISM Electrodes	Length	Temp. Signal	Order Number		
<b>– with alkali resistant glass</b>					
InPro 3250i/SG	120mm	Digital	52 005 373		
InPro 3250i/SG	225mm	Digital	52 005 374		
InPro 3250i/SG	325mm	Digital	52 005 375		
InPro 3250i/SG	425mm	Digital	52 005 376		
<b>– for applications at low temperatures</b>					
InPro 3251 i/SG	120mm	Digital	52 003 693		
InPro 3251 i/SG	225mm	Digital	30 707 205		
<b>– for applications in hydrofluoric acid cont. media</b>					
InPro 3252i/SG	120mm	Digital	30 633 896		
InPro 3252i/SG	225mm	Digital	30 803 902		
<b>– with steam sterilizable glass</b>					
InPro 3253i/SG	120mm	Digital	52 005 377		
InPro 3253i/SG	225mm	Digital	52 005 378		
InPro 3253i/SG	325mm	Digital	52 005 379		
InPro 3253i/SG	425mm	Digital	52 005 380		
Analog Electrodes	Length	Temp. Signal	Order Number	Temp. Signal	Order Number
<b>– with alkali resistant glass</b>					
InPro 3250	120mm	Pt 100	52 002 547	Pt 1000	52 002 548
InPro 3250	225mm	Pt 100	52 002 552	Pt 1000	52 002 553
InPro 3250	325mm	Pt 100	52 002 554	Pt 1000	52 002 555
InPro 3250	425mm	Pt 100	52 002 556	Pt 1000	52 002 557
InPro 3250SG	120mm	Pt 100	52 002 558	Pt 1000	52 002 559
InPro 3250SG	225mm	Pt 100	52 002 560	Pt 1000	52 002 561
InPro 3250SG	325mm	Pt 100	52 002 562	Pt 1000	52 002 563
InPro 3250SG	425mm	Pt 100	52 002 564	Pt 1000	52 002 565
<b>– for applications at low temperatures</b>					
InPro 3251	120mm	Pt 100	52 002 585	–	–
InPro 3251	225mm	Pt 100	52 002 586	–	–
<b>– for applications in hydrofluoric acid cont. media</b>					
InPro 3252	120mm	Pt 100	52 002 587	–	–
InPro 3252	225mm	Pt 100	52 002 588	–	–
InPro 3252	250mm	Pt 100	52 002 589	–	–
<b>– with steam sterilizable glass</b>					
InPro 3253	120mm	Pt 100	52 002 566	Pt 1000	52 002 567
InPro 3253	225mm	Pt 100	52 002 568	Pt 1000	52 002 569
InPro 3253	250mm	Pt 100	52 002 570	–	–
InPro 3253	325mm	Pt 100	52 002 571	Pt 1000	52 002 572
InPro 3253	425mm	Pt 100	52 002 573	Pt 1000	52 002 574
InPro 3253SG	120mm	Pt 100	52 002 576	Pt 1000	52 002 577
InPro 3253SG	225mm	Pt 100	52 002 578	Pt 1000	52 002 579
InPro 3253SG	325mm	Pt 100	52 002 580	Pt 1000	52 002 581
InPro 3253SG	425mm	Pt 100	52 002 582	Pt 1000	52 002 583

**InPro Sensor Designation**

The last digit of the InPro designation indicates the

pH glass type:

00: High alkali glass (HA)

01: Low temperature glass (LoT)

02: Hydrofluoric acid resistant glass (HF)

03: Steam sterilizable glass (A41)

**Suitable Housings****p.**

InFit 761 e .....	122
InFit 762 e .....	124
InFlow .....	128
InDip .....	126
InTrac 777 e .....	133
InTrac 797 e .....	134
InTrac 781 .....	135
InTrac 785/787 .....	136

# InSUS 310i – Single-use pH Sensor

## Highest Integrity and Reliability



InSUS H30i mounted on sensor



### Features Overview

- Installation in standard weld-in bag ports
- Gamma and X-ray irradiation sterilizable
- 30-month shelf life
- Wetted parts in accordance with USP Class VI standards
- Round-edged protective guards around glass elements
- Mixed-mode operation: analog/digital with InSUS H30i
- Plug and Measure
- Reliable measurements
- Long in-process lifetime

The measurement principle of the InSUS™ 310i single-use pH sensor is based on proven potentiometric pH glass technology and offers identical reliability and accuracy as reusable pH sensors. The sensors are gamma and X-ray sterilizable and factory calibrated for convenient installation and operation in single-use process devices such as bioreactors and mixing bags for biopharmaceutical manufacturing. Their robustness ensures sensor and bag security during bag storage, transport, and startup.

For efficient process integration, the InSUS 310i is operated together with the reusable sensor head, InSUS H30i. This pairing offers the same connectivity and signal integration options as our reusable InPro ISM pH sensors. The identical operational interface leads to convenient and flexible usage of InSUS and InPro sensors in single-use devices, without any modification of the installed process transmitter or controller environment.

### Specifications

<b>InSUS 310i</b>	
Measurement principle	Potentiometric
Measurement range	pH 3 – 10
Response time	t90% < 20 s between pH 4 – 7
<b>Design</b>	
Body material	HDPE
Wetted O-ring	EPDM
Bag port (process connection)	Eldon James weld-in port with 1" barb
Cable connector	VP
Temperature probe	Pt1000
Signal interfaces	Analog, digital when paired with InSUS H30i sensor head
<b>Operating Conditions</b>	
Maximum shelf life	30 months (dry storage)
Sterilization method	Gamma and X-ray irradiation 25 ... 45 kGy
Temperature range during measurement	5 to 60 °C (41 to 140 °F)
Mechanical pressure resistance during measurement	Up to 2 barg/40 °C (29 psig/104 °F)
<b>Material Compliances</b>	
	USP 87, USP 88 Class VI (pre- and post-gamma), wetted polymers: absence of animal-derived materials, BPA, DEHP and Latex
<b>Certificates and Approvals</b>	
	METTLER TOLEDO Quality Certificate, CE, UKCA



## Ordering Information

Sensors	Quantity	Order Number
InSUS 310i	1	30 915 418
InSUS 310i	10	30 915 419

Sensor Head	Order Number
InSUS H30i	30 900 549

Transmitter	Order Number
M400 Type 1	30 374 111
M400 Type 2	30 374 112
M400 Type 3	30 374 113
M400 FF 4-wire	30 374 121
M800 Process, 2-channel	52 121 813
M800 Process, 4-channel	52 121 853
M800 Process, Profinet 2-channel	30 530 022
M800 Process, Ethernet/IP 2-channel	30 530 024
M800 Process, Profinet 1-channel	30 530 021
M800 Process, Ethernet/IP 1-channel	30 530 023



InSUS 310i installed in Eldon James weld-in bag port



### Did You Know

InSUS 310i sensors are also offered by leading single-use process device manufacturers as fully integrated component in their irradiation sterilized bioreactors.



### Did You Know

A special passivation treatment of the InSUS 310i reference electrode avoids loss of electrolyte during dry storage. This leads to the highest bag integrity with regards to preventing traces of electrolyte in empty bags.



# InPro 4010

## With Solid Polymer Electrolyte



The InPro 4010 is a low maintenance, economical pH sensor targeted towards industrial wastewater processes. It is available with an internal temperature sensor for accurate temperature compensation in a single unit. The solid polymer electrolyte is in direct contact with the sample medium, eliminating potential for junction fouling. The plastic body makes this a rugged sensor with reliable performance in contaminated liquids.

### Specifications

pH range	2 – 12 pH
Temperature	0 to 60 °C (32 to 140 °F)
Operating pressure	1 barg at 60 °C (15 psig @ 140 °F)
Cable connection	VP
Process connection	Pg 13.5 thread
Reference system	Argenthal
Type of junction	Open aperture, double junction
Reference electrolyte	Solid polymer
Lengths	120 mm
Shaft diameter	12 mm
Temperature sensor	Pt 100, Pt 1000 or none
Sterilizable	No
Autoclavable	No
pH membrane	General purpose glass
<b>Certificates and Approvals</b>	METTLER TOLEDO Quality Certificate

### Ordering Information

pH Electrodes	Length	Temperature Sensor	Order Number
InPro 4010	120 mm	Pt 100	52 000 511
InPro 4010	120 mm	Pt 1000	52 000 512
InPro 4010	120 mm	None	52 000 510

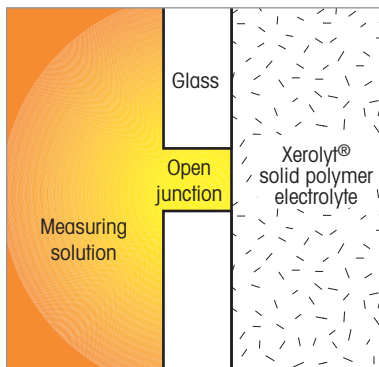

Open reference junction

### Features Overview

- Open aperture junction resists fouling
- Solid polymer electrolyte requires no refilling, reduces maintenance
- Double junction reference design resists poisoning
- Integral temperature sensor permits automatic temperature compensation
- Plastic body prevents breakage

Suitable Housings	p.
InFit 761e .....	122
InFit 762e .....	124
InFlow .....	128
InDip .....	126
InTrac 777 e .....	133
InTrac 785/787 .....	136

► [www.mt.com/InPro4010](http://www.mt.com/InPro4010)



# InPro 4260 (i)/InPro 4281 i

## Reliable, Long-lasting Electrodes



InPro 4260i

InPro 4281i

The InPro 4260 (i)/InPro 4281 i is a combined pH electrode and temperature sensor family designed for highly demanding chemical applications.

InPro 4260 (i)/InPro 4281 i electrodes feature Xerolyt™ Extra polymer reference electrolyte for precise pH measurement and longer lifetime, even under the most difficult industrial environments. Also available with Intelligent Sensor Management (ISM) for Plug and Measure and advanced diagnostics.

### Specifications

pH range	0–14 pH InPro 4260 (i); 1–11 pH InPro 4262(i), InPro 4281 (i)
Temperature	InPro 4260 (i), InPro 4281 i: 0 to 130°C (32 to 266 °F) InPro 4262 (i): 0 to 80°C (32 to 176 °F)
Operating pressure	15 barg @ 25 °C, 7 barg @ 130 °C (0 to 217 psig @ 77 °F, 101 psig @ 266 °F)
Cable connection	ISM: K8S; Analog: VP
Process connection	Pg 13.5 thread
Reference system	Argenthal
Type of junction	Open junction with direct contact to media
Reference electrolyte	Xerolyt Extra
Lengths	120 mm, 225 mm, 425 mm
Shaft diameter	12 mm
Shaft materials	InPro 426x (i): Glass; InPro 428x i: Titanium
Temperature sensor	ISM: Digital; Analog: Pt100 or Pt1000
Sterilizable	No
Autoclavable	No
pH membrane	Various by applications
Solution ground	InPro 426x (i): Platinum; InPro 428x i: Titanium

**Certificates and Approvals** METTLER TOLEDO Quality Certificate, Pressure Equipment Directive guidelines (PED) 97/23/EC, ATEX: Ex ia IIC T6/T5/T4/T3 Ga/Gb, FM: IS Cl. I, II, III, Div 1, GR ABCDEFG/T6 EN 10204-3.1 (InPro 4281 i)

### Intelligent Sensor Management (ISM)

pH electrodes with integrated ISM functionality allow Plug and Measure and advanced diagnostics. ISM simplifies the installation, handling and maintenance of measurement equipment. For more information see ISM introduction pages 10–11.

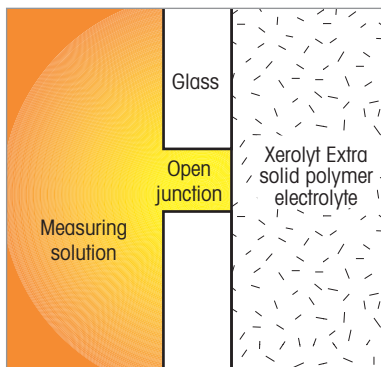

Open reference junction

### Features Overview

- Xerolyt Extra polymer electrolyte
- Open junction eliminates clogging
- Resistant to poisoning substances
- Expanded pH range covers 0–14 pH
- Resistant to solvents, strong acids and alkali
- Domed glass membrane impedes bubble formation for greater reliability
- Integral temperature sensor
- ATEX and FM certified for hazardous areas
- InPro 4281 i electrode is made with a rugged titanium shaft, providing exceptional chemical resistance and durability.
- InPro 4281 i features a flat pH membrane suited for fibers and high solids samples

► [www.mt.com/InPro4260](http://www.mt.com/InPro4260)



## Ordering Information

ISM Electrodes	Length	Temp. Signal	Order Number
InPro 4260 i/SG	120 mm	Digital	52 005 381
InPro 4260 i/SG	225 mm	Digital	52 005 382
InPro 4260 i/SG	425 mm	Digital	52 005 407
InPro 4262 i/SG	120 mm	Digital	30 018 467
InPro 4262 i/SG	225 mm	Digital	30 018 468
InPro 4281 i/SG	120 mm	Digital	30 301 402
InPro 4281 i/SG	225 mm	Digital	30 301 403
InPro 4281 i/SG	425 mm	Digital	30 301 404
<b>Analog Electrodes</b>			
InPro 4260	120 mm	Pt 100	52 002 986
InPro 4260	120 mm	Pt 1000	52 002 987
InPro 4260	225 mm	Pt 100	52 002 988
InPro 4260	225 mm	Pt 1000	52 002 989
InPro 4260	425 mm	Pt 100	52 002 992
InPro 4260	425 mm	Pt 1000	52 002 993
InPro 4260SG	120 mm	Pt 100	52 003 545
InPro 4260SG	120 mm	Pt 1000	52 003 546
InPro 4260SG	225 mm	Pt 100	52 003 547
InPro 4260SG	225 mm	Pt 1000	52 003 548
InPro 4262	120 mm	Pt 100	52 003 549
InPro 4262	120 mm	Pt 1000	52 003 550
InPro 4262	225 mm	Pt 100	52 003 551
InPro 4262	225 mm	Pt 1000	52 003 552
InPro 4262	425 mm	Pt 100	52 003 553
InPro 4262	425 mm	Pt 1000	52 003 554



### Did You Know

The InPro 4260 (i) family now also includes a hydrofluoric acid resistant glass formulation. The solution ground stabilizes the high impedance pH signal and provides an additional reference point for sensor diagnostics which can detect changes in performance due to influence of the media.



### InPro Sensor Designation

The last digit of the InPro designation indicates the pH glass type:

- 00 – High alkali glass (HA)
- 01 – Low temperature glass (LoT)
- 02 – Hydrofluoric acid resistant glass (HF)
- 03 – Steam sterilizable glass (A41)

### Suitable Housings

	p.
InFit 761 e.....	122
InFit 762 e.....	124
InFlow .....	128
InDip .....	126
InTrac 777 e.....	133
InTrac 797 e.....	134
InTrac 781 .....	135
InTrac 785/787 .....	136

## InPro 4550/InPro 4501

### The Rugged Solution



InPro 4550

InPro 4501 VP



The InPro 4550/4501 are rugged, low maintenance, combination pH/temperature sensors, designed to handle harsh chemical processes and industrial wastewater applications. The durable polymer body houses a solid polymer reference electrolyte, making the electrode robust from both physical and chemical attack. A solution ground prevents ground loop problems and allows advanced sensor diagnostics. The solid polymer electrolyte is in direct contact with the sample medium, eliminating potential for junction fouling. The InPro 4501's flat glass pH membrane is protected against breakage and is self-cleaning in flowing applications. The higher pressure/temperature specifications of the InPro 4550 target demanding applications with heavily contaminated media and aggressive industrial chemicals.

#### Specifications

	InPro 4550	InPro 4501
pH range	0–14 pH	1–14 pH
Temperature	0 to 130 °C (32 to 266 °F)	0 to 100 °C (32 to 212 °F)
Operating pressure	0 to 7 barg @ 130 °C (0 to 101 psig @ 266 °F)	0 to 6 barg @ 65 °C (0 to 87 psig @ 149 °F)
Cable connection	VP	VP or fixed cable
Process connection	1" MNPT	1" MNPT
Reference system	Argenthal	Argenthal
Type of junction	Open aperture, double junction	Open aperture, double junction
Reference electrolyte	Xerolyt Extra, solid polymer	Xerolyt Extra, solid polymer
Solution ground	Titanium	Titanium
Immersion length	72.5 mm (from front threads)	72.5 mm (from front threads)
Process connection	1" MNPT, 2-places	1" MNPT, 2-places
Temperature sensor	Pt 100, Pt 1000	Pt 100, Pt 1000
Body material	PPS (polyphenylene sulfide)	PVDF
Sterilizable	No	No
Autoclavable	No	No
pH membrane	High alkali glass (HA)	Flat membrane with low temperature glass (LoT)

Certificates and Approvals	METTLER TOLEDO Qual. Cert., Pressure Equipment Directive guidelines (PED) 97/23/EC, ATEX: Ex ia IIC T6/T5/T4/T3 Ga/Gb, FM: IS Cl. I, II, III, Div 1, GR ABCDEFG/T6	METTLER TOLEDO Qual. Cert.
----------------------------	--	----------------------------

#### Features Overview

- Withstands high process temperature and pressure (InPro 4550)
- PPS body is highly resistant to chemical attack (InPro 4550)
- Open aperture junction resists fouling
- Solid polymer electrolyte requires no refilling, reduces maintenance
- Dual NPT threads allow direct mounting into process
- Solution ground allows sensor diagnostics and eliminates ground loop problems

▶ [www.mt.com/InPro4550](http://www.mt.com/InPro4550)  
▶ [www.mt.com/InPro4501](http://www.mt.com/InPro4501)

**Ordering Information**

Electrode	Connection	Cable Length	Temperature Sensor	Order Number
<b>InPro 4550</b>				
InPro 4550	VarioPin	N/A	Pt100	52 002 401
InPro 4550	VarioPin	N/A	Pt1000	52 002 402
<b>InPro 4501</b>				
InPro 4501	VarioPin	N/A	Pt100	59 909 570
InPro 4501	VarioPin	N/A	Pt1000	59 909 571
InPro 4501	Fixed cable	3m (9.8ft)	Pt100	59 909 542
InPro 4501	Fixed cable	3m (9.8ft)	Pt1000	59 909 545
InPro 4501	Fixed cable w/BNC	3m (9.8ft)	Pt100	59 909 543
InPro 4501	Fixed cable	10m (32.8ft)	Pt100	59 909 546
InPro 4501	Fixed cable	10m (32.8ft)	Pt1000	59 909 548
<b>Accessory</b>				
Protective sleeve				52 401 808

For pH buffers, refer to "pH and Redox Accessories" section.

For cables, cable lengths and for terminating connectors, refer to "Cables" section on pages 146–149.



**Did You Know**

The protective sleeve for the InPro 4550 and InPro 4501 keeps the connection clean in dirty environments and protects the cable from stress.



Slotted tip protects the pH glass membrane



Flat glass pH membrane and solution ground

<b>Suitable Housings</b>	<b>p.</b>
InDip 550 .....	126

## InPro 4800 (i)/InPro 4881 i For Harsh Environments



InPro 4800 i



InPro 4881 i

The InPro 4800 (i)/InPro 4881 i is the top-of-the-line combined pH sensor family with integrated temperature sensor designed to handle dirty high-temperature and high-pressure chemical applications. The strong resistance to oxidizing media, solvents, acid and alkali solutions make it suitable for highly demanding industrial applications including chemical processing, chlor-alkali, pulp and paper, dyes and pigments, and sugar processing.

### Specifications

pH range	0–14 pH InPro 4800 (i); 1–14 pH InPro 4801 (i), InPro4881i 1–11 pH InPro 4802 (i)
Temperature	InPro 4800 (i), InPro 4801 (i), InPro 4881i: –5 to 130 °C (23 to 266 °F) InPro 4802 (i): 0 to 80 °C (32 to 176 °F)
Operating pressure	12 barg @ 130 °C (174 psig @ 266 °F)
Cable connection	ISM: K8S; Analog: VP
Process connection	Pg 13.5 thread
Reference system	Ag/AgCl system, pressure-compensated double gel-electrolyte chambers
Type of junction	Exterior: PTFE annular diaphragm Interior: Non-flow ceramic diaphragm
Reference electrolyte	Gel
Lengths	120 mm, 225 mm, 425 mm
Shaft diameter	12 mm
Shaft materials	InPro 480x (i): Glass InPro 488x i: Titanium
Temperature sensor	ISM: Digital; Analog: Pt 100 or Pt 1000
pH membrane	Various by applications
Solution ground	InPro 480x (i): Platinum InPro 488x i: Titanium
Sterilizable	No
Autoclavable	No
Solution ground	Platinum
Glass membrane	InPro 4800(i): Cylindrical, high alkali quality glass InPro 4801 (i)SG, InPro 4881i: Flat, low impedance quality glass InPro 4802(i): HF-resistant glass

### Certificates and Approvals

METTLER TOLEDO Quality Certificate  
Pressure Equipment Directive guidelines (PED) 97/23/EC,  
ATEX: Ex ia IIC T6/T5/T4/T3 Ga/Gb,  
FM: IS Cl. I, II, III, Div 1, GR ABCDEFG/T6  
EN 10204-3.1 (InPro 4281 i)

### Intelligent Sensor Management (ISM)

pH electrodes with integrated ISM functionality allow Plug and Measure and advanced diagnostics. ISM simplifies the installation, handling and maintenance of measurement equipment. For more information see ISM introduction pages 10–11.

[www.mt.com/InPro4800](http://www.mt.com/InPro4800)

## Ordering Information

ISM Electrodes	Length	Temp. Signal	Order Number
InPro 4800 i/SG	120 mm	Digital	52 005 383
InPro 4800 i/SG	225 mm	Digital	52 005 384
InPro 4800 i/SG	425 mm	Digital	52 003 748
InPro 4801 i/SG	120 mm	Digital	52 003 581
InPro 4801 i/SG	225 mm	Digital	30 069 539
InPro 4801 i/SG	425 mm	Digital	52 003 857
InPro 4802 i/SG	120 mm	Digital	52 003 696
InPro 4802 i/SG	225 mm	Digital	52 003 697
InPro 4881 i/SG	120 mm	Digital	30 301 405
InPro 4881 i/SG	225 mm	Digital	30 301 406
InPro 4881 i/SG	425 mm	Digital	30 301 407

## Analog Electrodes

InPro 4800	120 mm	Pt 100	52 002 124
InPro 4800	120 mm	Pt 1000	52 002 125
InPro 4800 SG	120 mm	Pt 100	52 003 541
InPro 4800 SG	120 mm	Pt 1000	52 003 542
InPro 4800	225 mm	Pt 100	52 002 126
InPro 4800	225 mm	Pt 1000	52 002 127
InPro 4800 SG	225 mm	Pt 100	52 003 543
InPro 4800 SG	225 mm	Pt 1000	52 003 544
InPro 4800	425 mm	Pt 100	52 002 129
InPro 4800	425 mm	Pt 1000	52 002 130
InPro 4801 SG	120 mm	Pt 100	52 002 131
InPro 4801 SG	120 mm	Pt 1000	52 002 132
InPro 4802	225 mm	Pt 100	52 002 718
InPro 4802 SG	225 mm	Pt 1000	52 003 398

## Features Overview

- High pressure/high temperature rating 12 barg @ 130 °C (174 psig @ 266 °F)
- Very long diffusion path using two electrolyte chambers
- PTFE annular junction repels dirt
- Resistant to strong oxidizing agents, solvents, acids and alkali, and to poisoning substances
- Integral temperature sensor
- InPro 4801 (i) and InPro 4881 i feature a flat pH membrane suited for fibers and high solids samples
- ATEX and FM certified for hazardous areas
- InPro 4881 i electrode is made with a rugged titanium shaft, providing exceptional chemical resistance and durability.



## InPro Sensor Designation

The last digit of the InPro designation indicates the pH glass type:

- 00 – High alkali glass (HA)
- 01 – Low temperature glass (LoT)
- 02 – Hydrofluoric acid resistant glass (HF)
- 03 – Steam sterilizable glass (A41)



## Quick Tip

A combination pH electrode should never be stored dry as this will dehydrate the electrode. Also, do not store an electrode in deionized water, rather, soak the electrode in the pH buffer or electrolyte recommended in the electrode manual.



## Did You Know

The InPro 4801 (i) SG electrode features a unique flat glass membrane ideal for applications with high fiber or solid concentrations.

## Suitable Housings

	p.
InFit 761 e .....	122
InFit 762 e .....	124
InFlow .....	128
InDip .....	126
InTrac 777 e .....	133
InTrac 781 .....	135
InTrac 785/787 .....	136

# InPro 4850 i

## For the Toughest Chlor-Alkali Processes



InPro 4850 i is a combination pH electrode featuring a sodium membrane glass that uses the sodium concentration in the process (brine) as a reference. The difference in electrical potential between the pH-glass and the sodium reference glass is converted into the pH value. The sodium reference system is highly resistant to chlorine and other oxidizing agents. This makes the sensor very well suited for the demanding process conditions in chlor-alkali production. Solution ground and shielding eliminate interference, and enable redox measurement. Digital signal conversion ensures 100% signal integrity and stability. Intelligent Sensor Management (ISM) technology simplifies sensor handling and reduces sensor lifecycle costs.

### Specifications

pH range	0 – 14 pH
Temperature	– 10 to 120 °C (14 to 248 °F)
Operating pressure	0 to 12 barg @120 °C (0 to 174 psig @ 248 °F)
Cable connection	ISM: K8S
Process connection	Pg 13.5 thread
Reference system	Sodium sensitive glass membrane
Type of junction	None
Lengths	120 mm, 225 mm
Shaft diameter	12 mm
Temperature sensor	Digital
Sterilizable	No
Autoclavable	No
pH membrane	High alkali glass (HA)
Min. Na <sup>+</sup> concentration	10 mg/L when pH > 7; 100 mg/L when 7 > pH > 2; 1 g/L when pH < 2
Storage solution	Storage solution buffer pH = 4.01/Na 3.9 M (P/N 52 004 103)

**Certificates and Approvals** METTLER TOLEDO Quality Certificate, Pressure Equipment Directive guidelines (PED) 97/23/EC ATEX: Ex ia IIC T6/T5/T4/T3 Ga/Gb, FM: IS Cl. I, II, III, Div 1, GR ABCDEFG/T6

### Intelligent Sensor Management (ISM)

pH electrodes with integrated ISM functionality allow Plug and Measure and advanced diagnostics. ISM simplifies the installation, handling and maintenance of measurement equipment. For more information see ISM introduction pages 10–11.

InPro 4850 i requires a near stable sodium concentration for the best measurement results. A 10% difference in brine concentration leads to 0.05 pH error.

### Features Overview

- Hermetically sealed reference system resistant to any effects from poisoning substances such as chlorine.
- Very high resistance to oxidizing media, solvents, and acid or alkali solutions.
- Reliable operation in processes with particularly high pressures and high temperatures.
- Platinum solution ground (SG) electrode enables redox (ORP) measurement and advanced sensor diagnostics, as well as preventing measurement errors due to ground potentials.

▶ [www.mt.com/InPro4850](http://www.mt.com/InPro4850)

### Ordering Information

pH Electrodes	Length	Order Number
InPro 4850i/SG	120mm	30 536 625
InPro 4850i/SG	225mm	30 536 627

pH Buffers	Order Number	Order Number
Designation	1 × 250 ml	6 × 250 ml
pH 2.00, 3.9M NaCl	52 004 100	52 004 101
pH 4.01, 3.9M NaCl	52 004 103	52 004 104
pH 7.00, 3.9M NaCl	52 004 106	52 004 107
pH 9.21, 3.9M NaCl	52 004 109	52 004 110

Redox Buffers	Order Number	Order Number
Designation	1 × 250 ml	6 × 250 ml
Redox buffer 320mV, 3.9M NaCl	30 104 917	–

### AK9 Coax Cables (–25 °C to 70 °C / –13 to 158 °F)

Designation	Connector	Cable Length	Order Number
AK9	open	1 m (3.3ft)	59 902 167
AK9	open	3 m (9.8ft)	59 902 193
AK9	open	5 m (16.4ft)	59 902 213
AK9	open	10m (32.8ft)	59 902 230
AK9	open	20m (65.6ft)	52 300 204

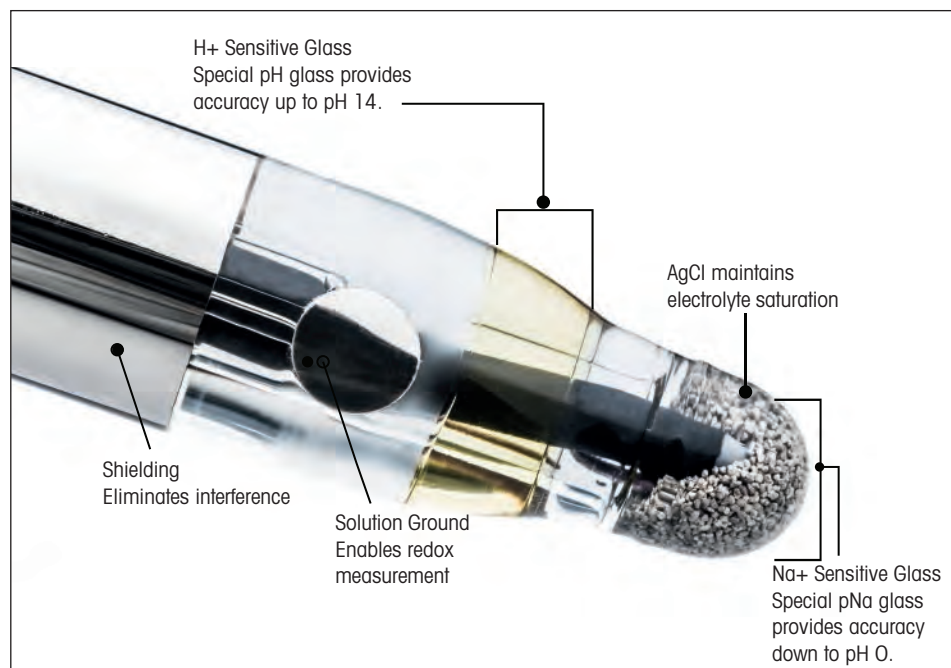

### Did You Know

InPro 4850i is the unique dual-membrane pH sensor with ISM digital signal for resisting chlorine and other oxidizing solutions.

Suitable Housings	p.
InFit 761 e.....	122
InFit 762 e/763 e.....	124
InFlow 751 .....	128
InTrac 787 .....	136



# Puncture pH Electrodes For Cheese and Meat Products



Puncture pH electrodes are specially designed for quick, accurate pH measurement in meat, sausage, cheese, and fruit. The rugged needle-shaped sensing membrane penetrates directly into the medium, without requiring time-consuming sample preparation. The solid polymer reference system eliminates clogging by fats and proteins using an open junction design. The non-refillable reference electrolyte reduces maintenance to a minimum.

### Specifications

pH range	2 – 11 pH
Temperature	0 to 80 °C (32 to 176 °F)
Response time	< 20 s (98 % between pH 4 to 7)
Materials of construction	Glass/PBT (shaft)
Membrane resistance	< 250 MΩ (25 °C/77 °F)
Type of membrane glass	LoT
Temperature sensor	None
Diaphragm	One open aperture junction
Reference system	Argenthal system
Reference electrolyte	Xerolyt Extra solid polymer
Cable and connections	S7-type
Shaft dimensions	Length: 25 mm Diameter: 6 mm
Sterilizable	No
Autoclavable	No

**Certificates and Approvals** METTLER TOLEDO Quality Certificate

### Ordering Information

Product Description	Order Number
Puncture electrode, polymer electrolyte	59 903 311
Puncture knife	59 900 386
Puncture electrode with knife	59 900 388
Cable, 1 m (3.3 ft), DIN connector for 1120/1140 meter	59 902 243
Cable, 1 m (3.3 ft), BNC connector	59 902 246
Cable, 1 m (3.3 ft), stripped ends	59 902 245
Buffer pouch, pH 4.01, pkt. of 30	51 302 069
Buffer pouch, pH 7.00, pkt. of 30	51 302 047
Buffer pouch, pH 9.21, pkt. of 30	51 302 070

### Features Overview

- Specially designed for direct pH measurement in cheese and meat
- Plastic shaft is FDA listed PBT
- Open aperture junction resists fouling
- Solid polymer electrolyte requires no refilling, reduces maintenance
- Optional puncture knife available for particularly hard cheeses and meats
- Use with 1120/1140 portable pH meter



### Did You Know

The pH measurement in cheese, meat, and fruit provides valuable information on product freshness and quality.

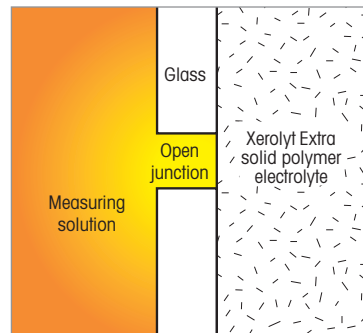

Open reference junction



# pH Buffers, Electrolytes, Cleaning and Storage Solutions

## Optimal Solutions for Your Process Analytics System



METTLER TOLEDO offers a wide selection of accessories to facilitate ease of use and maintenance of high accuracy pH measurement systems. These include buffers for pH calibration, electrolyte solutions for reference electrodes, and pH sensor simulators for evaluating measurement loops. Below is a partial listing of product accessories available for pH and redox systems.

### Ordering Information

pH and Redox Buffers	Volume	Order Number
<b>pH buffers</b>		
pH 4.01 buffer	250ml	51 340 057
pH 7.00 buffer	250ml	51 340 059
pH 9.21 buffer	250ml	51 300 193
pH 10.00 buffer	250ml	51 340 056
pH 2.00 buffer w/3.9M NaCl	250ml	52 004 100
pH 4.01 buffer w/3.9M NaCl	250ml	52 004 103
pH 7.00 buffer w/3.9M NaCl	250ml	52 004 106
pH 9.21 buffer w/3.9M NaCl	250ml	52 004 109
<b>Redox buffers</b>		
Redox buffer 220mV	6 × 250 ml	51 340 081
Redox buffer 468mV	6 × 30 ml	51 319 058
Redox buffer 320mV, w/3.9M NaCl	1 × 250 ml	30 104 917

### Reference Electrolyte Solutions

for Liquid-filled Electrodes	Volume	Order Number
Friscolyt B	250ml	51 340 053
Viscolyt	250ml	51 340 235
3M KCl	250ml	51 340 049

### Cleaning/Storage Solutions

	Volume	Order Number
pH electrode cleaner / proteins	250ml	51 340 068
Reactivating solution	6 × 30 ml	51 319 053
Storage solution, 3M KCl	250ml	51 340 049
Ceramic diaphragm cleaner	250ml	51 340 070



### Did You Know

The primary cause of pH measurement problems is a dirty ceramic diaphragm. Ingold has a complete line of pH cleaning solutions, as well as buffers and electrolyte to keep your electrode functioning properly.

## Pro2Go Portable pH/ORP Meter

Simple, Robust and Mobile



### Features Overview

- Supports analog, puncture and ISM sensors
- ISM diagnostics
- Calibration timer alerts when calibration is due
- Rugged housing for industrial use

### Other Highlights

- Measures pH, ORP and temperature
- IP67 rated housing
- Weatherproof USB interface for data exchange

For periodic pH or redox measurements, a mobile meter is the ideal choice. Designed for laboratory and industrial applications. The intuitive menu on Pro2Go™ ensures out-of-the-box operation for anyone. The meter's ergonomic design allows one-handed operation for both big and small hands. Its light weight makes measurement easy and convenient, even over lengthy periods of repeated measurement.

Pro2Go is compatible with both analog and digital ISM sensors. Its ISM features include Plug and Measure for error-free setup, and display of sensor diagnostics including DLI, ACT and TTM, so operators know when sensor calibration or replacement will be required.

The Pro2Go includes a datalogger that stores up to 2000 measurement data sets and computer interface for easy collection of data from the field.

### Specifications

Measurement parameters	pH, mV and temperature
Sensor type	Analog and ISM sensors
pH measuring range	–2.00 to +20.00 pH
mV range	–2000 to +2000 mV
Temperature input	NTC30K
Temperature measuring range	ATC: –5 to 130 °C (+23 to 266 °F) MTC: –30 to 130 °C (–22 to 266 °F)
Predefined buffer groups	9
Automatic buffer recognition	Yes
Calibration	1-point (offset), 2-point (slope and offset)
Supply voltage batteries	4 × LR6/AA 1.5 V Alkaline or 4 × HR6/AA 1.2 V NiMH rechargeable
Battery life (standby)	200 to 250 hrs
Supply voltage (USB powered)	Connection: Micro-USB Rating: 5 V DC, 100 mA
User interface	Graphic LC Display
Languages	10 (English, German, French, Italian, Spanish, Portuguese, Russian, Chinese, Korean and Japanese)
PC connection	Micro-USB for Data transfer and power
Memory size	2000 datasets (GLP conform)
Dimensions	Height × Width × Depth: 222 × 70 × 35 mm (8.74 × 2.76 × 1.38 inch)
Weight	0.29 kg (0.64 lb)
Material	• Housing: ABS/PC reinforced • Window: Polymethylmethacrylate (PMMA)
Enclosure rating	IP 67
Range of application	For indoor and outdoor use
Approvals	CAN/CSA-C22.2 No. 61010-1-12 UL Std. No. 61010-1 (3rd Edition)

► [www.mt.com/Pro2Go](http://www.mt.com/Pro2Go)

**Ordering Information**

<b>Pro2Go portable pH Meter</b>	<b>Order Number</b>
Pro2Go portable pH Meter including USB cable, sensor cable AK9-BNC/RCA for ISM sensors, rubber holster, wrist strap, CD with documentation and software, Declaration of conformity, Test certificate	30 386 271
<b>Accessories</b>	
Rubber holster	30 487 344
USB cable for PC connection	30 487 345
Power adapter for USB cable (to operate instrument without batteries)	30 487 346
Sensor cable AK9-BNC/RCA for ISM sensors	30 487 466
EasyDirect pH PC software	free download
<b>pH Buffer Solutions</b>	
Buffer pouch pH 4.01 (pkt. of 30)	51 302 069
Buffer pouch pH 7.00 (pkt. of 30)	51 302 047
Buffer pouch pH 9.21 (pkt. of 30)	51 302 070



Data transfer via USB interface.



**Did You Know**

You can get fast and simple data transfer with EasyDirect pH software via USB interface

## Dissolved Oxygen Measurement Systems High Reliability and Wide Application Coverage

**Real-time, continuous measurement of dissolved oxygen (DO) is central to the efficiency of many industrial processes. METTLER TOLEDO offers a range of robust DO sensors that utilize a well-established electrochemical measuring principle, plus sensors with the latest optical technology for applications where simplicity of operation is particularly important.**

### Measurement of dissolved oxygen

Proper oxygen levels are important in many processes in biotechnology, pharmaceutical development, food and beverage, chemical manufacturing, and in water and primary waste treatment. Control of dissolved oxygen helps ensure product quality, reduce costs, and provide maximum product yield.

### Optical measurement solutions from METTLER TOLEDO

The heart of the optical sensor is an oxygen-sensitive layer containing immobilized marker molecules. They absorb light from a light emitting diode and are able to release this energy as light at a different wavelength (fluorescence).

The fluorescence depends on the amount of oxygen that is present in the environment of the marker molecules. This effect allows determination of the oxygen concentration in the sample media.

### Advantages of optical oxygen technology

The optical oxygen sensors offer a highly accurate oxygen measurement with enhanced signal stability and fast response time. The sensors are fully steam sterilizable, autoclavable and fulfill all industrial requirements for hygienic design and traceability. Since no electrolyte exchange or sensor polarization is needed, sensor main-

tenance is easy and less error-prone. This sensor type takes advantage of ISM technology.

### Electrochemical oxygen sensors

The large portfolio of Ingold amperometric sensors fulfill the highest industrial requirements in performance and design to accommodate virtually any application. They are equipped with the unique ISM technology.

**ISM**



InPro 6860 i HD  
with Anti-Bubble OptoCap



InPro 6960 i  
InPro 6970 i



InPro 6900 i  
InPro 6950 i



InPro 6800  
12mm and 25mm



InSUS 607

## Application guide for dissolved oxygen sensors

	Amperometric hygienic sensors			Optical hygienic sensors			Non hygienic sensors		
	InPro 6800	InPro 6850i	InPro 6900/InPro 6900i	InPro 6860i mA/InPro 6860i mA HART (MODBUS)	InPro 6960i	InPro 6970i	InPro 6050	InSUS 607	Optical InTap
<b>Industrial processes</b>									
<b>Pharmaceutical Industry</b>									
Biotechnological applications	•	•	•					•	
<b>Chemical Industry</b>	•	•							
<b>Beverage Industry</b>	•	•	•	•	•	•			•
<b>Wastewater applications</b>							•		

### Transmitter selection

Several Ingold transmitters are available to work in conjunction with our amperometric and optical sensors including the multi-parameter transmitter lines M100, M200, M300, M400 and M800.

### Housings and socket selection

The widest selection of stationary, retractable and submersion housings is provided to match virtually any process connection. Vessel ports or

sockets are used as entry points for the oxygen sensor. METTLER TOLEDO provides a host of ports including the original Ingold 25 mm port which is recognized as a standard in the biotech and pharmaceutical industries.

### Professional service and validation

Sensor service includes rebuilding, cleaning, testing, and recertification of your Ingold sensor, done quickly and efficiently to minimize downtime.

Validation and testing of oxygen equipment is done with equipment traceable to NIST.

### Integration flexibility

Optical sensors can be integrated directly using their analog (mA-HART) or digital (Modbus) interface.

## InPro 6860 i Optical Oxygen Sensor

### Easy Handling, Exceptional Performance

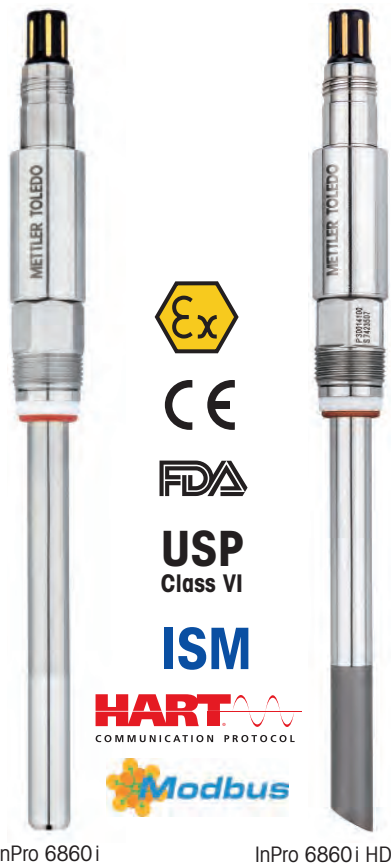

InPro 6860 i

InPro 6860 i HD

#### Features Overview

- Plug and Measure
- Outstandingly fast service
- Immediate availability without need of polarization
- No electrolyte handling
- Low detection limit
- Highest signal stability
- Fast response time
- All wetted parts in accordance to FDA and USP Class VI-standards
- Sterilizable and autoclavable
- Hygienically polished surface
- Digital ISM technology

Combining innovative ISM technology with high-end optical measurement, METTLER TOLEDO offers optical oxygen sensors fully suitable for biopharma applications. The InPro 6860 i offers highly accurate oxygen measurement with enhanced stability, and easy handling without electrolyte change or time-consuming polarization procedures. The sensor is equipped with a digital interface (digital ISM and Modbus RTU) plus analog output signal for direct integration into existing biocontrollers, analog transmitters and into process environments including HART communication protocol.

#### Integrates ISM technology

With ISM, the installation, maintenance, and safety of the system is drastically improved. All sensor relevant data are stored in the sensor. Pre-calibrated systems transfer the data automatically to the transmitter and are therefore ready for measuring within seconds. Changes in the measuring system are monitored via the Dynamic Lifetime Indicator. With these features, error-free and safe operation of the sensor and the transmitter is assured. For more information see ISM introduction pages 10–11.

#### Specifications

##### Performance

Operating range	0 ppb to saturation (3 bar)
Accuracy	$\leq \pm [1\% + 8 \text{ ppb}]$
Response time at 25 °C (77 °F) (Air → N <sub>2</sub> )	98% of final value in <90s

##### Construction

Measuring principle	Fluorescence quenching
Cable connection	VP8
Connector design	Straight
Process connection	Pg 13.5
Sensor body	316 L stainless steel
OptoCap membrane material	PTFE
Surface roughness of wetted parts	N5/R <sub>0</sub> 16 (R <sub>0</sub> = 0.4 μm/ 16 μin)
O-ring material	EPDM (FDA positive listed)
Sensor diameter	12 mm

##### Working Conditions

Temperature compensation	Automatic
Measuring temperature range	5 to 60 °C (41 to 140 °F)
Environmental temperature range	InPro 6860 i: –20 to 140 °C (–4 to 284 °F) (sterilizable, autoclavable)

Operating pressure	0.2 to 6 bar (2.9 to 87 psi absolute)
Design pressure	Maximum 6 bar (87 psi absolute)

##### Certificates and Approvals

METTLER TOLEDO Quality Certificate  
 FDA/USP Class VI, 3.1, N5/R<sub>0</sub>16  
 ATEX



## Ordering Information

Sensor	Length	nA	mA; HART	Modbus	OptoCap Version	Order Number
InPro 6860i nA	120 mm	•		•	BT02T	30 014 100
InPro 6860i nA	220 mm	•		•	BT02T	30 014 101
InPro 6860i nA	320 mm	•		•	BT02T	30 014 102
InPro 6860i nA	420 mm	•		•	BT02T	30 014 103
InPro 6860i nA HD	120 mm	•		•	BT02THD	30 449 703
InPro 6860i nA HD	220 mm	•		•	BT02THD	30 449 704
InPro 6860i nA HD	320 mm	•		•	BT02THD	30 526 901
InPro 6860i nA HD	420 mm	•		•	BT02THD	30 526 902
InPro 6860i nA HD	590 mm	•		•	BT02THD	30 526 903
InPro 6860i mA	120 mm		•	•	BT02T	30 129 734
InPro 6860i mA	220 mm		•	•	BT02T	30 129 735
InPro 6860i mA	320 mm		•	•	BT02T	30 129 736
InPro 6860i mA	420 mm		•	•	BT02T	30 129 737
InPro 6860i mA HD	120 mm		•	•	BT02THD	30 449 705
InPro 6860i mA HD	220 mm		•	•	BT02THD	30 449 706
InPro 6860i mA HD	320 mm		•	•	BT02THD	30 526 900
InPro 6860i mA HD	420 mm		•	•	BT02THD	30 532 157
InPro6860i mA FHD	120 mm		•	•	BT02TFHD	30 847 367
InPro6860i nA FHD	120 mm	•		•	BT02TFHD	30 847 509
InPro6860i mA FHD	220 mm		•	•	BT02TFHD	30 848 618
InPro6860i nA FHD	220 mm	•		•	BT02TFHD	30 848 619
InPro6860i mA FHD	320 mm		•	•	BT02TFHD	30 848 620
InPro6860i nA FHD	320 mm	•		•	BT02TFHD	30 848 621
InPro6860i mA FHD	420 mm		•	•	BT02TFHD	30 848 622
InPro6860i nA FHD	420 mm	•		•	BT02TFHD	30 848 623
InPro6860i nA FHD	590 mm	•		•	BT02TFHD	30 848 624

Transmitter	Order Number
M400 Type 2	30 374 112
M400 Type 3	30 374 113
M400/2H	30 025 514
M400/2(X)H	30 025 515
M400 FF	30 026 616
M400 FF 4-wire	30 374 121
M400 PA	30 026 617
M800 Process, 1-channel	30 026 633
M800 Process, 2-channel	52 121 813
M800 Process, 4-channel	52 121 853
M800 Process, 1-channel SST	30 246 551
M800 Process, 2-channel SST	30 246 552
M800 Process, 4-channel SST	30 246 553

InPro 6860i Consumables	Order Number
OptoCap BT02T (Standard OptoCap)	30 018 857
OptoCap BT02THD (Angled Anti Bubble OptoCap; for vertical Installations)	30 302 172
OptoCap BT02TFHD (Flat Anti-Bubble OptoCap; for Horizontal Installations)	30 819 545

Accessories	Order Number
iLink Multi (incl. automated humidity and pressure compensation)	30 130 631
iLink Multi Cable/Set oDO (Cable set for all oDO sensors)	30 355 582
Housing Retrofit kit	52 403 811
Power supply in case of need for analog installation of InPro 6860i	30 014 119



### Did You Know

The optical oxygen sensors can be used in conjunction with all M400 and M800 transmitters as well as with existing analog and digital Modbus installations.

## OptoCap replacement



**OptoCap – BT02T**  
electropolished, delivers a hygienically polished surface.

**OptoCap – BT02THD** stabilizes the measurement signal by its hydrophilic surface by avoiding air bubble interference. Angled Version optimized for Benchtop Fermenter installation where sensors are installed vertically.



**OptoCap – BT02TFHD** stabilizes the measurement signal by its hydrophilic surface by avoiding air bubble interference. Flat Version for use with large bioreactors where sensors are installed horizontally.



### Did You Know

Oxygen bubble interference can be a common issue when optical oxygen sensors are installed vertically. The new OptoCap (BT02THD) with its proprietary design has a surface treatment that efficiently reduces these interferences. This allows greater production control leading to consistent yield, batch to batch.

Suitable Housings	p.
InFit 761 e.....	122
InTrac 777 e.....	133
InTrac 797 e.....	134
InTrac 781 .....	135
InTrac 785 e.....	136

## InSUS 607/InSUS H60i – Single-use Sensor

### Flexible Integration and Operation



InSUS 607 sensor



InSUS H60i sensor head

#### Features Overview

- Installation in standard weld-in bag ports
- Gamma and X-ray irradiation sterilizable
- Three-year shelf life
- Wetted parts in accordance with USP Class VI standards
- No need for autoclaving
- Plug and Measure
- Digital and analog signal interfaces
- Long term measurement stability

The measurement principle of the InSUS 607 single-use dissolved oxygen (DO) sensor is based on proven optical spot technology and offers identical reliability and accuracy as METTLER TOLEDO's reusable optical DO sensors. These single-use sensors are gamma and X-ray sterilizable for secure installation and operation in single-use process devices such as bioreactors, harvesting, and storage bags for biopharmaceutical manufacturing.

An InSUS 607 sensor is operated together with a reusable sensor head, InSUS H60i. This pairing offers the same connectivity and signal integration options as our reusable InPro 6860i optical DO sensor (see pages 44/45). The identical operational interface leads to convenient and flexible usage of InSUS and InPro sensors in single-use devices, without modifying the installed process transmitter or controller environment.

#### Specifications

InSUS 607	
Measurement principle	Optical (fluorescence quenching)
Measurement range	0 ... 250 % air
Accuracy	< 2.5 % for the range 50 ... 100 % air after 1-point calibration in 100 % air, < 1 % after 2-point calibration in 100 % air and 0 % oxygen
Response time	25 °C (77 °F) air → nitrogen, t98 % < 30 s

Design	
Body material	HDPE
Wetted O-ring	EPDM
Wetted spot material	Silicone
Bag port (process connection)	Eldon James weld-in port with 1" barb

Operating Conditions	
Maximum shelf life	36 months (dry storage)
Sterilization method	Gamma and X-ray irradiation 25 ... 45 kGy
Temperature range during measurement	5 ... 60 °C (41 ... 140 °F)
Mechanical pressure resistance during measurement	Up to 2 barg / 40 °C (29 psig / 104 °F)

Material compliances	
	USP 87, USP 88 Class VI (pre- and post-gamma), wetted polymers: absence of animal-derived materials, BPA, DEHP and Latex

InSUS H60i	
Power Supply	24 VDC, 0.1 A

Design	
Shaft and housing material	316L stainless steel
Shaft diameter	12 mm
Total length when mounted on InSUS 507	235 mm (9.25")
Cable connection	VP8
Integrated temperature probe	Pt1000

Signal Interfaces	
Digital	ISM and Modbus RTU
Analog	4 – 20 mA/HART or nano Ampere (nA)
Certificates and Approvals	METTLER TOLEDO Quality Certificate, CE, UKCA

► [www.mt.com/InSUS\\_DO](http://www.mt.com/InSUS_DO)





## Ordering Information

Sensors	Quantity	Order Number
InSUS 607	1	30 778 198
InSUS 607	10	30 778 199

Sensor Head	Signal Outputs	Order Number
InSUS H60i nA	ISM/Modbus RTU, nA	30 788 856
InSUS H60i mA	ISM/Modbus RTU, 4–20 mA	30 788 857

Transmitter	Order Number
M100 SM RS485	30 365 367
M400 Type 2	30 374 112
M400 Type 3	30 374 113
M400/2H	30 025 514
M400/2(X)H	30 025 515
M400 FF	30 026 616
M400 FF 4-wire	30 374 121
M400 PA	30 026 617
M800 Process, 1-channel	30 026 633
M800 Process, 2-channel	52 121 813
M800 Process, 4-channel	52 121 853
M800 Profinet, 1-channel Process	30 530 021
M800 Profinet, 2-channel Process	30 530 022
M800 Process, 1-channel Ethernet/IP	30 530 023
M800 Process, 2-channel Ethernet/IP	30 530 024

Accessories	Order Number
Power supply set 24 VDC	30 014 119



### Did You Know

InSUS 607 sensors are also offered by leading single-use process device manufacturers as a fully integrated component in their irradiation sterilized bioreactors.



### Did You Know

METTLER TOLEDO Ingold offers sensors in single-use format for monitoring and control of processes for the production of monoclonal antibodies, mRNA vaccines, and viral vectors for cell therapies.



InSUS H60i mounted on InSUS 607, protective cap mounted on clip holder

## Powering Accessories for InPro 6860 i Digital Sensor Integration

Combined oDO & pH Junction Box with Bluetooth connectivity



InPro 6860 i  
Adapter T82

InPro 6860 i  
Adapter VP6

### Features Overview

- Uses existing cables to biocontrollers
- Simplified installation
- Flexible powering options

The J-Box BTLE simplifies biocontroller upgrades to advanced InPro 6860 i optical oxygen and digital ISM pH sensors without complicated wiring or grounding requirements. Using a shared power supply, the J-Box BTLE connects both oxygen and pH sensors to biocontrollers using existing and standard T-82 (for oxygen) and AK9 (for pH) cables. Measurement signals are sent from the J-Box as nA for oxygen and mV for pH providing universal connectivity to biocontrollers. Standard 1 or 3 meter cables are available for connection from the J-Box BTLE to the oxygen and pH sensors.

The J-Box BTLE is equipped with a Bluetooth interface. It connects to ISMCore and iSense Mobile for calibration, maintenance and diagnostic purposes.

The InPro 6860 i Adapter provides functionality with a direct connection to InPro 6860 i optical oxygen sensors. 24 V DC is provided through a standard 2.1 mm 5.5 mm female barrel connection with existing T-82 cables connected to the adapter's outlet.

### Flexible installation choices

The J-Box BTLE is ideal for installing ISM optical oxygen and pH sensors onto the head plate of a reactor when space is limited.

The InPro 6860 i Powered Adapter is ideal for installations with sufficient space on the head plate of a reactor and where only optical oxygen is required.

### Specifications

#### Performance

Minimum input power requirement	24 V DC (min. 800 mW, 0.03 A)
Power connection	2.5 mm × 5.5 mm male barrel mating to a 2.1 mm × 5.5 mm female barrel connection

#### Combined J-Box Sensor Connections

To InPro 6860 i sensor	Male VarioPin
To ISM pH sensor	Male BNC
Simulated O <sub>2</sub> (nA) to biocontroller	Male T-82 connector* wired for temperature
Simulated pH (mV) to biocontroller	Male K9/K8S

#### InPro 6860 i Adapter Connections

To InPro 6860 i sensor	Female VarioPin
To biocontroller	Male T-82 connector wired for temperature

\* The T-82 Adapter is also available with a VP6 connector.

### Details

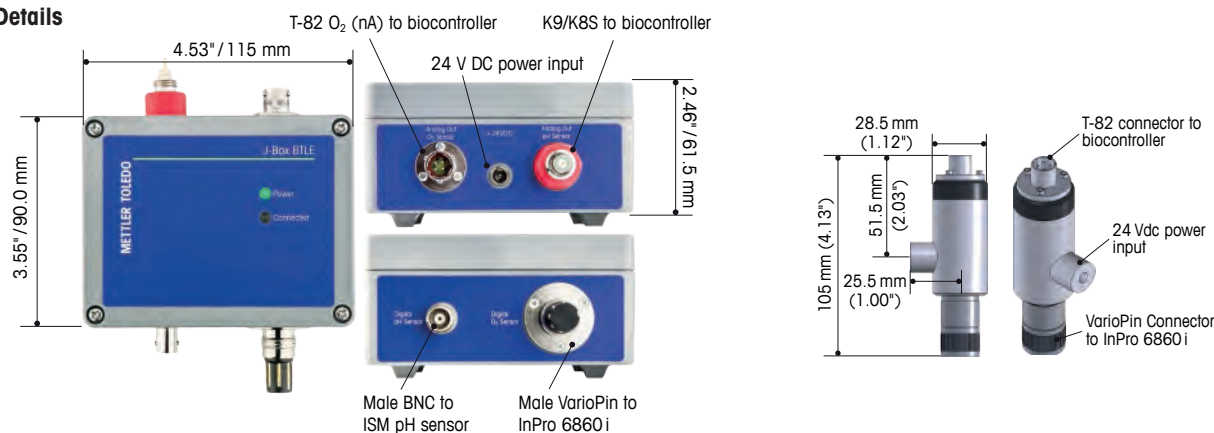

### Ordering Information

Product Description	Order Number
J-Box BTLE	30 365 368
InPro 6860i T-82 Adapter for Biocontroller Retrofit	30 083 984
InPro 6860i VP6 Adapter for Biocontroller Retrofit	30 083 985
Power supply 24 V 0.75 A angled plug	30 323 961

#### O<sub>2</sub> Accessory Cables (for J-Box BTLE to InPro 6860i sensor)

Product Description	Order Number
Cable, VP-8, 1 m, Female VP	30 094 370
Cable, VP-8, 3 m, Female VP	30 094 371

#### ISM pH Accessory Cables (for J-Box BTLE to ISM pH sensor)

Product Description	Order Number
Cable, AK9, 1 m, Female BNC	59 902 168
Cable, AK9, 3 m, Female BNC	59 902 194

#### Biocontroller Retrofit Cables for InPro 6860i

VP6 (analog)	Order Number	VP8 (digital)	Order Number
All standard VP6 (analog)	see table, pp. 146/147	VP8-ST, 1 m (3.3 ft)	52 300 353
VP6 Connector BNC, 3 m (9.9 ft)	30 032 731	VP8-ST, 3 m (9.9 ft)	52 300 354
VP6 Connector LEMO, 3 m (9.9 ft)	30 032 733	VP8-ST, 5 m (16.4 ft)	52 300 355
VP6 Connector Lumberg, 3 m (9.9 ft)	30 032 735	VP8-ST, 10 m (32.8 ft)	52 300 356
		VP8-ST, 15 m (49.2 ft)	52 300 357
		VP8-ST, 20 m (65.6 ft)	52 300 358
		VP8-ST, 35 m (114.8 ft)	52 300 359



#### Did You Know

The J-Box BTLE is an ideal solution to retrofit biocontrollers with InPro 6860i and ISM pH sensors. The integral 2.5 mm × 5.5 mm barrel connector enables simplified power connection. METTLER TOLEDO recommends using a three-pronged grounded 24 V DC power supply for best performance.



#### Additional Cable Options

METTLER TOLEDO offers a wide variety of oxygen and pH cables for connecting the J-Box BTLE or InPro 6860i Adapter to your biocontrollers. Please contact your local representative to learn more about our available options.

## InPro 6960 i/InPro 6970 i Optical Oxygen Sensor

### Reliable and Intelligent



#### Features Overview

- Plug and Measure
- Fast maintenance in less than 1 minute
- Immediate availability, no need for polarization
- No electrolyte handling
- Low detection limit
- Highest signal stability
- Fast response time
- All wetted parts in accordance to FDA and USP Class VI-standards
- Fully CIP and SIP resistant
- Hygienically polished surface finish of N5/R<sub>a</sub>16 (R<sub>a</sub>=0.4 μm/16 μin)
- Digital ISM technology

Optical technology in 12 mm design is available for challenging brewery applications such as filler line measurement. These optical sensors offer high performance together with reduced and easier maintenance. The outstanding measurement performance with low detection limit, minimum drift and short response time improves oxygen monitoring and helps to reduce out of spec production. The easy maintenance without liquid handling and polarization increases the availability of the measuring system.

#### ISM

ISM technology helps to make optical oxygen measurement simple and more reliable. Thanks to the Dynamic Lifetime Indicator (DLI) and Adaptive Calibration Timer (ACT), maintenance planning becomes easy and the risk of sensor failures during production time is significantly reduced. For more information see ISM introduction pages 10–11.

#### Specifications

##### Performance

Operating range	InPro 6960 i: 0 ppb to 25 ppm
	InPro 6970 i: 0 ppb to 2000 ppb
Accuracy	InPro 6960 i: $\leq \pm [1 \% + 8 \text{ ppb}]$
	InPro 6970 i: $\leq \pm [1 \% + 2 \text{ ppb}]$
Response time at 25 °C (77 °F) (Air → N <sub>2</sub> )	98 % of final value in <20 s
Residual signal in oxygen-free medium	<0.025 % of the signal in ambient air

##### Construction

Measuring principle	Fluorescence quenching
Cable connection	5-Pin
Connector design	Straight
Process connection	Pg 13.5
Sensor body	316L stainless steel
Membrane material	Silicone
Surface roughness of wetted parts	N5/R <sub>a</sub> 16 (R <sub>a</sub> =0.4 μm/16 μin)
O-ring material	EPDM (FDA positive listed)
Sensor diameter	12 mm

##### Working Conditions

Temperature compensation	Automatic
Measuring temperature range	–5 to 40 °C (23 to 104 °F)
Environmental temperature range	0 to 121 °C (32 to 250 °F) (sterilizable)
Operating pressure	0.2 to 12 bar (2.9 to 174 psi absolute)
Design pressure	Maximum 12 bar (174 psi absolute)

##### Certificates and Approvals

METTLER TOLEDO Quality Certificate, FDA/USP Class VI, 3.1, N5/R<sub>a</sub>16

- ▶ [www.mt.com/InPro6960i](http://www.mt.com/InPro6960i)
- ▶ [www.mt.com/InPro6970i](http://www.mt.com/InPro6970i)

**Ordering Information****12 mm InPro 6960 i/6970 i**

Sensor	Length	Order Number
InPro 6960 i	120 mm	52 206 500
InPro 6960 i	220 mm	52 206 501
InPro 6960 i	320 mm	52 206 502
InPro 6970 i	120 mm	52 206 393
InPro 6970 i	220 mm	52 206 394
InPro 6970 i	320 mm	52 206 395

**Transmitter**

M400 Type 3	30 374 113
M400/2H	30 025 514
M400/2(X)H	30 025 515
M400 FF	30 026 616
M400 PA	30 026 617
M800 SST, 1-channel	30 246 551
M800 SST, 2-channel	30 246 552
M800 Process, 1-channel	30 026 633
M800 Process, 2-channel	52 121 813
M800 Process, 4-channel	52 121 853

**InPro 6960 i/6970 i Consumables**

OptoCap BW01 for 6960 i	52 206 509
OptoCap BR01 for 6970 i	52 206 403
O-ring set	52 206 252

**Sensor Cables**

2 m (6.6 ft)	52 300 379
5 m (16.4 ft)	52 300 380
10 m (32.8 ft)	52 300 381
15 m (49.2 ft)	52 206 422

**Accessories**

iLink-RS485 Sensor Cable for ISM Core	52 300 399
iLink Multi	30 130 631
iLink Multi cable set oDO	30 355 582
Housing retrofit kit	52 403 811
Maintenance cap	52 206 251

**Did You Know**

In conjunction with the M400, the **InPro 6960 i** offers an easy-to-use solution for high ppm measurements as found in wort aeration monitoring.

**Other Highlights**

- No electrolyte necessary
- No polarization required
- Easy maintenance

**Did You Know**

In conjunction with the M400, the **InPro 6970 i** offers an easy-to-use solution for low ppb measurements throughout brewing and filler lines.

**OptoCap replacement**

One piece O-ring-free OptoCap

**Suitable Housings**

InFit 761 e.....	122
InTrac 777 e.....	133
InTrac 797 e.....	134

# Dissolved Oxygen Sensors

Proven Quality, Top Performance

Dissolved Oxygen

## InPro 6800/InPro 6850 i (12 & 25 mm) For Accurate Oxygen Measurement



InPro 6850 i    InPro 6800

### Features Overview

- Revolutionary “Quick Disconnect” system allows for service in seconds
- Detection limit down to 6 ppb
- Accurate measurement and quick response
- Long lasting and easy to maintain membranes
- FDA positive listed materials of construction
- Hygienically polished surface finish of N5/R<sub>0</sub>16 (R<sub>a</sub>=0.4 μm/16 μin)
- EHEDG certified for cleanability and 3A compliant
- Wetted O-rings comply with FDA and USP Class VI standards
- Autoclavable and steam sterilizable

The InPro 6800 dissolved oxygen sensor with 12 or 25 mm diameter body provides maximum accuracy and ultimate cleanability for vessels with limited space or in containers with smaller volumes. The sensor is available with the state-of-the-art VP connector or T-82 connector in straight or angled versions. A durable 316L stainless steel construction allows for CIP, steam sterilization or autoclaving in place, and the high sensor finish virtually eliminates contamination of the process. Ingold’s PTFE/silicone membranes have been designed with an internal steel mesh that makes the membrane more rugged and dramatically increases membrane life.

### Specifications

#### Performance

Operating range	0 ppb to saturation (5 bar)
Accuracy	≤ ± [1 % +6 ppb]
Response time at 25 °C (77 °F)	98 % of final value in < 90 s
Polarization time	InPro 6800: 1 h; InPro 6850i: 6 h
Sensor signal in air at 25 °C (77 °F)	50 to 110 nA
Residual signal in oxygen-free medium	< 0.1 % of the signal in ambient air

#### Construction

Measuring principle	Amperometric Clark electrode
Cable connection	Analog VarioPin (IP 68), Digital K8S (IP 68)
Connector design	Straight or angled
Process connection	Pg 13.5 (12 mm); Ingold (25 mm)
Sensor body	316L stainless steel
Membrane material	PTFE/Silicone/PTFE (reinforced with steel mesh)
Surface roughness of wetted parts	N5/R <sub>0</sub> 16 (R <sub>a</sub> = 0.4 μm/16 μin)
O-ring material	Silicone (FDA and USP Class VI positive listed)
Sensor diameter	12 mm/25 mm

#### Working Conditions

Temperature compensation	Automatic
Measuring temperature range	0 to 80 °C (32 to 176 °F)
Environmental temperature range	–5 to 140 °C (23 to 284 °F) (steriliz., autocl.)
Operating pressure	0.2 to 6 bar (2.9 to 87 psi absolute)
Design pressure	Maximum 12 bar (174 psi absolute)

#### Certificates and Approvals

METTLER TOLEDO Quality Certificate, EHEDG, FDA/USP Class VI, 3.1, N5/R<sub>0</sub>16,  
ATEX: Ex ia IIC T6/T5/T4/T3 Ga/Gb,  
Ex ia IIIC T69 °C/T81 °C/T109 °C/T161 °C Da/Db  
FM: IS Cl. I, II, III, Div 1, GR ABCDEFG/T6

#### Intelligent Sensor Management (ISM)

InPro 6850 i sensors with integrated ISM functionality allow Plug and Measure and advanced diagnostics. ISM simplifies the installation, handling and maintenance of measurement equipment. For more information see ISM introduction pages 10–11.

#### Other Highlights

- Small 12 or 25 mm diameter saves valuable space
- Pg 13.5 threads for interface into housings
- Comes with either watertight VP connector (IP 68) or T-82 connector
- Ingold 25 mm sensor design recognized as a standard in the industry
- Cap nut allows for easy interface to Ingold ports

► [www.mt.com/InPro68x0](http://www.mt.com/InPro68x0)

## Ordering Information

### 12 mm InPro 6800/6850 i DO Sensor Series

Sensor	Length	Connector	VP Number	ISM Number
InPro 6800/6850 i	70 mm	Straight	52 200 964	52 206 118
InPro 6800/6850 i	120 mm	Straight	52 200 965	52 206 119
InPro 6800/6850 i	220 mm	Straight	52 200 966	52 206 120
InPro 6800/6850 i	320 mm	Straight	52 200 967	52 206 121
InPro 6800/6850 i	420 mm	Straight	52 200 968	52 206 122
InPro 6810	70 mm	Angled	52 200 969	
InPro 6810	120 mm	Angled	52 200 970	
InPro 6810	220 mm	Angled	52 200 971	
InPro 6810	420 mm	Angled	52 200 973	

### 12 mm InPro 6800 DO Sensor Series (T-82 Connector)

Sensor	Length	Connector	Order Number
InPro 6820	120 mm	Straight T-82	52 201 012
InPro 6820	220 mm	Straight T-82	52 201 013
InPro 6820	320 mm	Straight T-82	52 201 014
InPro 6820	420 mm	Straight T-82	52 201 015
InPro 6830	120 mm	Angled T-82	52 201 016
InPro 6830	220 mm	Angled T-82	52 201 017
InPro 6830	320 mm	Angled T-82	52 201 018
InPro 6830	420 mm	Angled T-82	52 201 019

### 25 mm InPro 6800/6850 i DO Sensor Series

Sensor	Length	Connector	VP Number	ISM Number
InPro 6800/6850 i	80 mm	Straight	52 200 974	52 206 123
InPro 6800/6850 i	160 mm	Straight	52 200 975	52 206 124
InPro 6800/6850 i	260 mm	Straight	52 200 976	52 206 125
InPro 6800/6850 i	360 mm	Straight	52 200 977	52 206 126
InPro 6810	80 mm	Angled	52 200 978	
InPro 6810	100 mm	Angled	52 200 982	
for B. Braun ports	EPDM O-rings			
InPro 6810	160 mm	Angled	52 200 979	
InPro 6810	260 mm	Angled	52 200 980	
InPro 6810	360 mm	Angled	52 200 981	

For available sensors for B. Braun ports please ask your local sales organization.

### 25 mm InPro 6800 DO Sensor Series (T-82 Connector)

Sensor	Length	Connector	Order Number
InPro 6820	80 mm	Straight T-82	52 201 020
InPro 6820	160 mm	Straight T-82	52 201 021
InPro 6820	260 mm	Straight T-82	52 201 022
InPro 6830	80 mm	Angled T-82	52 201 023
InPro 6830	160 mm	Angled T-82	52 201 024
InPro 6830	260 mm	Angled T-82	52 201 025

### InPro 6800/6850 i Consumables

	Order Number
Membrane body, single T-96	52 200 071
Membrane kit T-96 (4 membranes, 1 O-ring set silicone, 25 ml of electrolyte, wetted parts SS 316L)	52 200 024
Membrane bodies (16 pieces), T-96	52 206 114
O <sub>2</sub> electrolyte pack (3 × 25 mL)	30 298 424
InPro 6800 replacement anode/cathode assembly	52 200 899
InPro 6850 i replacement anode/cathode assembly	52 206 347

For accessories refer to page 59, for cables and cable lengths refer to page 146 – 149.

Angled version of InPro 6800



Replaceable anode/cathode assembly



### Did You Know

The dissolved oxygen membrane used on these sensors is more durable and less prone to fouling than competitive products due to its advanced membrane design. This makes these sensors an excellent choice for dirty DO applications.

### Suitable Housings for 12 mm p.

InFit 761 e.....	122
InFit 762 e/763 e.....	124
InFlow .....	128
InDip .....	126
InTrac 777 e.....	133
InTrac 797 e.....	134
InTrac 781 .....	135
InTrac 785/787 .....	136

## InPro 6900 (i)/InPro 6950 i Accurate Trace Oxygen Measurement



Angled version also available

**USP**  
Class VI



**ISM**

InPro 6950 i    InPro 6900

### Features Overview

- Revolutionary “Quick Disconnect” system allows for service in seconds
- Accurate measurement at very low levels of oxygen
- Long lasting and easy to maintain membranes
- FDA positive listed materials of construction
- Hygienically polished surface finish of N5/R<sub>a</sub>16 (R<sub>a</sub>=0.4 μm/16 μin)
- EHEDG certified for cleanability and 3-A compliant
- Wetted O-rings comply with FDA and USP Class VI standards
- Steam sterilizable

▶ [www.mt.com/InPro69x0](http://www.mt.com/InPro69x0)

The InPro 6900 and the InPro 6950 dissolved oxygen sensors with 12 mm diameter body offer the same advanced features as the InPro 6800, with the additional benefit of being able to measure trace oxygen concentrations. In particular, the InPro 6950 i sensor offers excellent accuracy at the lowest oxygen levels due to the built-in 4-electrode measurement system. Ingold’s unique cathode design, membrane and specially formulated electrolyte generate stable and accurate results at extremely low levels of oxygen.

### Specifications

#### Performance

Operating range	<b>InPro 6900 (i):</b> 1 ppb to saturation in aqueous solutions 3 ppb to saturation in CO <sub>2</sub> containing solutions
	<b>InPro 6950 i:</b> 0.1 ppb to saturation in aqueous solutions 0.25 ppb to saturation in CO <sub>2</sub> containing solutions

Accuracy	<b>InPro 6900 (i):</b> ≤ ± [1 % + 1 ppb] / ≤ ± [1 % + 3 ppb]
	<b>InPro 6950 i:</b> ≤ ± [1 % + 0.1 ppb] / ≤ ± [1 % + 0.25 ppb]

Response time at 25 °C (77 °F)	<b>InPro 6900 (i):</b> 98 % of final value in <90 s
	<b>InPro 6950 i:</b> 90 % of final value in <90 s

Sensor signal in air at 25 °C (77 °F)	<b>InPro 6900 (i):</b> 250 to 500 nA
	<b>InPro 6950 i:</b> 2500 to 6000 nA

Residual signal in oxygen-free medium	<b>InPro 6900 (i):</b> <0.03 % of the signal in ambient air
	<b>InPro 6950 i:</b> <0.025 % of the signal in ambient air

#### Construction

Measuring principle	Amperometric Clark electrode
Sensor design	12 mm sensor with VP design
Connector design	Straight or angled
Process connection	Pg 13.5
Sensor body	316L stainless steel
Membrane material	PTFE/Silicone (reinforced)
Surface roughness of wetted parts	N5/R <sub>a</sub> 16 (R <sub>a</sub> =0.4 μm/16 μin)
O-ring material	Silicone (FDA and USP Class VI positive listed)

#### Working Conditions

Temperature compensation	Automatic
Measuring temperature range	0 to 80 °C (32 to 176 °F)
Environmental temperature range	<b>InPro 6900 (i):</b> –5 to 140 °C (23 to 284 °F) (sterilizable and autoclavable)
	<b>InPro 6950 i:</b> –5 to 121 °C (23 to 250 °F) (sterilizable)

Operating pressure	<b>InPro 6900 (i):</b> 0.2 to 6 bar (2.9 to 87 psi absolute) 0.2 to 9 bar (2.9 to 130 psi absolute) with T-6900 R
	<b>InPro 6950 i:</b> 0.2 to 9 bar (2.9 to 130 psi absolute)

Design pressure	Maximum 12 bar (174 psi absolute)
-----------------	-----------------------------------

#### Certificates and Approvals

METTLER TOLEDO Quality Certificate, EHEDG, FDA/USP Class VI, 3.1, N5/Ra16, ATEX: Ex ia IIC T6/T5/T4/T3 Ga/Gb, Ex ia IIIC T69 °C/T81 °C/T109 °C/T161 °C Da/Db FM: IS Cl. I, II, III, Div 1, GR ABCDEFG/T6
--

#### Intelligent Sensor Management (ISM)

Intelligent Sensor Management (ISM) InPro 6900 i and 6950 i sensors with integrated ISM functionality allow Plug and Measure and advanced diagnostics. ISM simplifies the installation, handling and maintenance of measurement equipment. For more information see ISM introduction pages 10–11.





## Ordering Information

### 12 mm InPro 6900 (i) DO Sensor Series

Sensor	Length	Connector Style	VP Order Number	ISM Order Number
InPro 6900 (i)	70 mm	Straight	52 200 944	52 206 316
InPro 6900 (i)	120 mm	Straight	52 200 945	52 206 317
InPro 6900 (i)	220 mm	Straight	52 200 946	52 206 318

### 12 mm InPro 6950 i DO Sensors

Sensor	Length	Connector Style	ISM Order Number
InPro 6950 i	70 mm	Straight	52 206 127
InPro 6950 i	120 mm	Straight	52 206 128
InPro 6950 i	220 mm	Straight	52 206 129
InPro 6950 i	320 mm	Straight	52 206 130

### InPro 6900 (i) Consumables

	Order Number
Membrane body, single InPro 6900 (i)	52 201 049
Membrane kit InPro 6900 (i)	52 201 003
(4 membranes, 1 O-ring set silicone, 10 ml of electrolyte, wetted parts SS 316L)	
Reinforced membrane body, single InPro 6900 (i) (T-6900 R)	52 201 108
Reinforced membrane kit InPro 6900 (i) (T-6900 R)	52 201 109
(4 membranes, 1 O-ring set silicone, 10 ml of electrolyte, wetted parts SS 316L)	
InPro 6900 electrolyte pack (3 × 5 mL)	30 298 425
InPro 6900 (i) replacement anode/cathode assembly	52 200 943

### InPro 6950 (i) Consumables

	Order Number
Membrane kit InPro 6950 i	52 206 106
(4 membranes, 1 O-ring set silicone, 10 ml of electrolyte, wetted parts SS 316L)	
InPro 6950 electrolyte pack (3 × 5 mL)	30 298 426
InPro 6950 i replacement anode/cathode assembly	52 206 112

For accessories and spare parts refer to p. 59.

Replaceable anode/cathode assembly for InPro 6950



Reinforced membrane body InPro 6900

## Other Highlights

- Small 12 mm diameter saves valuable space
- Watertight VP connector (IP68)
- Variety of sensor lengths available
- Withstands CIP

## InPro 6900 (i)/InPro 6950 i Transmitter Compatibility

Sensor	M400 Type 3	M800 2/4-ch	M800 1-ch
InPro 6900	•	–	•
InPro 6900 i	•	•	•
InPro 6950	–	–	•
InPro 6950 i	•	•	•

## Suitable Housings

	p.
InFit 761 e.....	122
InFit 762 e/763 e.....	124
InFlow .....	128
InDip .....	126
InTrac 777 e.....	133
InTrac 797 e.....	134
InTrac 781 .....	135
InTrac 787 .....	136

## InTap: Portable Optical Dissolved Oxygen Analyzer Maximum Control of Beverage Quality



Dissolved oxygen level is an important quality factor in the food and beverage industry. Maintaining low oxygen levels in food and beverage production ensures flavor stability as well as long shelf life. The InTap, with an internal optical DO sensor, allows users to measure dissolved oxygen values wherever and whenever required for optimum control of production processes and product quality.

The InTap is used for the measurement of beverage DO, and at-line measurement of beer during or after filtration and prior to filling. Further, the InTap is the perfect reference measurement instrument for calibrating installed in-line oDO sensors that measure at the lowest oxygen ranges.

The InTap is equipped with a Bluetooth interface and can connect to sensors equipped with the T100 Bluetooth tool.

Reference calibration is done with a few clicks and can be transmitted wirelessly to the sensor. All data is stored in the InTap's USB-connected storage and a database of measurement points is easily built up.

### Specifications

Measurement parameters	DO saturation e.g. concentration and temperature
Operating range*	0 ppb to 2000 ppb
Accuracy*	$\leq \pm [1\% + 2 \text{ ppb}]$
Response time at 25°C (air to N <sub>2</sub> ); † 98%	< 20s
Temperature measuring range	-5 to 60 °C (23 to 140 °F)
Operating pressure range	0 to 6 bar
Design pressure	10 bar
Protection rating	IP 67
Weight	3.5 kg
Battery	up to 24 h
Data storage	8 GB

\*Sensor specifications

### Features Overview

- 4.0" touchscreen
- Fast response time
- Lowest calibration requirement
- Highest accuracy down to 2 ppb
- IP 67 enclosure resists harsh environments

### Other Highlights

- Full user management
- Wireless in-line sensor calibration
- Data logging up to 24 h
- Measurement point data management
- Calibration report management
- ISM predictive maintenance tools

## Ordering Information

<b>Analyzer</b>		<b>Order Number</b>
InTap portable oDO analyzer		30 425 550
InTap portable oDO analyzer imp. inch/US		30 457 912
<b>Accessories</b>		<b>Order Number</b>
T100 M12 Bluetooth Interface for in-line sensor		30 432 819
<b>Replacement Parts</b>		<b>Order Number</b>
InTap 12V Power Supply Set		30 383 009
OptoCap for InTap (OptoCap BR01)		52 206 403
O <sub>2</sub> sensor InTap		30 422 571
Polyamide hose Ø 6×4 mm		30 422 575
Polyamide hose Ø ¼" (2m)		30 461 774



T100: Bluetooth interface for oDO sensors.



Touchscreen interface with convenient data management

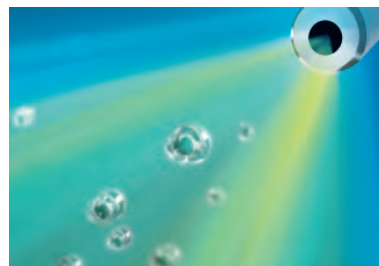

Stable and accurate results with minimized calibrator demands.

Beyond optical technology METTLER TOLEDO has implemented Automatic Stability Control (ASC) to ensure stable and reliable results, also minimizing calibration demands.



With the InTap you can store the calibration data of installed sensors and build up an electronic database for sensor management. Data is stored on a USB stick and can be transferred conveniently to a PC.



**Did You Know**  
Installed oDO sensors can be upgraded with the T100 Bluetooth tool, allowing calibration data to be sent wirelessly to the InTap.

## InPro 6050 Continuous Control of Your Wastewater Application



The InPro 6050 dissolved oxygen sensor provides reliable continuous measurement of dissolved oxygen in water applications including biological treatment in wastewater. The InPro 6050 offers proven Ingold sensor technology with an integrated thermistor in a rugged plastic sensor body providing optimum measurement accuracy at an affordable price. The PTFE/silicone membrane is reinforced by an integral stainless steel mesh, which provides durability and mechanical stability to ensure reliable, continuous on-line measurement.

### Specifications

#### Performance

Operating range	30 ppb to saturation
Accuracy	± [1 % + 30 ppb]
Response time at 25 °C (77 °F)	98 % of final value in < 90 s
Sensor signal in air at 25 °C (77 °F)	40 to 110 nA
Residual signal in oxygen-free medium	< 0.3 % of the signal in ambient air

#### Construction

Measuring principle	Amperometric Clark electrode
Cable connection	VP
Connector design	Straight
Process connection	Pg 13.5
Sensor body	PPS
Membrane material	PTFE/Silicone/PTFE (reinforced w/steel mesh)
O-ring material	Viton®, Silicone
Sensor diameter	12 mm
Shaft length	120 mm

#### Working Conditions

Temperature compensation	Automatic
Measuring temperature range	0 to 60 °C (32 to 140 °F)
Design pressure	Maximum 2 bar (29 psi absolute)

#### Certificates and Approvals

METTLER TOLEDO Quality Certificate

### Features Overview

- Rugged sensor designed for the wastewater industry
- Low maintenance
- Accurate measurement and quick response
- Long lasting and easy to maintain membranes
- Watertight VP connector (IP 68)
- PTFE coated membrane protects the membrane against particle adhesion and chemical interference

### Ordering Information

Sensor	Length	Connector Style	Order Number
InPro 6050	120 mm	Straight VP	52 200 851

### InPro 6050 Consumables

#### Order Number

Membrane body, single T-96	52 200 071
Membrane kit T-96 (4 membranes, 1 O-ring set, 25 ml of electrolyte)	52 200 024
O <sub>2</sub> electrolyte pack (3 × 25 ml)	30 298 424

For accessories and spare parts refer to p. 59.

► [www.mt.com/InPro6050](http://www.mt.com/InPro6050)

# Oxygen Accessories and Spare Parts

## For Efficient Operation



Membrane kit with 4 membranes and electrolyte

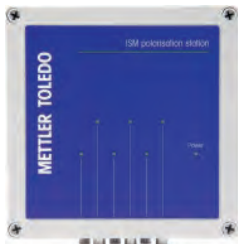

6-port ISM polarization station for digital oxygen sensors



ISM O<sub>2</sub> Verification Kit. See page 116 for details.



ISM Optical O<sub>2</sub> Verification Kit. See page 117 for details.

An oxygen measuring system is made up of several important components and because the measurement is so critical to the process, all of them need to operate efficiently. This section outlines the accessories and maintenance items that can be used to optimize and maintain the quality of measurement.

### Membrane maintenance

Perhaps the most common problem seen over time with electrochemical oxygen sensors is membrane integrity. During the course of a membrane's life it may encounter difficult situations such as harsh samples, multiple sterilization cycles, or impact, all of which cause normal wear and tear on the membrane. Ingold pioneered the design of the PTFE and silicone membrane with a built-in steel mesh that greatly increases membrane durability, extends membrane life and can be easily and quickly replaced as required. We offer multiple membrane styles according to your application including those that have FDA positive listed components for wetted parts.

### Spare Parts – Ordering Information

InPro 6800 and InPro 6000 Series Sensor Membranes	Order Number
Membrane kit, S-96 (silicone)	52 200 025
Membrane kit, T-96 (PTFE)	52 200 024
Membrane body, single, S-96	52 200 072
Membrane body, single, T-96	52 200 071
O <sub>2</sub> electrolyte pack (3 × 25 ml)	30 298 424
Cap sleeve N (no protective cage)	52 200 037
Cap sleeve P (protective cage)	52 200 038
Cap sleeve N, HA-C22	52 200 642

### Accessories – Ordering Information

Product Description	Order Number
Digital ISM sensor master	52 206 329
Digital ISM sensor 6-port polarization station	52 206 480
ISM simulator O <sub>2</sub> Kit for InPro 6850i/6850iG	52 300 416
ISM simulator O <sub>2</sub> ppb Kit for InPro 6900i/6900iG	52 300 422
ISM simulator O <sub>2</sub> Trace Kit for InPro 6950i/6950iG	52 300 428
InPro 6800 sensor master polarization unit	52 200 892
InPro 6900 sensor master polarization unit	52 200 893
InPro 6950 sensor master polarization unit	52 206 113
DO sensor simulator for T-82 cabled transmitters	59 906 816
DO sensor simulator for VP cabled transmitters	52 200 891
Oxygen zeroing gel (3 × 25 mL)	30 300 435
Adapter T-82 cable to VP electrode connector	52 200 939
Adapter VP cable to T-82 electrode connector	52 200 940
Cap sleeve without protective cage N-type (SS 316L)	52 200 037
Cap sleeve with protective cage P-type (SS 316L)	52 200 038
Cap sleeve without protective cage N-type (C22)	52 200 642
Cap sleeve without protective cage N-type (Ti)	52 200 268
Optical O <sub>2</sub> Simulator	30 404 694

## Introduction

Reliable Monitoring and Control of the CO<sub>2</sub> Level

# In Situ Monitoring of Dissolved CO<sub>2</sub> in Bioreactors For Successful Fermentation

### The importance of dissolved carbon dioxide in biotech or pharmaceutical processes

Besides pH and dissolved oxygen measurements, reliable monitoring and control of the CO<sub>2</sub> partial pressure is important for successful fermentation. METTLER TOLEDO Ingold's CO<sub>2</sub> system delivers precise, real-time data that increases understanding of critical fermentation and cell culture processes. This information will help you gain insight into cellular metabolism and other changes within the bioreactor.

A significant trend in biotechnology today is the increasing use of mammalian cell lines including human, monkey, mouse and bovine cells. Various types of bioreactors are now being used to cultivate these animal cells. One of the most important requirements for optimal cell growth in a bioreactor is continuous monitoring and control

of critical parameters, which include O<sub>2</sub>, pH, CO<sub>2</sub> and temperature. Reliable measurement of CO<sub>2</sub> is essential for successful large-scale operation as the accumulation of CO<sub>2</sub> becomes more problematic at high viable cell concentrations. High CO<sub>2</sub> concentrations can inhibit cell growth and product formation in mammalian cells and alter the glycosylation pattern of recombinant proteins. By maintaining low and constant levels of CO<sub>2</sub>, the production rate of pharmaceuticals, proteins and antibodies can be significantly increased.

### Dissolved carbon dioxide sensors

The InPro 5000 i dissolved CO<sub>2</sub> sensor utilizes the Severinghaus principle of CO<sub>2</sub> measurement which was developed in 1958 for use in blood-gas analysis. The sensing electrode in this principle is an enhanced pH electrode separated from the measurement media by an electrolyte-filled gas permeable

membrane. CO<sub>2</sub> diffuses through the membrane and into the inner electrolyte where it equilibrates with bicarbonate ions, altering the pH value. The relative change in pH value of the electrolyte is then measured by the enhanced pH electrode and correlated to CO<sub>2</sub>.

The InPro 5000 i series sensor has been optimized for in situ analysis of dissolved CO<sub>2</sub> in fermentation and cell culture processes. This sensor has a high surface finish for ultimate cleanability and can be steam sterilized or autoclaved. The modular membrane allows for maintenance in seconds and its unique construction stops interference of volatile acids which are often found in bioprocesses.



A perfect team: M400 transmitter with InPro 5000 i CO<sub>2</sub> sensor

Measuring principle of the InPro 5000 i sensor

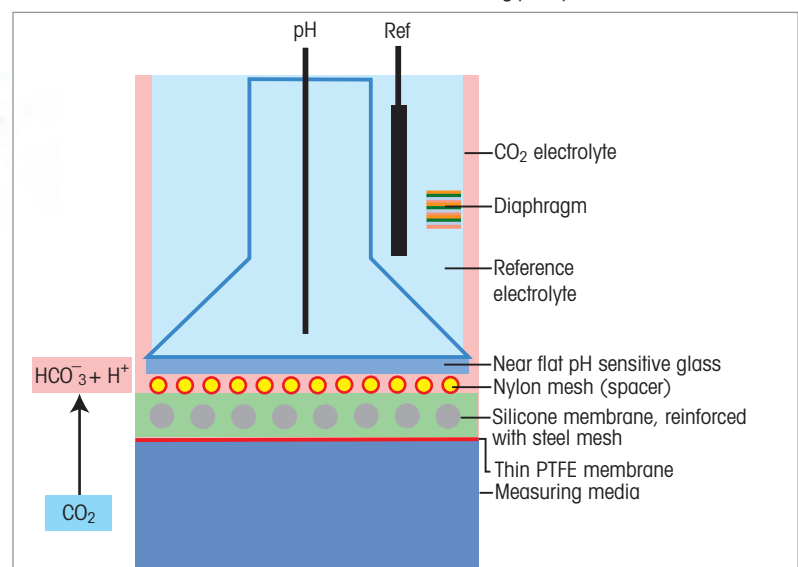

# In-line CO<sub>2</sub> Measurement in Beverages

## Proven Technology, Simplified Operation

**In-line CO<sub>2</sub> measurements in brewery and carbonated soft drinks processes are commonly used to ensure consistent beverage quality. However, initial investment, installation costs, and expenditure caused by unscheduled system downtime can amount to an unfavorable total lifetime cost of measurement equipment. A sensor that offers simplified handling and enhanced diagnostics leads to more reliable and cost effective operation.**

### Importance of CO<sub>2</sub> measurements

For consumers, the mouthfeel (and foam in the case of beer) is as important as a beverage's taste. Monitoring and controlling dissolved CO<sub>2</sub> concentrations helps ensure consumers' experience the sight and effervescence of your products the way you want them to. Consequently, typical applications for in-line CO<sub>2</sub> measurement systems in beverage producing processes are:

- Beverage carbonation control
- Measurements in filling lines
- Monitoring of possible CO<sub>2</sub> losses in critical process steps
- Deaerated water carbonation control

As much as reproducible CO<sub>2</sub> concentrations are responsible for consistent product quality, different packaging solutions also require different CO<sub>2</sub> levels for beverage dispensing and process safety reasons, e.g. to avoid mechanical damage to cans in tunnel pasteurizers due to high CO<sub>2</sub> levels. Table 1 shows typical concentration ranges for different beverages and packages.

### Thermal conductivity plus Intelligent Sensor Management

The InPro 5500i combines enhanced TC measurement with the proprietary Intelligent Sensor Management (ISM) concept. ISM simplifies sensor handling, enhances reliability and reduces sensor lifecycle costs. Plug and Measure installation and predictive maintenance tools, such as an indicator for falling membrane integrity, increases measurement point uptime and improve process safety.

Together with the M400 ISM transmitter operators can take full advantage of features that non-ISM systems cannot match.

Product	Typical CO <sub>2</sub> Concentration
Deaerated water used in blending processes	2 g/L (1 Vol) up to concentration of packaged beverage
Beers filled in cans/kegs	Up to 5.2 g/L (2.6 Vol)
Bottom fermented beers in bottles	5 to 6 g/L (2.5 to 3.0 Vol)
Top fermented beers in bottles	6 to 9 g/L (3 to 4.5 Vol)
Carbonated soft drinks	5 to 10 g/L (2.5 to 5 Vol)

Table 1: Typical CO<sub>2</sub> ranges in carbonated beverages

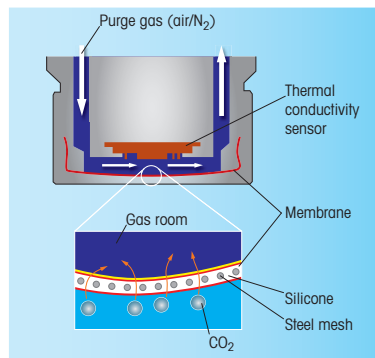

Fig 1: TC sensor design—complete avoidance of moving parts

**ISM**



Fig 2: METTLER TOLEDO's InPro 5500i in-line dissolved CO<sub>2</sub> sensor employs thermal conductivity measurement

## Dissolved Carbon Dioxide Sensors

For High Level Biopharmaceutical Applications

Dissolved Carbon Dioxide

### InPro 5000 i For Accurate CO<sub>2</sub> Measurement



USP  
Class VI

FDA



ISM

The InPro 5000 i dissolved carbon dioxide sensor allows for the accurate measurement and control of dissolved CO<sub>2</sub> in biopharmaceutical applications. The measuring principle is based on the Severinghaus principle of potentiometric CO<sub>2</sub> measurement which has been widely accepted for over 55 years. The high surface finish of the stainless steel sensor prevents contamination and the sensor is fully sterilizable either in-situ or in an autoclave. The design of the membrane dramatically reduces full service time to just minutes. The interior body, a high performance pH electrode, can easily be replaced at your site. No need to send the sensor in for service. Also available with Intelligent Sensor Management (ISM) for Plug and Measure and advanced diagnostics (see pages 10-11).

#### Specifications

##### Performance

Measuring range	10 to 1000 mbar pCO <sub>2</sub>
Accuracy	± 10 % + 2 mbar (pCO <sub>2</sub> 10 to 1000 mbar) ± 5 % (pCO <sub>2</sub> 10 to 300 mbar)*
Response time	90 % of final value < 120 s at 25 °C (77 °F)

##### Construction

Measuring principle	Potentiometric Severinghaus
Cable connection	K8S
Process connection	Pg 13.5
Sensor body	316L stainless steel
Membrane material	Silicone (reinforced with steel mesh)
Surface roughness of wetted parts	N5 (R <sub>a</sub> = 0.4 μm / 16 μin)
O-ring material	Viton®, Silicone (FDA compliant)
Sensor diameter	12 mm

##### Working Conditions

Temperature compensation	Automatic
Temperature sensor	Digital
Measuring temperature range	0 to 60 °C (32 to 140 °F)
Sterilization temperature	135 °C / 275 °F (sterilizable and autoclavable)
Operating pressure	0.2 to 2 bar (3 to 30 psi)
Design pressure	Maximum 3 bar (42 psi) at 25 °C (77 °F)

##### Certificates and Approvals

METTLER TOLEDO Quality Certificate, EHEDG, FDA, USP Class VI, 3.1, N5/R<sub>a</sub>16

\* valid for measurement within ±100 mbar of calibration point (pCO<sub>2</sub> cal point 10 to 300 mbar)

#### Other Highlights

- Small 12 mm diameter saves valuable space
- Pg 13.5 threads for interface into vessels or housing
- Variety of sensor lengths available

#### Features Overview

- Revolutionary design of the sensor allows for full service in seconds
- In situ measurement of CO<sub>2</sub>
- Autoclavable and steam sterilizable
- Accurate measurement and quick response
- Long lasting and easy to maintain membranes

- FDA positive listed materials of construction
- High surface finish of N5 (R<sub>a</sub> = 0.4 μm / 16 μin)
- EHEDG certified for cleanability
- Wetted O-rings comply with FDA and USP VI standards

▶ [www.mt.com/InPro5000](http://www.mt.com/InPro5000)



## Ordering Information

### 12 mm InPro 5000 i CO<sub>2</sub> Sensors

Sensor	Length	Connector Style	Order Number
InPro 5000i	120mm	K8S	30 013 606
InPro 5000i	220mm	K8S	30 019 005
InPro 5000i	320mm	K8S	30 019 006

### Transmitter

Transmitter	Order Number
M100 SM 1-wire	30 365 366
M400 Type 2	30 374 112
M400 Type 3	30 374 113
M400 PA	30 026 617
M400 FF	30 026 616
M400 FF 4-wire	30 374 121
M800 Process, 1-channel	30 026 633
M800 Process, 2-channel	52 121 813
M800 Process, 4-channel	52 121 853
M800 Process 1-channel SST	30 246 551
M800 Process 2-channel SST	30 246 552
M800 Process 4-channel SST	30 246 553

### InPro 5000 i Consumables

InPro 5000 i Consumables	Order Number
InPro 5000i membrane kit (4 membranes, 1 O-ring set, 25 ml of electrolyte)	52 206 055
Interior body InPro 5000i, 120mm	30 019 049
Interior body InPro 5000i, 220mm	30 019 170
Interior body InPro 5000i, 320mm	30 019 175

### InPro 5000 i Accessories

InPro 5000 i Accessories	Order Number
InPro 5000i CO <sub>2</sub> ISM Verification Kit	30 031 035
pH buffer 7.00	51 340 059
pH buffer 9.21	51 300 193
Cap sleeve without protective cage N-type	52 201 153
Cap sleeve with protective cage P-type	52 201 154



The InTrac 797 e can be used to calibrate the InPro 5000 i sensor in pilot and production fermentors, without interrupting the process.



### Did You Know

The InPro 5000 i membrane inhibits the passage of volatile organic acids (a common by-product of biological processes), which would otherwise interfere with CO<sub>2</sub> measurement.

### Suitable Housings

Suitable Housings	p.
InFit 761 e.....	122
InTrac 797 e.....	134
InTrac 781 .....	135

## InPro 5500 i Less Maintenance, Greater Reliability



### Features Overview

- Direct process connections with three choices (Varivent, Tri-Clamp, 28 mm/M42)
- Integrated temperature sensor
- Hygienic design, capable of withstanding CIP procedures
- O-rings with FDA approval
- Stainless steel surface with highly polished finish
- Steam sterilizable up to 120 °C (248 °F)
- Minimal and easiest membrane maintenance

The InPro 5500i thermal conductivity CO<sub>2</sub> sensor provides reliable in-line measurement of dissolved carbon dioxide for a wide spectrum of food and beverage (brewery and carbonated soft drinks) processes. Intelligent Sensor Management (ISM) technology simplifies sensor handling and reduces sensor lifecycle cost. The InPro 5500i thermal conductivity CO<sub>2</sub> sensor offers outstanding features, e.g., direct process connections, and integrated temperature sensor. Its hygienic design is capable of withstanding CIP procedures. Furthermore, the sensor is equipped with ISM technology which provides unique features such as Plug and Measure, automatic sensor protection, and predictive maintenance functions (see pages 10–11).

### Specifications

#### Performance

Measuring range	0 to 10 bar p (CO <sub>2</sub> )/0 to 145 psig p (CO <sub>2</sub> ) 0 to 15 g/L CO <sub>2</sub> , 0 to 7 V/V CO <sub>2</sub>
Accuracy in fluids	± 1 % within ± 5 % °C of calibration temperature ± 2 % over temperature range 0 to 50 °C (32 to 122 °F)
Cycle time	< 20 s
Flow requirements	min. 0.5 m/s

#### Construction

Measuring principle	Thermal conductivity
Cable connection (digital)	5-pin, RS485 data cable
Process connections	Varivent Type N, Tri-Clamp 2", 28 mm with cap nut M42
Sensor body (wetted parts)	316 L stainless steel
CO <sub>2</sub> selective membrane material	PTFE/Silicone (reinforced with steel mesh)
Surface roughness of wetted parts	N5 (R <sub>a</sub> = 0.4 μm/16 μin)
O-ring material	EPDM (wetted parts), other material on request
Protection class	IP 67

#### Working Conditions

Operating pressure	0 to 20 bar absolute/0 to 290 psi
Design pressure	= permissible pressure range
Permissible temperature range*	0 to 50 °C (32 to 122 °F)
Operating temperature range	– 5 to 121 °C (23 to 250 °F)
Sterilization temperature	up to 120 °C (248 °F)

#### Certificates and Approvals

MaxCert certification package (Material Certificate 3.1, Surface Finish Certificate 2.1, Final Inspection Certificate)

### Other Highlights

- Wide CO<sub>2</sub> detection range – 0 to 15 g/L CO<sub>2</sub>
- Improved thermal conductivity technique for greater accuracy and low drift
- Immunity to background gases results in high CO<sub>2</sub> selectivity
- Predictive maintenance tools such as Dynamic Lifetime Indicator (detects when membrane replacement will be required) and Adaptive Calibration Timer (predicts when calibration should be performed)

► [www.mt.com/InPro5500i](http://www.mt.com/InPro5500i)

**Ordering Information****InPro 5500 i Thermal Conductivity CO<sub>2</sub> Sensors**

Sensor	Order Number
InPro 5500i/Varivent Type N	30 034 265
InPro 5500i/Tri-Clamp 2"	30 034 266
InPro 5500i/28 mm/M42	30 034 264

**Accessories**

Accessories	Order Number
CalBox	52 300 400
Purge gas conditioner	30 034 319

**Cables**

Cables	Order Number
<b>– Data cable (5-pin) for InPro 5500 i temperature range –30 to 80 °C (–22 to 176 °F)</b>	
RS485/2 m (6.6 ft)	52 300 379
RS485/5 m (16.4 ft)	52 300 380
RS485/10 m (32.8 ft)	52 300 381
RS485/15 m (49.2 ft)	52 206 422
RS485/25 m (82.0 ft)	52 206 529

**Spare Parts**

Spare Parts	Order Number
MembraCap	30 034 318

**Transmitters**

Transmitters	Order Number
M400 Type 3	30 374 113
M400/2H	30 025 514
M400/2(X)H	30 025 515
M400 FF	30 026 616
M400 PA	30 026 617
M800 SST, 1-channel	30 246 551
M800 SST, 2-channel	30 246 552
M800 Process, 1-channel	30 026 633
M800 Process, 2-channel	52 121 813
M800 Process, 4-channel	52 121 853

**Process connection compatibility**

Varivent, Tri-Clamp and 28 mm/M42 process connections, plus the integrated temperature sensor for more accurate CO<sub>2</sub> measurement, means commissioning is quick and straightforward. The hygienic membrane cap has been designed for ease of cleanability and simple, quick exchange.

**Did You Know**

The InPro 5500 i can be combined with an M400 for a single loop or with an O<sub>2</sub> sensor using the M800 multi-channel transmitter for a complete dual O<sub>2</sub>/CO<sub>2</sub> loop.



# Versatile Turbidity Measurement For Multiple Industries and Applications

**Turbidity measurements are important indicators in many processes as they not only influence the yield of your process but also detect factors which are detrimental to a system.**

### **Backscattered light technology**

With a single optical fiber turbidity sensor, the emitted and backscattered light travels on the same fiber. Linear measurement for medium to high levels of turbidity is possible. With a system of two optical fibers the emitted and backscattered light travels on two fibers. Sensitivity to detect particles is consequently higher.

### **Forward scattered light technology**

This technology provides an optimum measuring range for low to medium turbidity levels. They are ideal for detection of larger particles  $>0.3\mu\text{m}$  and with the simultaneous measurement of forward and direct light allows for compensation of color.

### **Turbidity and color monitoring**

The sophisticated digital measuring technology in the InPro 86X0ie sensor is based on the photometric determination of blue and red light. Whereas the blue light is used to detect the color of the medium, in particular the color of beer, the scattering of red light is used to simultaneously detect the turbidity of the medium.

### **New optical product monitor**

Precise monitoring of phase separation in food and beverage production is easily achieved by applying our InPro 8300 RAMS optical product monitor. Up to eight signals from long-life LEDs allow automated in-line product characterization by turbidity and color, as well as identifying products by their optical "fingerprint".

### **Turbidity sensor selection**

METTLER TOLEDO Ingold offers several types of turbidity sensors that are optimized for specific measurement ranges and different applications. Depending on the applied technology and design they can be used in many industries such as:

- Biotechnology
- Pharmaceutical
- Chemical Processing
- Petrochemical
- Food and Beverage
- Breweries

Sensor versatility matches the requirements of diverse applications in which they can be implemented:

- Fermentation
- Biomass growth (cell density)
- Crystallization
- Phase separation
- Water in oil
- Filter breakthrough
- Activated sludge
- Post filtration of beer
- Wastewater

**Our versatile turbidity measurement systems can be implemented in practically any process.**

**Application guide for turbidity systems**

	Low and medium turbidity InPro 86X0i e Series	Medium to high turbidity InPro 8050	InPro 8100	InPro 8200iS(H) Epoxy	InPro 8200iS (Kaltrez®)	InPro 8300 RAMS
<b>Industrial processes</b>						
<b>Pharmaceutical Industry</b>						
Biotechnical applications			•		•	
ChemPharma				•		
<b>Chemical Industry</b>				•		
<b>Beverage Industry</b>	•				•	•
<b>Wastewater applications</b>		•		•		
	25° and 90° scattered light	Backscattered light, 1-fiber	Backscattered light, 2-fibers	In-line product monitor		

**Transmitter selection**

For use with the InPro 86X0i e series, the traffic light color-coded touchscreen on the M800 Process transmitter allows operators to evaluate the sensor and process condition at a glance. The M800 transmitter also provides excellent security (setting can be password protected) and convenient operation.

**Color measurement**

Two precision instruments for turbidity and color in-line measurement are combined into one unique sensor. Our food and beverage industry proven InPro 86X0i e incorporates a two-angle turbidity instrument with an EBC color

monitor. Providing two sensors in one maintenance-free instrument means cost of ownership is at a minimum while reliability and easy handling are maximized.

**Turbidity housing selection**

Housing options are available for simple interface into a process. These housings help maintain low maintenance and minimum downtime of your process by allowing easy removal of the turbidity sensor. The housings are designed for strict Clean in Place (CIP) applications and harsh environments.



InPro 8050



InPro 8100



InPro 8200



InPro 8610i e / InPro 8630i e

Our range of turbidity sensors

# Turbidity Sensors

Durable Sensors for Precise Turbidity Control

Turbidity/Optical Density

## InPro 8050/InPro 8100 (Single Fiber) Wide Measurement Range



InPro 8100

InPro 8050

Single optical fiber: emitted and back-scattered light travel on same fiber.

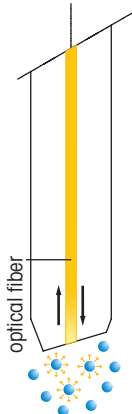

The InPro 8100 and 8050 single optical fiber turbidity sensors are designed for samples that have high particle concentrations and they offer a wide linear measuring range. The InPro 8100 is available in stainless steel and is intended for use in cell culture monitoring, pharmaceutical production, and industrial processes. The InPro 8050 utilizes a rugged polysulfone body and was developed specifically for accuracy and durability in the industrial wastewater environment.

### Specifications

#### InPro 8050

Technology	1 – fiber
Measuring range	10 to 4000 FTU 0 to 250 g/L (diatomaceous earth as reference)
Shaft material	PSU (Polysulfone)
Shaft lengths	120 mm
Sensor diameter	12 mm
Fiber optic cable	6 m (19.7 ft), fixed
Sterilizable	No
Autoclavable	No
Explosion protection	No

#### InPro 8100

Technology	1 – fiber
Measuring range	10 to 4000 FTU 0 to 250 g/L (diatomaceous earth as reference)
Shaft material	Stainless steel (316L)
Shaft lengths	120, 205, 297 or 407 mm
Sensor diameter	12 mm
Surface finish	N5 (R <sub>a</sub> = 0.4 μm / 16 μin)
Fiber optic cable	3 m (9.8 ft), fixed
Sterilizable	Yes, steam sterilizable at 130 °C (266 °F)
Autoclavable	Yes, for autoclavable version see ordering information next page

**Certificates and Approvals** ATEX, CE and Material certificate according to 3.1

### Features Overview

- Backscattered light technology
- Uniform sensor structure reduces fouling and maintenance
- Wide measuring range
- Broad range of applications
- High accuracy

### Other Highlights

- Small 12 mm diameter saves valuable space
- Pg 13.5 threads for interface into housings
- Integrated fiber optic cable
- Variety of sensor lengths available

▶ [www.mt.com/InPro8100](http://www.mt.com/InPro8100)  
▶ [www.mt.com/InPro8050](http://www.mt.com/InPro8050)

**Ordering Information**

<b>InPro 8050</b>	<b>Length</b>	<b>Shaft Material</b>	<b>Order Number</b>
InPro 8050	120 mm	PSU	52 800 209

<b>InPro 8100</b>	<b>Length</b>	<b>Shaft Material</b>	<b>Order Number</b>
InPro 8100	120 mm	Stainless steel	52 800 205
InPro 8100	205 mm	Stainless steel	52 800 206
InPro 8100	297 mm	Stainless steel	52 800 207
InPro 8100	407 mm	Stainless steel	52 800 208
InPro 8100 autoclavable sensor	120 mm	Stainless steel	contact METTLER TOLEDO
InPro 8100 autoclavable sensor	205 mm	Stainless steel	contact METTLER TOLEDO
InPro 8100 autoclavable sensor	297 mm	Stainless steel	contact METTLER TOLEDO
InPro 8100 autoclavable sensor	407 mm	Stainless steel	contact METTLER TOLEDO

**Accessories**

	<b>Order Number</b>
CaliCap calibration accessory	52 800 210
Fiber cable extension kit 3 m (9.8 ft)	52 800 228
Fiber cable extension kit 5 m (16.4 ft)	52 800 229
Fiber cable extension kit 6 m (19.7 ft)	52 800 230
Fiber cable extension kit 10 m (32.8 ft)	52 800 231
Fiber cable extension kit 15 m (49.2 ft)	52 800 232
Fiber cable extension kit 20 m (65.6 ft)	52 800 233
Fiber cable extension kit 25 m (82.0 ft)	52 800 234
Fiber cable extension kit 30 m (98.4 ft)	52 800 235
Couplings to link fiber cables (two included in every kit)	52 800 240
Coupling box IP65 (NEMA 4X)	52 800 241
Swagelok™ adapter NPT 1/2"	52 800 242

Longer cable lengths are available. Please contact METTLER TOLEDO Ingold for details.

**Transmitter**

	<b>Order Number</b>
M800 Process 1-channel	30 026 633



Fiber optic extension cable

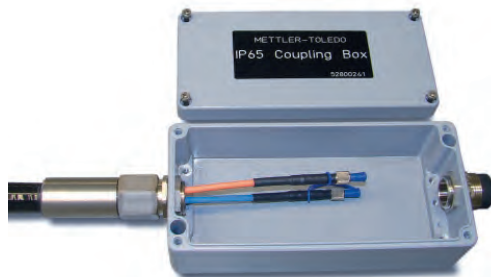

Coupling box for fiber optic cable

M800 1-channel transmitter



**Suitable Housings**

	<b>p.</b>
InFit 761 e.....	122
InFit 762 e/763 e.....	124
InFlow .....	128
InDip .....	126
InTrac 779 e.....	133
InTrac 799 e.....	134
InTrac 785 .....	136

## Turbidity Sensors

Durable Sensors for Precise Turbidity Control

Turbidity/Optical Density

### InPro 8200 (Dual Fiber) High Resolution at Medium Turbidity



Two optical fibers:  
for emitted and  
backscattered  
light protected by  
scratch resistant  
sapphire window.

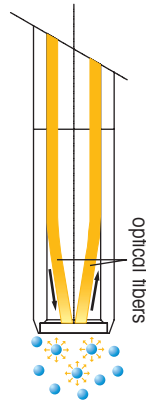

The InPro 8200 dual optical fiber turbidity sensor is designed for samples with medium to high concentration and where high resolution is a requirement. The InPro 8200 is available in stainless steel or Hastelloy™ and is intended for use in cell culture monitoring, crystallization control, and industrial processes including liquid/solid separation.

#### Specifications

Technology	2-fiber
Measuring range	5 to 4000 FTU 0 to 30 g/L (diatomaceous earth as reference)
Shaft material	Stainless steel (316L) Hastelloy
Shaft lengths	120, 205, 297 or 407 mm
Sensor diameter	12 mm
Surface finish	N5 ( $R_a = 0.4 \mu\text{m} / 16 \mu\text{in}$ )
Fiber optic cable	3 m (9.8 ft), fixed
Sterilizable	Yes, steam sterilizable at 130 °C (266 °F)
Autoclavable	No
<b>Certificates and Approvals</b>	ATEX, CE and Material certificate according to 3.1

#### Features Overview

- Backscattered light technology
- Uniform sensor structure reduces fouling and maintenance
- Wide measuring range
- Broad range of applications
- High accuracy
- Sapphire window

#### Other Highlights

- Small 12 mm diameter saves valuable space
- Pg 13.5 threads for interface into housings
- Integrated 3 m (9.8 ft) fiber optic cable
- Variety of sensor lengths available

► [www.mt.com/InPro8200](http://www.mt.com/InPro8200)



### Ordering Information

Sensor	Length	Shaft Material, Window Seal	Order Number
InPro 8200	120 mm	Stainless steel, Epoxy	52 800 216
InPro 8200	205 mm	Stainless steel, Epoxy	52 800 217
InPro 8200	297 mm	Stainless steel, Epoxy	52 800 218
InPro 8200	407 mm	Stainless steel, Epoxy	52 800 219
InPro 8200	120 mm	Hastelloy, Epoxy	52 800 220
InPro 8200	205 mm	Hastelloy, Epoxy	52 800 221
InPro 8200	297 mm	Hastelloy, Epoxy	52 800 222
InPro 8200	407 mm	Hastelloy, Epoxy	52 800 223
InPro 8200/S/Kalrez®-FDA/120	120 mm	Stainless steel, Kalrez®-FDA	52 800 224
InPro 8200/S/Kalrez®-FDA/205	205 mm	Stainless steel, Kalrez®-FDA	52 800 225
InPro 8200/S/Kalrez®-FDA/297	297 mm	Stainless steel, Kalrez®-FDA	52 800 226
InPro 8200/S/Kalrez®-FDA/407	407 mm	Stainless steel, Kalrez®-FDA	52 800 227
InPro 8200/H/Kalrez®-FDA/120	120 mm	Hastelloy, Kalrez®-FDA	Contact METTLER TOLEDO
InPro 8200/H/Kalrez®-FDA/205	205 mm	Hastelloy, Kalrez®-FDA	52 800 264
InPro 8200/H/Kalrez®-FDA/297	297 mm	Hastelloy, Kalrez®-FDA	Contact METTLER TOLEDO
InPro 8200/H/Kalrez®-FDA/407	407 mm	Hastelloy, Kalrez®-FDA	52 800 215

Accessories	Order Number
CaliCap calibration accessory	52 800 210
Fiber cable extension kit 3 m (9.8 ft)	52 800 228
Fiber cable extension kit 5 m (16.4 ft)	52 800 229
Fiber cable extension kit 6 m (19.7 ft)	52 800 230
Fiber cable extension kit 10 m (32.8 ft)	52 800 231
Fiber cable extension kit 15 m (49.2 ft)	52 800 232
Fiber cable extension kit 20 m (65.6 ft)	52 800 233
Fiber cable extension kit 25 m (82.0 ft)	52 800 234
Fiber cable extension kit 30 m (98.4 ft)	52 800 235
Couplings to link fiber cables (two included in every kit)	52 800 240
Coupling box IP65 (NEMA 4X)	52 800 241
Swagelok adapter NPT ½"	52 800 242

Longer cable lengths are available. Please contact METTLER TOLEDO Ingold for details.

Transmitter	Order Number
M800 Process 1-channel	30 026 633



#### Did You Know

The CaliCap calibration accessory can serve two important functions. Firstly, it can be used as a “dry check” to verify the performance of the Transmitter/Sensor combination. Secondly, it provides stable measurement during off-line calibration in small vessels where reflection can disturb the measurement.



Suitable Housings	p.
InFit 761 e.....	122
InFit 762 e/763 e.....	124
InFlow .....	128
InDip .....	126
InTrac 779 e.....	133
InTrac 799 e.....	134
InTrac 785 .....	136

## InPro 8610ie/InPro 8630ie Turbidity Sensor

### Reliable Measurement for Tight Process Control



#### Features Overview

- Real-time window fouling surveillance
- Plug and Measure startup
- ISM provides real-time information on sensor condition
- Automatic color or turbidity compensation

#### Other Highlights

- Compliance with international standards
- Hygienic design
- 12-point turbidity and 6-point color factory pre-calibration over the entire measuring range

The innovative InPro 8610ie and InPro 8630ie turbidity sensors combine precision technology with advanced measurement electronics in one compact sensor head, and provide highly reliable measurements at a reduced installation cost. The forward and 25° sideward scattered light measurement technology in the InPro 8610ie and InPro 8630ie are designed to provide dependable turbidity measurements in the low to medium particle concentration range. Additionally, the InPro 8630ie sensor includes 90° scattered light measurement and a blue LED light source. The 90° scattered light is very sensitive to measuring turbidity in liquids with small undissolved particles such as beer proteins and glucanes. While the blue LED enables color measurement, which is especially useful in beer and sugar processing applications.

#### Specifications

Measuring principle	Turbidity: Scattered light (25°/90°**) Color**: Absorption measurement
Light source	Turbidity: 650nm, LED Color: 430nm, LED
Measuring range	0 to 1000 EBC 0 to 4000 FTU 0 to 50 EBC Color
Units	FTU, NTU, EBC, ASBC, mg/l, ppm, %T
Resolution	0.001 EBC
Process connection	Tuchenhagen-VARINLINE™ Type N50/40
Wetted materials	Hastelloy C22, sapphire windows
Surface finish	N6/Ra 32 (Ra ≤ 0.8 μm/32 μin)
Process temperature	-10 °C to +120 °C (14 to 248 °F) (max. +150 °C peak for 15 mins during SIP/CIP cleaning)
Process pressure	up to 16 bar (232 psi)
Communication	Digital (RS485)
Power supply	24 VDC (±15%), 1.5 W, supply by transmitter
Certificate and Approvals	METTLER TOLEDO Quality Certificate, CE, PED, EHEDG, EC 1935/2004 compliant

\*\* InPro 8630ie only

### Ordering Information

Sensor	Order Number
InPro 8610ie	30 541 120
InPro 8630ie	30 541 121

Transmitter	Order Number
M800 Process 1-channel	30 026 633
M800 Process 1-channel EIP	30 530 023
M800 Process 2-channel EIP	30 530 024
M800 Process 1-channel Profinet	30 530 021
M800 Process 2-channel Profinet	30 530 022

Cables	Order Number
2 m (6.6 ft)	52 300 379
5 m (16.4 ft)	52 300 380
10 m (32.8 ft)	52 300 381
15 m (49.2 ft)	52 206 422

Accessories	Order Number
Verification Kit for InPro 86X0ie	30 562 310

### Process Connection

InPro 86X0ie series sensors are hygienically designed to be installed with a Tuchenhagen-VARINLINE™ access unit type N. The VARINLINE access unit provides maximum cleanliness through zero deadleg design. Standard fittings are provided with butt weld pipe ends but may also be configured with sanitary, male or female NPT or ANSI flanged end connections.

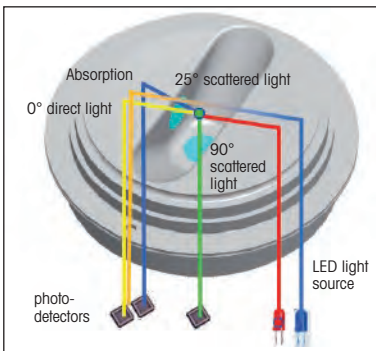

25°/90° scattered light from InPro 8630ie

Forward/90° scattered light sensors: Ratio measurement for color compensation

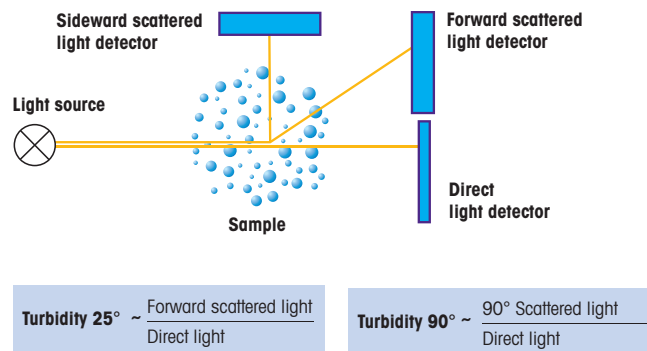

## InPro 8300 RAMS Series Optical Product Monitoring and Identification Systems



### Features Overview

- Monitoring of turbidity and color using one single unit
- Use of durable and long-lasting LEDs
- Excellent zero stability
- Configuration using a PC or notebook
- Easy to retrofit to VARINLINE access units or VARINLINE sight glasses without the need of welding
- In parallel to processing the switching outputs and the analog output in the PLC, visualization via a separate PC is possible

The InPro 8300 RAMS is an optical multi-switch for monitoring product/water phase separation processes and for the identification of products in the process. In process automation applications, the unit supplies the switching signal for product/water or product/product phase separation. Where a range of products is manufactured, it allows unique identification of the different products. Using up to four different wavelengths, the transmitted light and the back-scattered light are measured. This method allows virtually all liquids to be monitored, independently of their color and turbidity.

### Specifications

<b>Main Module</b>		
Measuring cycle (all 8 parameters)		approx. 5 measurements per second
Reaction time		≤ 1 s
<b>Measuring range</b>	TCS	0...100% Absorption turbidity or color system
	BASIC	0...100% Absorption and/or reflection at four wavelengths for product identification
	CAL/COMBINE	Turbidity 0...50/100/200/500/1000 EBC (factory calibrated) Color 0...15/30/60/150 EBC (factory calibrated)
Repeatability		± 1 % of measuring range
Power supply		24VDC ± 5 %
Power consumption		< 50 mA plus total of output currents, polarity reversal protection up to 30 V
Output signal		4...20 mA Calibrated Range or 0...100% Abs./refl.
Configuration interface		RS 232
<b>Operating conditions</b>		
Ambient temperature		0 to 40 °C (32 to 104 °F)
Product temperature		0 to 105 °C (32 to 221 °F) (140 °C/284 °F optional)
Rel. humidity		0 to 100 %
Protection class		IP 67
<b>Materials</b>		
Housing		1.4404
Seals		EPDM/optional Viton®
Viewing window		PVC
Cable glands		brass/nickel plated
<b>OPL-Bits</b>		
Housing material		1.4404
Sealing material		EPDM, optional Viton®
Window material		Borosilicate, sapphire (optional)
Operating pressure		max. 10 bar
Mechanical temp. resistance		- 5 to + 180 °C (23 to 356 °F) (depending on the sealing material)

► [www.mt.com/InPro8300](http://www.mt.com/InPro8300)

**Ordering Information**

Accessories InPro 8300 RAMS	Order Number
OPL bit 0 mm borosilicate window	52 801 153
OPL bit 8 *mm borosilicate window	52 801 124
OPL bit 19 *mm borosilicate window	52 801 125
OPL bit 22 *mm borosilicate window	52 801 126
OPL bit 37 *mm borosilicate window	52 801 127
OPL bit 42 *mm borosilicate window	52 801 128
OPL bit 47 *mm borosilicate window	52 801 129
OPL bit 58 *mm borosilicate window	52 801 130
O-ring set for active and passive part 34.59 x 2.62 mm, EPDM	52 801 150
O-ring set for OPL-Bits, EPDM (FDA)	52 801 151
Desiccant	52 801 134

\* Optional available with sapphire window.

**Configurator InPro 8300 RAMS**

<b>16-17 Type</b>											
BA BASIC											
TC TCS (Turbidity or Color System)											
CA CALI											
CO COMBINE											
<b>19 Temperature</b>											
S Standard											
H High Temperature											
<b>21-22 OPL-bit 1 for detector side</b>											
00 (0 mm/0°)											
08 (8 mm/0.315°)											
19 (19 mm/0.748°)											
22 (22 mm/0.866°)											
37 (37 mm/1.457°)											
42 (42 mm/1.654°)											
47 (47 mm/1.850°)											
58 (58 mm/2.283°)											
<b>24-25 OPL-bit 2</b>											
00 (0 mm/0°)											
08 (8 mm/0.315°)											
19 (19 mm/0.748°)											
22 (22 mm/0.866°)											
37 (37 mm/1.457°)											
42 (42 mm/1.654°)											
47 (47 mm/1.850°)											
58 (58 mm/2.283°)											
<b>27 Window</b>											
B Borosilicate											
S Sapphire											
<b>29-31 Diameter</b>											
25 DN 25											
40 DN 40											
50 DN 50											
65 DN 65											
80 DN 80											
100 DN 100											
150 DN 150											
<b>33 Measurement</b>											
T Turbidity											
C Color											
<b>Calibration 1</b>			<b>Calibration 2</b>			<b>Calibration 3</b>					
min	max		min	max		min	max				
<b>Ordering Code:</b>											
InPro 8300 RAMS/											
1-15	16-17	18	19	20	21-22	23	24-25	26	27	28	

InPro 8300 RAMS



InPro 8300 RAMS software "CONFI"

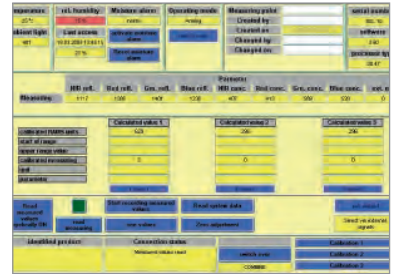

**Other Highlights**

- A PC can be connected to record measured data (min. 3s increments)
- Product identification can be displayed in table or chart form
- Easy copying of data into Excel™
- Automatic self-monitoring of condensation forming on the optical windows
- Sapphire windows available as an option
- High-temperature version available as an option

# Conductivity/Resistivity Systems

## When Optimal Performance Is Essential

**Electrolytic conductivity is a widely used analytical parameter for water purity analysis, monitoring of reverse osmosis, cleaning procedures, control of chemical processes, and in industrial wastewater.**

### Three commonly used techniques

Electrolytic conductivity is a measure of the total ionic content of a solution. There are three main methodologies to measure conductivity:

- 2-electrode sensors are for measurements in high purity water and relatively low conductivity ranges
- 4-electrode sensors are for mid to high ranges. They are more resistant to fouling than 2-electrode designs
- Inductive sensors cover mid to very high conductivity ranges, and are particularly resistant to fouling.

METTLER TOLEDO offers all three methodologies.

### 2-electrode sensor design

An AC voltage is applied across the two electrodes, and the resistance between them is measured. The built-in temperature sensor provides fast accurate measurement. The cell geometry and the high solution resistance allow for very accurate and precise conductivity determination.

Sensors are used for: water conditioning and purification stages where they are capable of detecting minute levels of impurities in ultrapure water.

### 4-electrode sensor design

An AC voltage is applied across the two outside electrodes. The principle is to measure the voltage drop across the two inner electrodes. This eliminates polarization errors. Since this technique measures potential drop the measurement remains accurate.

It permits easier in-line cleaning and it can be installed in smaller piping than inductive sensors.

Sensors are used for: concentration measurement of acids, alkalis, and salt process streams.

### Inductive sensor design

The inductive or “electrodeless” conductivity sensor consists of two toroidal coils encapsulated in an inert polymer body. When placed in a conductive solution, a current loop is generated proportional to the conductivity of the solution.

They are ideal for very high conductivity measurements as found in chemical processes, and aggressive applications where contacting electrodes may not be suitable.

### Continuous conductivity monitoring according to USP <645>

USP guideline <645> sets a standard for the quality assessment of USP waters based on measurement of the electrolytic conductivity. There is a 3-stage test in which stage 1 allows on-line, non-temperature compensated conductivity measurement. There are specific requirements for the sensors and transmitters (see table).

## Application guide for conductivity sensors

Where to use	Ingold sensors										
	InPro 7000-VP	InPro 7001-VP	InPro 7002-TC-VP	InPro 7005-VP	InPro 7108-25-VP	InPro 7108-TC-VP	InPro 7108-VP/CPVC	InPro 7108-VP/PEEK	InPro 7100/InPro 7100i	InPro 7250HT PEEK & PFA	InPro 7250ST PEEK
Pure and ultrapure water	•	•									
Sanitary			•								
Water purification				•				•			
SIP					•	•					
Industrial wastewater						•			•	•	
Medium/high conductivity							•	•	•		
Aggressive chemicals								•	•		
Chemical applications								•	•	•	
Pharmaceutical water								•			
High conductivity									•		
Chemical concentration									•		

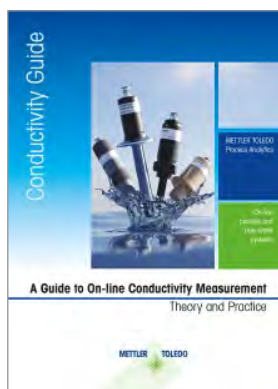

Find out more in our comprehensive conductivity theory guide at [www.mt.com/conductivity-guide](http://www.mt.com/conductivity-guide)

Specification	USP <645>
Conductivity sensor and cell constant accuracy	Verify cell constant within $\pm 2\%$ using a reference solution
Conductivity meter calibration	NIST traceable 0.1% precision resistors in place of sensor
Instrument resolution	0.1 $\mu\text{S}/\text{cm}$
Instrument accuracy at 1.3 $\mu\text{S}/\text{cm}$	0.1 $\mu\text{S}/\text{cm}$
Temperature compensation	Must be read uncompensated
Instrument dynamic range	$10^2$

METTLER TOLEDO instruments meet USP <645> water conductivity requirements.



InPro 7250 HT



InPro 7108-VP/PEEK



InPro 7005-VP



InPro 7002-TC-VP



InPro 7100i

## InPro 7000-VP 2-Electrode Design



InPro 7000-VP



InPro 7005-VP



InPro 7002-VP



InPro 7001-VP



The InPro 7000-VP series are 2-electrode conductivity sensors designed for high accuracy measurements in very low to medium conductivity water. The sensors are available in a wide selection of process connections to meet every application need. Series includes hygienic and sterilizable designs.

### Ordering Information

InPro 7000-VP Series 2-Electrode Sensors	Order Number
InPro 7000-VP	52 001 995
InPro 7005-VP	52 001 996
InPro 7001/120-VP 3.1	52 001 997
InPro 7001/225-VP 3.1	52 001 998
InPro 7002/1.5" TC-VP 3.1	52 001 999
InPro 7002/2" TC-VP 3.1	52 002 000
InPro 7002-VAR-VP 3.1	52 002 857

### Cables

Cables	Order Number
1.5m (4.9ft)	58 080 201
3.0m (9.8ft)	58 080 202
4.5m (14.8ft)	58 080 203
7.5m (24.6ft)	58 080 204
15.0m (49.2ft)	58 080 205
25.0m (82.0ft)	58 080 206
30.0m (98.4ft)	58 080 207
Adapter (VP to old patch cord, 1 m/3.3ft)	58 080 101

### Features Overview

- Watertight VarioPin connector (IP68) for easy connection and excellent signal transmission
- MaxCert certification package includes NIST/ASTM traceable cell constant, 3.1 materials certificate, and FDA compliant materials documentation

### Typical Applications

- Water conditioning and preparation in the chemical, pharmaceutical and food and beverage industries

► [www.mt.com/InPro7000](http://www.mt.com/InPro7000)



## Specifications

	InPro 7000-VP	InPro 7005-VP	InPro 7001-VP	InPro 7002-VP
Measurement principle	2-electrode sensor	2-electrode sensor	2-electrode sensor	2-electrode sensor
Electrode material	Titanium	Titanium	SS 316L	SS 316L
Body material	PVDF	PTFE-coated. SS 316/1.4401	SS 316L	SS 316L
RTD	Built-in Pt 1000	Built-in Pt 1000	Built-in Pt 1000	Built-in Pt 1000
Insertion length	29 mm (1.15")	34 mm (1.35")	120/225 mm (4.71/8.86")	85/104 mm (3.35/4.09")
Max. sensor length	153.20 mm (6.03")	75 mm (2.95")	194/299 mm (7.64/11.77")	156/175 mm (6.14/6.88")
Process connection	¾" NPT 1" NPT conduit	¾" NPT	Pg 13.5	Tri-Clamp 1.5" Tri-Clamp 2" Tuchenhagen- VARIVENT DN 40–DN125
Measuring range	See separate table below			
Cell constant nominal	0.1 cm <sup>-1</sup>	0.1 cm <sup>-1</sup>	0.1 cm <sup>-1</sup>	0.1 cm <sup>-1</sup>
Cell constant accuracy	±1.0%	±1.0%	±1.0%	±1.0%
<b>Working Conditions</b>				
Max. pressure at 25 °C (77 °F)	34 bar (493 psig)	17 bar (246 psig)	17 bar (246 psig)	31 bar (449.5 psig)
Max. pressure at 95 °C (203 °F)	7 bar (100 psig)	7 bar (100 psig)	7 bar (100 psig)	10 bar (145 psig)
Measuring temperature range	-10...100 °C (14...212 °F)	-10...100 °C (14...212 °F)	-10...100 °C (14...212 °F)	-10...120 °C (14...248 °F)
Temperature range (sterilization)	N/A	N/A	Sterilizable -10...131 °C (14...268 °F)	Sterilizable -10...155 °C (14...311 °F)
Temperature accuracy at 25 °C (77 °F)	±0.25 °C (±0.5 °F)	±0.25 °C (±0.5 °F)	±0.25 °C (±0.5 °F)	±0.25 °C (±0.5 °F)
<b>Design</b>				
Temperature compensation	Pt 1000 IEC class A	Pt 1000 IEC class A	Pt 1000 IEC class A	Pt 1000 IEC class A
Cable connection	Vario Pin (IP68)	Vario Pin (IP68) <sup>a</sup>	Vario Pin (IP68)	Vario Pin (IP68)
Wetted parts:				
- Metals	Titanium (Grade 2)	Titanium (Grade 2)	SS 316L	SS 316L
- Plastics	PVDF (FDA)	PTFE-coated. SS 316/1.4401		
- O-rings	Viton® (FDA)	Viton® (FDA)	Viton® (FDA)	Viton® (FDA)
- Insulation	PEEK (FDA)	PEEK (FDA)	PEEK (FDA)	PEEK (FDA)
- Surface roughness of wetted metal parts <sup>b</sup>	N/A	N/A	Polished N4 (R <sub>a</sub> < 0.2 μm) (R <sub>a</sub> < 8 μin)	Electropolished N4 (R <sub>a</sub> < 0.2 μm) (R <sub>a</sub> < 8 μin)
<b>Certificates and Approvals</b>				
Cell constant	•	•	•	•
CE certificate	•	•	•	•
Material certificate EN 10204 3.1	-	-	•	•
Material confirmation EN 10204 2.1	•	•	•	•
Surface roughness	-	-	•	•
ATEX (II 1/2G Ex ia)	•	•	•	•

<sup>a</sup> The VP is at the end of an approx. 0.5 m (1.64 ft) long fixed cable. <sup>b</sup> Except at active electrode areas.

## Measuring Ranges 2 - Electrode Design Sensors

Sensors	Transmitters				
	M300	M400 4 - W	M400 2 - W	M800 1 - channel	System Accuracy (±)
InPro 7000-VP/7005-VP	0.02–2000	0.02–2000	0.02–2000	0.02–2000	3%
InPro 7001-VP	0.02–500	0.02–500	0.02–500	0.02–500	3%
InPro 7002-VP	0.02–2000	0.02–2000	0.02–2000	0.02–2000	3%

all values in μS/cm

<b>Suitable Housings</b>	<b>p.</b>
InTrac 781 .....	135

## InPro 7100-VP 4-Electrode Design



InPro 7108-25-VP

InPro 7108-VP/PEEK



InPro 7108-TC-VP

InPro 7108-VP/CPVC



InPro 7108-VAR

The InPro 7100-VP series conductivity sensors utilize 4-electrode technology to expand the range of contacting conductivity for the measurement of medium to high conductivity solutions. The rugged sensor design withstands the most rigorous CIP/SIP procedures in food and pharmaceutical industries. Series includes process connections for industrial processing as well as hygienic 25 mm port and Tri-Clamp fittings.

### Ordering Information

InPro 7100-VP Series 4-Electrode Sensors	Order Number
InPro 7108-VP/CPVC	52 002 001
InPro 7108-VP/PEEK	52 002 002
InPro 7108-VP/PEEK/HA-C22	52 002 003
InPro 7108-VP-25/40-VP	52 002 004
InPro 7108-VP-25/40/HA-C22-VP	52 002 005
InPro 7108-VP-25/65-VP	52 002 006
InPro 7108-VP-25/65/HA-C22-VP	52 002 007
InPro 7108-VP/1.5" TC-VP	52 002 008
InPro 7108/2" TC-VP	52 002 009
InPro 7108-VAR-VP 3.1	52 002 790

Cables	Order Number
1.5 m (4.9 ft)	58 080 201
3.0 m (9.8 ft)	58 080 202
4.5 m (14.8 ft)	58 080 203
7.5 m (24.6 ft)	58 080 204
15.0 m (49.2 ft)	58 080 205
25.0 m (82.0 ft)	58 080 206
30.0 m (98.4 ft)	58 080 207
Adapter (VP to old patch cord, 1 m/3.3 ft)	58 080 101

### Features Overview

- No polarization effects
- Withstands over 200 sterilization cycles (where applicable)
- Smooth flat surfaces resist fouling
- Watertight VarioPin connector (IP68) for easy connection and excellent signal transmission
- MaxCert certification package includes NIST/ASTM traceable cell constant, 3.1 materials certificate, and FDA compliant materials documentation

- WideRange technology for wide measuring range and compact, cost-efficient installation

### Typical Applications

- Chemical concentration measurement/control
- Detection of phase separation
- Control of CIP processes
- Wastewater monitoring

[www.mt.com/InPro7100](http://www.mt.com/InPro7100)

## Specifications

	InPro 7108–VP/CPVC	InPro 7108–VP/PEEK	InPro 7108–25-VP	InPro 7108–TC–VP InPro 7108–VAR–VP
Measuring principle	4-electrode sensor	4-electrode sensor	4-electrode sensor	4-electrode sensor
Electrode material	316L	Sterilizable 316L or HA-C22	Sterilizable 316L or HA-C22	Sterilizable 316L
Body material	CPVC	PEEK	PEEK	PEEK
RTD	Built-in Pt 1000	Built-in Pt 1000	Built-in Pt 1000	Built-in Pt 1000
Insertion length	28 mm (1.10")	28 mm (1.10")	40/65 mm (1.57/2.56")	25 mm (0.98")
Max. sensor length	151 mm (5.96")	126.7 mm (4.99")	123/148 mm (4.86/5.84")	105 mm (4.14")
Process connection	1" NPT 1" NPT conduit	1" NPT	DN25	Tri-Clamp 1.5" Tri-Clamp 2" Tuchenhagen- Varivent DN 40–DN125
Measuring range	See separate table on page 85			
Cell constant nominal	0.25 cm <sup>-1</sup>	0.25 cm <sup>-1</sup>	0.25 cm <sup>-1</sup>	0.25 cm <sup>-1</sup>
<b>Working Conditions</b>				
Max. pressure at 25 °C (77 °F)	7 bar (100 psig)	17 bar (246 psig)	17 bar (246 psig)	17 bar (246 psig)
Max. pressure at 95 °C (203 °F)	–	7 bar (100 psig)	7 bar (100 psig)	7 bar (100 psig)
Measuring temperature range	–10...80 °C (14...176 °F)	–10...140 °C <sup>a</sup> (14...284 °F)	–10...140 °C <sup>a</sup> (14...284 °F)	–10...140 °C <sup>a</sup> (14...284 °F)
Temperature range (sterilization)	N/A	Sterilizable –10...140 °C <sup>a</sup> (14...284 °F)	Sterilizable –10...140 °C <sup>a</sup> (14...284 °F)	Sterilizable –10...140 °C <sup>a</sup> (14...284 °F)
Temperature accuracy at 25 °C (77 °F)	±0.25 °C ±0.5 °F	±0.25 °C ±0.5 °F	±0.25 °C ±0.5 °F	±0.25 °C ±0.5 °F
<b>Design</b>				
Temperature compensation	Pt 1000 IEC class A	Pt 1000 IEC class A	Pt 1000 IEC class A	Pt 1000 IEC class A
Cable connection	Vario Pin (IP 68)	Vario Pin (IP 68)	Vario Pin (IP 68)	Vario Pin (IP 68)
Wetted parts:				
– Metals	316L	316L or HA-C22	316L or HA-C22	316L
– Plastics	CPVC	PEEK (FDA)	PEEK (FDA)	PEEK (FDA)
– O-rings	N/A	N/A	EPDM (FDA)	N/A
<b>Certificates and Approvals</b>				
Cell constant	•	•	•	•
CE certificate	•	•	•	•
Material certificates				
EN 10204 3.1	•	•	•	•
Material confirmation 2.1	•	•	•	•
ATEX (II 1/2G Ex ia)	•	•	•	•

<sup>a</sup> Short term 150 °C (302 °F)

## InPro 7100 (i) Convenient Sensors for All Your Processes



InPro 7100

InPro 7100i

### Features Overview

- Wide measurement range (0.02 – 500 mS/cm, depending on the transmitter)
- High resistance against aggressive chemicals
- Compatible with a variety of our static and retractable housing
- WideRange technology

The InPro 7100 is particularly suited for applications in the Chemical Industry, Pharmaceutical Industry, Food & Beverage and Pulp & Paper. The fast response time allows quick detection of process changes, leading to better process control. The PEEK shaft material offers high resistivity against aggressive solutions and is particularly suitable in process with frequent CIP/SIP cycles. The InPro 7100 is compatible with a variety of static (InDip™ or InFit™ series) and retractable (InTrac™ series) housings giving the user a wide choice of installation options.

### Specifications

#### Performance

Cell constant nominal	0.31 cm <sup>-1</sup>
System accuracy	± 5 % or better
Operation range	0 to 20 bar at 135 °C (0 to 290 psi at 275 °F) 0 to 10 bar at 150 °C (0 to 145 psi at 302 °F)
Temperature range (sterilization)	Sterilizable –20 to 150 °C (–4 to 302 °F)
Temperature accuracy at 25 °C (77 °F)	± 0.1 °C (± 0.1 °F)

#### Construction

Measuring principle	4-electrode sensor
Electrode material	SS 316L/1.4435 Hastelloy C22
Body material	PEEK
RTD	Built-in Pt1000
Sensor diameter	12 mm
Sensor length	120 mm (4.72"), 225 mm (8.85"), 425 mm (16.73")
Process connection	Pg 13.5, (with InFit series: Tri-Clamp 1.5", Tri-Clamp 2", Cap nut DN 25)

#### Design

Temperature compensation	Pt 1000 IEC class A
Cable connection	InPro 7100: Vario Pin (IP 68); InPro 7100i: AK9
Wetted parts:	– Metals: SS 316L/1.4435 or Hastelloy C22 – Plastics: PEEK (FDA; USP Class VI)

#### Certificates and Approvals

Cell constant, ATEX, Material certificate 2.1 and 3.1, CE

### ISM Features

- Digital connector
- Plug and Measure functionality

### Typical Applications

- Chemical concentration control
- Control of CIP processes
- Control of digesting and bleaching (Pulp & Paper)
- Detection of phase separation (Food & Beverages)
- Buffer preparation (Pharma)

► [www.mt.com/InPro7100](http://www.mt.com/InPro7100)

## Ordering Information

### InPro 7100

Sensor	Order Number
InPro 7100/12/120/4435	52 003 571
InPro 7100/12/120/C22_	52 003 572
InPro 7100/12/425/4435	52 003 793
InPro 7100/12/425/C22_	52 003 794

### InPro 7100 i

Sensor	Order Number
InPro 7100i/12/120/4435	52 003 791
InPro 7100i/12/120/C22_	52 003 792
InPro 7100i/12/225/4435	30 095 803
InPro 7100i/12/425/4435	52 003 880
InPro 7100i/12/425/C22_	52 003 881

### Patch Cables

1.5m (5ft)	58 080 201
3.0m (10ft)	58 080 202
4.6m (15ft)	58 080 203
7.6m (25ft)	58 080 204
15.2m (50ft)	58 080 205
22.9m (75ft)	58 080 206
30.5m (100ft)	58 080 207

### AK9 Coax Cables with K8S Connector for ISM sensors

Cable Socket	Termination	Cable Length	Order Number
AK9	Tinned ends	1 m (3.3ft)	59 902 167
AK9	Tinned ends	3 m (9.8ft)	59 902 193
AK9	Tinned ends	5 m (16.4ft)	59 902 213
AK9	Tinned ends	10 m (32.8ft)	59 902 230
AK9	Tinned ends	20 m (65.6ft)	52 300 204

For accessories, cables and cable lengths refer to page 146.

### Measuring Ranges 4-Electrode Design Sensors

Sensors	Transmitters						System Accuracy (±)
	M100	M200	M300	M400 4-W	M400 2-W	M800	
InPro 7108	–	–	0.02–650	0.02–650	0.02–650	0.02–650*	5 %
InPro 7100	–	–	0.02–400	0.02–400	0.02–400	0.02–400*	5 %
InPro 7100i	0.02–500	0.02–500	0.02–500	0.02–500	0.02–500	0.02–500	5 %

All values in mS/cm

\* M800 1-channel only

Suitable Housings	p.
InTrac 781 .....	135

## InPro 7250 Inductive Conductivity Sensors



### Features Overview

- Inductive design ideal for dirty applications or process chemical concentration measurement
- No polarization effects
- High temperature model suitable for boiler blowdown applications
- Chemically resistant PEEK body for very aggressive chemicals
- PFA version available for harsh environments
- Robust design for maintenance-free operation
- Available bushings and flanges simplify installation

► [www.mt.com/InPro7250](http://www.mt.com/InPro7250)

The InPro 7250 Series conductivity sensors are inductive sensors designed to handle aggressive chemical solutions or dirty water applications. These “electrodeless” sensors have no electrodes in contact with the sample and are not affected by coatings that foul traditional contacting conductivity sensors. Able to measure medium to very high conductivity levels, applications range from measurement of industrial wastewater to acid, caustic, and salt stream concentration in industrial processing.

### Specifications

High Temperature (HT)	PEEK	PFA
Measurement range	0–2,000 mS/cm	0–2,000 mS/cm
Temperature range	–20 to 180 °C (–4 to 356 °F)	–20 °C to 125 °C (–4 to 257 °F)
Pressure range at 25 °C (77 °F)	0–20 bar (0–290 psi)	0–16 bar (0–232 psi)
Sensor material	PEEK, glass filled	PFA, not glass filled
Seal material	Viton®	PTFE
Temperature sensor	Pt 1000	Pt 1000
Cell factor	2.175	2.30
Process connection	G ¾"	G ¾"
Cable length	3 m, 5 m, 10 m (9.8 ft, 16.4 ft, 32.8 ft)	3 m, 5 m, 10 m (9.8 ft, 16.4 ft, 32.8 ft)
<b>Certificates and Approvals</b>	ATEX: • FM: • CE: •	• • •

### Standard

Temperature (ST)	PEEK
Measurement range	0–2,000 mS/cm
Temperature range	–20 to 100 °C (–4 to 212 °F)
Pressure range at 25 °C (77 °F)	0–8 bar (0–116 psi)
Sensor material	PEEK, glass filled
Seal material	Viton®
Temperature sensor	Pt 1000
Cell factor	2.175
Process connection	G ¾"
Cable length	3 m, 5 m, 10 m (9.8 ft, 16.4 ft, 32.8 ft)
<b>Certificates and Approvals</b>	CE: •

## Ordering Information

Sensors	Order Number
InPro 7250 ST/Pt1000/3m (9.8ft)	52 002 736
InPro 7250 ST/Pt1000/5m (16.4ft)	52 002 737
InPro 7250 ST/Pt1000/10m (32.8ft)	52 002 738
InPro 7250 HT/Pt1000/3m (9.8ft)	52 002 739
InPro 7250 HT/Pt1000/5m (16.4ft)	52 002 740
InPro 7250 HT/Pt1000/10m (32.8ft)	52 002 741
InPro 7250 PFA/Pt1000/3m (9.8ft)	52 005 423
InPro 7250 PFA/Pt1000/5m (16.4ft)	52 005 424
InPro 7250 PFA/Pt1000/10m (32.8ft)	52 005 425

Other sensor cable lengths are available. Please contact METTLER TOLEDO for details.

Process Connections and Accessories	Order Number	
<b>– Flanges</b>		
Flange DN 50/PN16	52 403 565	
Flange ANSI 2"	52 403 567	
Flange ANSI 3"	52 403 569	
Flange DN50/PN16, PVDF, only for PFA version	52 403 946	
Flange ANSI 2", incl. Sealing Plate PTFE	52 403 947	
<b>– Bushings</b>		
Bushing R 1½"	52 403 446	
Bushing R 1½", PVDF	52 403 447	
Bushing R 2"	52 403 448	
Bushing R 2", PVDF	52 403 449	
Bushing 1½" NPT	52 403 450	
Bushing 1½" NPT, PVDF	52 403 451	
Bushing 2" NPT	52 403 452	
Bushing 2" NPT, PVDF	52 403 453	
<b>– Sanitary Adapters</b>		
Dairy adapter DN50	52 403 583	
Aseptic adapter DN50	52 403 584	
<b>– InDip 550 Ind – Sensor holder spare part set</b>		
InDip 550ind PVC	52 403 579	
InDip 550ind PVDF	52 403 580	
<b>– Accessories</b>		
Flat gasket (Viton®)	52 403 432	
O-ring (Viton®)	52 750 171	
Locknut (stainless steel)	52 403 433	
<b>Transmitter M400 (4-Wire Transmitter)</b>	<b>Designation</b>	<b>Order Number</b>
M400, Type 1 Cond Ind	–	52 121 495
<b>Transmitter M400 (2-Wire Transmitter)</b>	<b>Designation</b>	<b>Order Number</b>
M400 2XH Cond Ind	–	30 256 307

# Transmitters for All Parameters

## Your Access to the Process

### Constant information

Transmitters are the components that communicate to the user and translate sensor readings into displayed measurements. METTLER TOLEDO provides tailorable transmitter solutions to meet the needs of a wide range of applications and functional requirements. Intelligent diagnostics keep users informed of sensor "health".

### Single- or multi-channel?

For simpler processes where only a single parameter requires measurement, a single-channel transmitter is the obvious choice, but for processes where more than one parameter must be monitored, multi-channel, multi-parameter transmitters offer sig-

nificant advantages. METTLER TOLEDO multi-channel transmitters combine operating flexibility with ease of use.

### Transmitters for hazardous areas

Many of our transmitters have been designed specifically for hazardous area use where there is a risk of explo-



	M200 (p. 88–89)	M300 (p. 90–91)	M400 (p. 92–95)	M800 (p. 98–101)	
	4-Wire				
<b>Channels</b>	1/2	1/2	1	1/2/4*	
<b>Plug and Measure</b>	•	•	•	•	
<b>Dynamic Lifetime Indicator (DLI)</b>	–	•	•	•	
<b>Adaptive Calibration Timer (ACT)</b>	–	•	•	•	
<b>Time To Maintenance (TTM)</b>	–	•	•	•	
<b>Calibration history</b>	–	•	•	•	
<b>CIP/SIP autoclaving counter</b>	–	•	•	•	
<b>iMonitor</b>	–	•	•	•	
<b>Communication</b>	–	–	HART® Foundation Fieldbus*	Profinet* Ethernet/IP*	
<b>Panel Cutout</b>	½ DIN, ¼ DIN	½ DIN, ¼ DIN	½ DIN	½ DIN	
<b>Mixed-mode input</b>	–	•	•*	•*	
<b>PID controller</b>	–	•	•	•	
<b>Hold input</b>	•	•	•	•	
<b>Analog input</b>	–	–	1*	1	
<b>Digital input</b>	1/2	1/2	2	4/5/6	
<b>Relays/open collectors (OC)</b>	2	4*	4	8/2/0*	
<b>Outputs</b>	2/4	2/4	4	8/1/0*	
<b>Approvals</b>	UL	UL	ATEX IECEx Zone 2 FM CI 1 Div 2 CSA CI 1 Div 2* NEPSI	FM CI 1 Div 2*	
<b>Parameter compatibility (Ingold)</b>					
<b>pH/ORP/pNa</b>	•	•	•	•	
<b>Dissolved oxygen</b>					
Amperometric sensors					
High (InPro 68xxi)	•	•	•	•	
Low (InPro 69xxi)	–	–	•*	•	
Optical sensors					
High (InPro 68xx)	–	–	•	•	
Low (InPro 69xx)	–	–	•*	•	
<b>Gaseous oxygen</b>					
High (InPro 68xx)	–	–	•*	•	
Low (InPro 69xx)	–	–	•*	•	
GPro 500	–	–	•*	–	
<b>CO<sub>2</sub></b>					
InPro 5000i	–	–	•*	•	
InPro 5500i	–	–	•*	•	
<b>Conductivity 2-e/4-e</b>	•	•	•	•	
<b>Inductive conductivity</b>	–	–	•*	–	
<b>Turbidity</b>	–	–	–	•*	
<b>Ozone</b>	•	•	•*	–	
<b>EasyClean compatibility</b>	•	•	•	•	



sive or toxic environments. Low-power, 2-wire units with ATEX/FM approvals ensure operating safety.

### Digital communication

We offer transmitters for all common digital communication protocols for easy interface with your DCS or PLC. Intelligent Sensor Management (ISM) diagnostics data can also be accessed on control systems to provide an over-

view of the performance of all measurement systems from one point.

### The way forward

Use of digital sensors is becoming increasingly common in the process industries. Many of our transmitters accept traditional analog as well as ISM digital sensors, providing a future oriented investment in your plant. Our latest transmitter developments

include the M400 and M300 Process multi-parameter units. Their touchscreen display and intuitive menus save operating time, while predictive maintenance ensures reliability and reduced maintenance. The M100 series has been designed to provide the ultimate solution for measurement point simplicity. This displayless transmitter sets a new standard in measuring system simplicity and efficiency.



	<b>M80 SM</b> (p. 104)	<b>M100 SM</b> (p. 103)	<b>M100 DR</b> (p. 102)	<b>M400 2(X)H</b> (p. 106–109)	<b>M400 FF</b> (p. 110–111)	<b>M400 PA</b> (p. 110–111)
				<b>2-Wire</b>		
	1	1	1	1	1	1
	•	•	•	•	•	•
	•	•	•	•	•	•
	•	•	•	•	•	•
	•	•	•	•	•	•
	•	•	•	•	•	•
	–	–	–	–	–	–
	<b>Modbus RTU</b>	<b>BT 4.0 Modbus RTU</b>	<b>HART®</b>	<b>HART®</b>	<b>Foundation Fieldbus*</b>	<b>Profibus PA</b>
	–	–	–	½ DIN	½ DIN	½ DIN
	–	–	–	•	•	•
	–	–	–	•	•	•
	–	–	•	•	–	–
	–	–	1	1	1	1
	–	–	1	2	2	2
	–	–	–	2	–	–
	–	2	1	2	–	–
	–	–	–	<b>ATEX IECEx Zone 1* FM CI 1 Div 1/2* NEPSI*</b>	<b>ATEX IECEx Zone 1 FM CI 1 Div 1 NEPSI</b>	<b>ATEX IECEx Zone 1 FM CI 1 Div 1 NEPSI</b>
	•	•	•	•	•	•
	•	•	•	•	•	•
	–	–	•	•	•	•
	–	•	–	–	•	•
	–	–	–	–	•	•
	–	–	–	•*	•	•
	–	–	–	•*	•	•
	–	–	–	–	–	–
	•	•	–	–	•	•
	–	–	–	–	–	•
	•	–	•	•	•	•
	–	–	–	•*	–	–
	–	–	–	–	–	–
	–	–	–	–	–	–
	–	–	–	•	•	•

\* Model dependent

## M200: Convenient and Reliable For Basic Process Applications



The M200 multi-parameter transmitter line covers pH, ORP, dissolved oxygen, ozone and conductivity measurements. Plug and Measure provides compatibility and reliable operation for ISM sensors as well as the complete digital easySense line. Convenient operation thanks to the large display, plain text interface, quick access menu and easily accessible wiring terminals. With the Transmitter Configuration Tool (TCT) provided for the M200 commissioning as well as maintenance becomes substantially easier.

### Specifications

Measurement parameters	pH, ORP, dissolved oxygen, conductivity and ozone
ISM	Plug and Measure
Power supply	100V to 240VAC or 20 to 30VDC, 10 VA
AC Frequency	50 to 60 Hz
Current (analog) outputs	2 × or 4 × 0/4 – 20 mA, 22 mA alarm, galvanically isolated from input and from earth/ground
User interface	Backlit LCD, 4 lines
Languages	8 (English, German, French, Italian, Spanish, Portuguese, Russian and Japanese)
Ambient temperature	–10 to 50 °C (14 to 122 °F)
Relative humidity	0 to 95 % non-condensing
Rating	IP65
Hold input	yes
Control input	2 (1 for single channel)
Relays	2-SPDT (alarm delay 0 to 999 s)

### Features Overview

- Plug and Measure for easy operation and maintenance
- Input for digital ISM sensor signals and easySense sensors
- Multi-parameter unit
- 1 or 2-channel version
- 2 configurable relays
- IP65 rated
- 8 languages: English, German, French, Italian, Spanish, Portuguese, Russian and Japanese

### Other Highlights

- 4-wire installation
- Quick setup mode for fast commissioning
- Free Transmitter Configuration Tool (TCT) software

► [www.mt.com/M200](http://www.mt.com/M200)

## Parameter Specifications

### pH/ORP

Measurement parameters	pH, mV and temperature
pH range	-2.00 to 16.00 pH
ORP input range	-1500 to 1500 mV
pH resolution	Auto/0.01/0.1/1 (can be selected)
pH accuracy	±1 digit
Temperature measuring range	-30 to 130 °C (-22 to 266 °F)
Temperature resolution	Auto/0.001/0.01/0.1/1 °C/°F (can be selected)
Temperature accuracy	±1 digit
Calibration	1-point (offset), 2-point, process
Sensor maximum distance	80 m (260 ft)

### Dissolved oxygen

Measurement parameters	Dissolved oxygen (DO) saturation or concentration and temperature
DO concentration range	0.00 to 50.00 ppm (mg/L)
DO saturation range	0 to 500 %, air, 0 to 0 to 200 % O <sub>2</sub>
DO resolution	Auto/0.001/0.01/0.1/1 (can be selected)
DO accuracy	±1 digit
Temperature measuring range	-10 to +80 °C (14 to 176 °F)
Temperature resolution	Auto/0.001/0.01/0.1/1 °C/°F (can be selected)
Temperature accuracy	±1 digit
Calibration	1-point (slope or offset), process (slope or offset)
Sensor maximum distance	80 m (260 ft)

### Conductivity

Measurement parameters	Conductivity and temperature
Cond range 2-electrode sensor	0.1 to 40000 mS/cm (25 Ω × cm to 100 MΩ × cm)
Cond range 4-electrode sensor	0.01 to 650 mS/cm (1.54 Ω × cm to 0.1 MΩ × cm)
Cond / Res resolution	Auto/0.001/0.01/0.1/1 (can be selected)
Cond / Res accuracy	± 1 digit
Temperature measuring range	-40 to 200 °C (-40 to 392 °F)
Temperature resolution	Auto/0.001/0.01/0.1/1 °C/°F (can be selected)
Temperature accuracy	±1 digit
Chemical concentration curves	NaCl 0–26 % @ 0 °C to 0–28 % @ +100 °C NaOH 0–12 % @ 0 °C to 0–16 % @ +40 °C to 0–6 % @ +100 °C HCl 0–18 % @ -20 °C to 0–18 % @ 0 °C to 0–5 % @ +50 °C HNO <sub>3</sub> 0–30 % @ -20 °C to 0–30 % @ 0 °C to 0–8 % @ +50 °C H <sub>2</sub> SO <sub>4</sub> 0–26 % @ -12 °C to 0–26 % @ +5 °C to 0–9 % @ +100 °C H <sub>3</sub> PO <sub>4</sub> 0–35 % @ +5 °C to 80 °C TDS ranges NaCl, CaCO <sub>3</sub>
Calibration	1-point (slope), 2-point, process
Sensor maximum distance, DS 4-e	80 m (260 ft)
Sensor maximum distance ISM 2-e	90 m (300 ft)

## Ordering Information

Transmitter	Order Number
M200, ¼ DIN, single-channel	52 121 554
M200, ½ DIN, single-channel	52 121 555
M200, ¼ DIN, dual-channel	52 121 556
M200, ½ DIN, dual-channel	52 121 557

## Accessories

	Order Number
Pipe mounting kit for ½ DIN	30 300 480
Panel mounting kit for ½ DIN	52 500 213
Protective hood	52 500 214
Terminal blocks for M200, M300, M400	52 121 504

Detailed description and order information for easySense sensors and fittings see page 225–226.

## M300 Process: Versatile and User-Friendly For a Wide Range of Applications and Industries



### Features Overview

- 4.0" touchscreen
- Multi-parameter transmitter for pH/ORP, DO, ozone and cond
- Available as single-channel or dual-channel version
- PID controller with pulse length, pulse frequency or analog control
- User management available

### Other Highlights

- Mixed-mode functionality allows the connection of analog or digital ISM sensors
- Full ISM diagnostics available
- 4-wire installation
- Also communicates with EasyClean systems for automatic sensor cleaning

► [www.mt.com/M300](http://www.mt.com/M300)

The multi-parameter M300 Process transmitter line for pH/ORP, dissolved oxygen, dissolved ozone and conductivity measurements offers exceptional measurement performance as well as excellent user ergonomics.

The high contrast black and white touchscreen together with the harmonized menu structure for all parameters, facilitates navigation and ensures easy and user friendly operation.

On-line diagnostics information allows you to schedule sensor maintenance or replacement. The clearly visible diagnostic information lets you know when it's time to do maintenance or calibration of sensors equipped with Intelligent Sensor Management (ISM) technology.

The integrated USB interface allows you to use it for data logging or to store the configuration on a USB stick.

### Specifications

Power supply	100 to 240 VAC, or 20 to 30 VDC, 10 VA
Frequency for AC	50 to 60 Hz
Current output	2 × 0/4 to 20 mA (4× for dual channel), 22 mA alarm (according to Namur NE43)
Display	4.0" b/w touchscreen, 320 × 240 pixel
Languages	10 (English, German, French, Italian, Spanish, Portuguese, Russian, Japanese, Korean and Chinese)
Ambient temperature	–10 to 50 °C (14 to 122 °F)
Relative humidity	0 to 95% non-condensing
Rating	¼ DIN: IP65 (front) ½ DIN: IP65
PID controller	Yes
Control input (Hold)	1 or 2 (dual channel version)
Relays	2 × SPST, 2 × reed
Approvals and certificates	cULus
USB interface	1 × USB Host: Data logging and configuration storage on USB stick 1 × USB Device: Software update interface

### Parameter Specifications

pH Performance	
Measurement parameters	pH, mV, and temperature
pH, ORP input range*	– 1500 to 1500 mV
pH display range	–2 to 16 pH
pH resolution	Auto/0.01/0.1/1 (can be selected)
Relative accuracy**	± 0.02 pH; ± 1 mV
Temperature input*	Pt1000 (Pt100 with adapter)
Temperature measuring range	–30 to 130 °C (–22 to 266 °F)
Temperature accuracy**	± 0.25 °C (± 0.45 °F)
Sensor maximum distance	Analog: 10 to 20 m (33 to 65 ft) ISM: 80 m (260 ft)
Calibration	1- or 2-point, process

\* not required for ISM sensors

\*\* for analog input signal (ISM signal causes no additional error)

## Parameter Specifications (cont.)

### DO Performance

Measurement parameters	DO saturation or concentration and temperature
Measuring current range	0 to 900 nA
DO concentration range	0.00 to 50.00 ppm (mg/L)
DO accuracy	± 0.5% of full scale reading
DO resolution	Auto/0.001/0.01/0.1/1 (can be selected)
Temperature input*	NTC 22
Temperature measuring range	-10 to 80 °C (14 to 176 °F)
Temperature accuracy**	± 0.25 °C (± 0.45 °F)
Sensor maximum distance	Analog: 20 m (65 ft). ISM: 80 m (260 ft)
Calibration	1-point (slope or offset), process (slope or offset)

\* not required for ISM sensors \*\* for analog input signal (ISM signal causes no additional error)

### Conductivity Performance

Measurement parameters	Conductivity, and temperature
Conductivity/resistivity ranges	2-electrode sensor display range: 0 to 40,000 mS/cm (25 Ω × cm to 100 MΩ × cm) 4-electrode sensor display range: 0.01 to 650 mS/cm (1.54 Ω × cm to 0.1 MΩ × cm)
Temperature input*	Pt 1000
Temperature measuring range	-40 to 200 °C (-40 to 392 °F)
Sensor maximum distance	Analog 2-e: 61 m (200 ft); analog 4-e: 15 m (50 ft) ISM 2-e: 90 m (300 ft); ISM 4-e: 80 m (260 ft)
Cond/Res accuracy**	± 0.5% of reading or 0.25 Ω, whichever is greater
Cond/Res repeatability	± 0.25% of reading or 0.25 Ω, whichever is greater
Cond/Res resolution	Auto/0.001/0.01/0.1/1 (can be selected)
Temperature resolution	Auto/0.001/0.01/0.1/1 °C (°F) (can be selected)
Temperature accuracy**	± 0.25 °C (± 0.45 °F)
Temperature repeatability**	± 0.13 °C (± 0.23 °F)

\* not required for ISM sensors \*\* for analog input signal (ISM signal causes no additional error)

### Dissolved Ozone Performance

Measurement parameters	Concentration and temperature
Display range for current	Analog: 0 to -7000 nA
Ozone measuring range	Short term: 0 to 5.00 ppm (mg/L) O <sub>3</sub> Continuous: 0 to 500 ppb (µg/L) O <sub>3</sub>
Ozone accuracy*	Analog: ± 0.5% of reading or ± 5 ppb
Resolution	± 1 digit
Temperature compensation	Automatic
Temperature measuring range	0 to 50 °C (32 to 122 °F)
Temperature resolution	Auto/0.001/0.01/0.1/1 (can be selected)
Temperature accuracy*	Analog: ± 0.25 °C (± 0.45 °F)
Sensor maximum distance	80 m (260 ft)
Calibration	1-point (offset) or process (slope and offset)

\* for analog input signal (ISM input signal causes no additional error)

## Ordering Information

### For Analog Sensors

	Order Number
M300 Process, ¼ DIN, single-channel, multi-parameter	30 280 770
M300 Process, ½ DIN, single-channel, multi-parameter	30 280 771
M300 Process, ¼ DIN, dual-channel, multi-parameter	30 280 772
M300 Process, ½ DIN, dual-channel, multi-parameter	30 280 773

### Installation Accessories for ½ DIN Version

	Order Number
Pipe mount kit for ½ DIN	30 300 480
Panel mount kit for ½ DIN	30 300 481
Wall mounting kit for ½ DIN	30 300 482
Protective hood	30 073 328

## M400: Reliable and Intelligent Advanced Process Control



### Features Overview

- 4" touchscreen plus soft-key operation
- Advanced ISM diagnostics, incl. iMonitor
- Communication protocol: 4 to 20 mA (with HART)
- Multi-parameter measurement
- Aluminum die cast enclosure (coated)
- 4-wire installation

The multi-parameter M400 transmitter series features Intelligent Sensor Management (ISM) technology and covers pH/ORP, oxygen (for measurement of dissolved oxygen or in gas), dissolved carbon dioxide, dissolved ozone, conductivity or GPro™ 500 TDL, depending on the type you choose.

The high-contrast black and white touchscreen together with four soft keys, allows you to operate the transmitter even in the harshest applications without compromising user ergonomics. The online diagnostic information with harmonized menu display lets you know when it is time to do maintenance or calibration of sensors equipped with ISM technology. The HART or Foundation Fieldbus communication protocol provides easy integration of sensor diagnostics into process control systems.

### Specifications

#### General

Power supply	100 to 240VAC, or 20 to 30VDC, 10VA
Frequency for AC	50 to 60 Hz
Current output	4 × 0/4 to 2 mA, 22 mA alarm (according to Namur NE43) (except M400 FF 4-wire)
Display	4.0" TFT b/w touchscreen, 320 × 240 pixels
Languages	10 (English, German, French, Italian, Spanish, Portuguese, Russian, Japanese, Korean and Chinese)
Ambient temperature	-20 to +50 °C (-4 to 122 °F)
Relative humidity	0 to 95 % non-condensing
Rating	IP66 NEMA 4X
Approvals	Type 1, 2, 3: cCSAus Class I Division 2, ATEX IECEx Zone 2, FM cMus Class I Division 2, cULus NEPSI Zone 2 Foundation Fieldbus: cULus
PID process controller	Yes
Control input (Hold)	2
USB interface	1 × USB Host: Data logging and configuration storage on USB stick 1 × USB Device: Software update interface

### Other Highlights

- Plug and Measure functionality
- IP 66 rated
- Graphic trending
- Transmitter configuration tool



### Did You Know

With tools such as the Dynamic Lifetime Indicator, Time To Maintenance and Adaptive Calibration Timer, ISM technology on the M400 offers true predictive maintenance, resulting in fewer unscheduled shutdowns.

► [www.mt.com/M400](http://www.mt.com/M400)

## Parameter Specifications

### pH/ORP (incl. pH/pNa)

Measurement parameters	pH, mV and temperature
pH display range	-2.00 to +16.00 pH
pH resolution	Auto/0.001/0.01/0.1/1 (can be selected)
pH accuracy <sup>1)</sup>	Analog: ±0.02 pH
mV range	-1500 to +1500 mV
mV resolution	Auto/0.001/0.01/0.1/1 mV (can be selected)
mV accuracy <sup>1)</sup>	Analog: ±1 mV
Temperature input <sup>2)</sup>	Pt 1000/Pt 100/NTC 22k
Temperature measuring range	-30 to +140 °C (-22 to +284 °F)
Temperature resolution	Auto/0.001/0.01/0.1/1 (can be selected)
Temperature accuracy <sup>1)</sup>	Analog: ±0.25 °C (±0.45 °F)
Temperature compensation	Automatic/Manual
Max. sensor cable length	Analog: 10 to 20 m (33 to 65 ft) depending on sensor ISM: 80 m (260 ft)
Calibration	1-point, 2-point or process

1) ISM input signal causes no additional error.

2) Not required on ISM sensors

### Amperometric oxygen

Measurement parameters	Dissolved oxygen (DO): Saturation or concentration and temperature Oxygen in gas: Concentration and temperature
Measuring current range	Analog: 0 to -7000 nA
Oxygen display ranges	Dissolved oxygen Saturation: 0 to 500 % air, 0 to 200 % O <sub>2</sub> -sat Concentration: 0 ppb (µg/L) to 50.00 ppm (mg/L) In gas Saturation: 0 to 100 vol-% O <sub>2</sub> Concentration: 0 to 9999 ppb O <sub>2</sub> gas
Oxygen accuracy <sup>1)</sup>	Dissolved oxygen: Saturation ±0.5 % of the measured value or ±0.5 %, depending on which is larger. Concentration at high values: ±0.5 % of the measured value or ±0.050 ppm/±0.050 mg/L, depending on which is larger. Concentration at low values: ±0.5 % of the measured value or ±0.001 ppm/±0.001 mg/L, depending on which is larger In gas: ±0.5 % of the measured value or ±5 ppb, depending on which is larger for ppm O <sub>2</sub> gas. ±0.5 % of the measured value or ±0.01 %, depending on which is larger for vol-% O <sub>2</sub> .
DO resolution	Auto/0.001/0.01/0.1/1 (can be selected)
Polarization voltage	O <sub>2</sub> High: Cal/Meas: -675 mV (configurable) O <sub>2</sub> Low: Cal: -675 mV, Meas: -500 mV (configurable)
Temperature input	Pt 1000/Pt 100/NTC 22k
Temperature compensation	Automatic
Temperature measuring range	-10 to +80 °C (+14 to +176 °F)
Temperature resolution	Auto/0.001/0.01/0.1/1 °C (°F) (can be selected)
Temperature accuracy <sup>1)</sup>	±0.25 °C (±0.45 °F)
Max. sensor cable length	Analog: 20 m (65 ft) ISM: 80 m (260 ft)
Calibration	1-point (slope and offset) or process (slope and offset)

1) ISM input signal causes no additional error.

### Optical oxygen

Measurement parameters	Dissolved oxygen (DO): Saturation or concentration and temperature Oxygen in gas: Concentration and temperature
Oxygen display ranges	Dissolved oxygen Saturation: 0 to 500 % air, 0 to 200 % O <sub>2</sub> -sat Concentration: 0 ppb (µg/L) to 50.00 ppm (mg/L) In gas Saturation: 0 to 100 vol-% O <sub>2</sub> Concentration: 0 to 9999 ppb O <sub>2</sub> gas
Oxygen accuracy	±1 digit
Oxygen resolution	Auto/0.001/0.01/0.1/1 (can be selected)
Temperature compensation	Automatic
Temperature measuring range	-30 to +150 °C (-22 to +302 °F)
Temperature resolution	Auto/0.001/0.01/0.1/1 °C (°F) (can be selected)
Temperature accuracy	±1 digit
Max. sensor cable length	80 m (260 ft)
Calibration	1-point (depending on sensor model) 2-point or process, process scaling

### Dissolved carbon dioxide

Measurement parameters	Dissolved carbon dioxide and temperature
CO <sub>2</sub> display range	0 to 5000 mg/L 0 to 200% sat 0 to 1500 mm Hg 0 to 2000 mbar 0 to 2000 hPa
CO <sub>2</sub> accuracy	± 1 digit
CO <sub>2</sub> resolution	Auto/0.001/0.01/0.1/1 (can be selected)
mV range	-1500 to +1500 mV
mV resolution	Auto/0.01/0.1/1 mV (can be selected)
mV accuracy	± 1 digit
Total pressure range	0 to 4000 mbar
Temperature measuring range	-30 to +150 °C (-22 to +302 °F)
Temperature resolution	Auto/0.001/0.01/0.1/1 °C (°F) (can be selected)
Temperature accuracy	± 1 digit
Max. sensor cable length	80 m (260 ft)
Calibration	1-point (offset), 2-point (slope and offset) or process (offset)

### CO<sub>2</sub> hi (thermal conductivity)

Measurement parameters	Dissolved carbon dioxide and temperature
CO <sub>2</sub> display ranges	0 to 10 bar p (CO <sub>2</sub> )/0 to 145 psi p (CO <sub>2</sub> ) 0 to 15 g/L 0 to 7 V/V CO <sub>2</sub>
Accuracy in fluids <sup>1)</sup>	± 1 % of reading (within ± 5 % of calibration temperature) ± 2 % of reading over temperature range 0 to 50 °C (32 to 122 °F)
Calibration	1-point or process

1) Complete loop of sensor and transmitter

### GPro 500 TDL

Measurement parameters	O <sub>2</sub> , O <sub>2</sub> and temperature, CO (ppm), CO (%), H <sub>2</sub> O, CO <sub>2</sub> (%), H <sub>2</sub> S, HCl
Gas display ranges	0 to 100 %
Gas accuracy, resolution, repeatability and low detection limit	Depending on sensor model
Linearity	Better than 1 %
Drift	Negligible (< 2 % of measurement range between maintenance intervals)
Sampling rate	1 second
Response time (t <sub>90</sub> )	Depending on sensor model
Process pressure ranges	Depending on sensor model
Process temperature ranges	0 to 250 °C (32 to 482 °F) optional (for probe installation) 0 to 600 °C (32 to 1112 °F) with additional thermal barrier 0 to 150 °C (32 to 302 °F) (white cell)
Max. sensor cable length	40 m (130 ft) (FM version)
Calibration	1-point (offset) or process (slope or offset)

### Dissolved ozone

Measurement parameters	Concentration and temperature
Display range for current	Analog: 0 to -7000 nA
Ozone measuring range	0 to 5000 ppb (µg/L) O <sub>3</sub>
Ozone accuracy	± 1 % (or 0.4 ppb) up to 2000 ppb ± 2.5 % (or 50-125 ppb) from 2000 to 5000 ppb
Resolution	± 1 digit
Temperature compensation	Automatic
Temperature measuring range	5 to +50 °C (+41 to +122 °F)
Temperature resolution	Auto/0.001/0.01/0.1/1 (can be selected)
Temperature accuracy 1)	Analog: ± 0.25 °C (± 0.45 °F)
Max. sensor cable length	80 m
Calibration	1-point (offset) or process (slope and offset)



### Conductivity 2-e/4-e

Measurement parameters	Conductivity/resistivity and temperature
Conductivity ranges	See sensor specification
Chemical concentration curves (used with 4-e sensors)	NaCl: 0–26 % @ 0 °C to 0–28 % @ +100 °C NaOH: 0–12 % @ 0 °C to 0–16 % @ + 40 °C to 0–6 % @ +100 °C HCl: 0–18 % @ –20 °C to 0–18 % @ 0 °C to 0–5 % @ +50 °C HNO <sub>3</sub> : 0–30 % @ –20 °C to 0–30 % @ 0 °C to 0–8 % @ +50 °C H <sub>2</sub> SO <sub>4</sub> : 0–26 % @ –12 °C to 0–26 % @ +5 °C to 0–9 % @ +100 °C H <sub>3</sub> PO <sub>4</sub> : 0–35 % @ + 5 °C to +80 °C
TDS ranges	NaCl, CaCO <sub>3</sub>
Cond/Res accuracy <sup>1)</sup>	Analog: ±0.5 % of reading or 0.25 Ω, whichever is greater
Cond/Res repeatability <sup>1)</sup>	Analog: ±0.25 % of reading or 0.25 Ω, whichever is greater
Cond/Res resolution	Auto/0.001/0.01/0.1/1 (can be selected)
Temperature input	PT1000
Temperature measuring range	–40 to +200 °C (–40 to +392 °F)
Temperature resolution	Auto/0.001/0.01/0.1/1 (can be selected)
Temperature accuracy (±0.90 °F) outside	Analog: ±0.25 °C (±0.45 °F) within –30 to +150 °C (–22 to +302 °F); ±0.50 °C
Max. sensor cable length	Analog: 2-e sensors: 61 m (200 ft); 4-e sensors: 15 m (50 ft) ISM: 2-e sensors: 90 m (300 ft); 4-e sensors: 80 m (260 ft)
Calibration	1-point, 2-point or process

1) ISM input signal causes no additional error.

### Ordering information

Transmitter	Order Number
M400 Type 1 ISM	30 490 171
M400 Type 2 ISM	30 490 172
M400 Type 1 Cond Ind	52 121 495
M400 Type 1	30 374 111
M400 Type 2	30 374 112
M400 Type 3	30 374 113
M400 FF 4-wire	30 374 121

### Installation Accessories

	Order Number
Pipe mounting kit for ½ DIN	30 300 480
Panel mount kit for ½ DIN	30 300 481
Wall mounting kit for ½ DIN	30 300 482
Protective hood	30 073 328

### M400 Parameter Fit Guide

	M400 Type 1 *		M400 Type 2 *		M400 Type 3		M400 FF 4-Wire		M400 Type 1 Cond Ind	
	Analog	ISM	Analog	ISM	Analog	ISM	Analog	ISM	Analog	ISM
pH/ORP	•	•	•	•	•	•	•	•	–	•
pH/pNa	–	•	–	•	–	•	–	•	–	•
UniCond 2-e/4-e	•	•	•	•	•	•	•	•	–	–
Conductivity 2-e	•	–	•	–	•	–	•	–	–	–
Conductivity 4-e	•	•	•	•	•	•	•	•	–	•
Amp. DO ppm/ppb/trace	–	–	•/• <sup>1)</sup> /–	•/• <sup>1)</sup> /–	•/•/•	•/•/•	•/•/•	•/•/•	–	–
Opt. DO ppm/ppb	–	–	–/–	•/• <sup>2)</sup>	–	•/•	–	•/• <sup>2)</sup>	–	–
Amp. O <sub>2</sub> gas ppm/ppb/trace	–	–	–/–/–	–/–/–	•/•/•	•/•/•	•/•/•	•/•/•	–	–
Opt. O <sub>2</sub> gas ppm	–	–	–	–	–	•	–	•	–	–
Dissolved ozone	–	–	•	•	•	•	–	•	–	–
Dissolved carbon dioxide	–	–	•	•	•	•	•	•	–	–
CO <sub>2</sub> hi	–	–	–	–	–	•	–	–	–	–
GPro 500 TDL	–	–	–	–	–	•	–	–	–	–
Inductive conductivity	–	–	–	–	–	–	–	–	•	–

\* M400 Type 1 ISM and Type 2 ISM models support ISM parameters only.

1) Thornton high performance DO sensor only.

2) Pure water optical DO sensor only.

## M400 Type 1 Cond Ind: Reliable Transmitter For Inductive Conductivity Sensors



The M400 Type 1 Cond Ind is a 4-wire, single-channel process transmitter designed specifically for use with analog inductive conductivity sensors. A large four line backlit Liquid Crystal Display conveys measuring data and setup information. The menu structure allows the operator to modify all operational parameters by using keys on the front panel. A menu-lockout feature, with password protection, is available to prevent the unauthorized use of the meter. The transmitter M400 Type1 Cond Ind can be configured to use its four analog and / or six relay outputs for process control.

### Specifications

General	
Power supply	100 to 240VAC, or 20 to 30VDC, 10VA
Frequency for AC	50 to 60Hz
Current output	4 × 0/4 to 20mA
Display	4 line backlit LCD with 5 tactile keys
Enclosure	Polycarbonate
Languages	8 (English, German, French, Italian, Spanish, Portuguese, Russian and Japanese)
Ambient temperature	-20 to 50 °C (-4 to 122 °F)
Relative humidity	0 to 95 % non-condensing
Rating	IP65
Approvals	cFMus Class I Division 2
PID process controller	Yes
Control input (Hold)	2
USB interface	1 × USB Device: Provide real-time data output, instrument configuration capabilities and software update interface via PC

### Other Highlights

#### Versatile Mixed-Mode Input

Multi-parameter transmitter for advanced process control, with analog input for inductive conductivity and digital input for pH/ORP.

#### Intelligent Measuring Solutions

Keep your process under control with ISM for low cost of ownership and real-time status information from the sensor for true predictive maintenance

#### Minimized Maintenance Costs

The ISM Plug and Measure feature allows measurement readiness within seconds. Simplified commissioning minimizes risk of installation troubles

► [www.mt.com/M400\\_Type1](http://www.mt.com/M400_Type1)

## Inductive Conductivity Specifications

Measurement ranges	See sensor specification
Chemical concentration curves	NaCl: 0–26% @ 0°C to 0–28% @ +100°C NaOH-1: 0–13% @ 0°C to 0–24% @ +100°C NaOH-2: 15–50% @ 0°C to 35–50% @ +100°C HCl-1: 0–18% @ –20°C to +50°C HCl-2: 22–39% @ –20°C to +50°C HNO <sub>3</sub> -1: 0–30% @ –20°C to +50°C HNO <sub>3</sub> -1: 35–96% @ –20°C to +50°C H <sub>2</sub> SO <sub>4</sub> -1: 0–26% @ –12°C to 0–37% @ +100°C H <sub>2</sub> SO <sub>4</sub> -2: 28–88% @ 0°C to 39–88% @ +95°C H <sub>2</sub> SO <sub>4</sub> -3: 94–99% @ –12°C to 89–99% @ +95°C H <sub>3</sub> PO <sub>4</sub> : 0–35% @ +5°C to +80°C User-defined concentration table (5×5 matrix)
TDS ranges	NaCl, CaCO <sub>3</sub>
Sensor maximum distance	10 m
Cond/Ind accuracy	±1% of reading ±0.005 mS/cm
Cond/Ind repeatability	±1% of reading ±0.005 mS/cm
Cond/Ind resolution	Auto/0.01/0.01/0.1 (can be selected)
Temperature input	Pt1000/Pt100/NTC22K
Temperature measuring range	–40 to +200.0°C (–40 to 392°F)
Temperature resolution	Auto/0.001/0.01/0.1/1 K (°F) (can be selected)
Temperature accuracy	±0.25 K (±0.45°F) within –30 to 150°C ±0.50 K (±0.90°F) outside
Temperature repeatability	±0.13 K (±0.23°F)
Max. sensor cable length	Analog: 10 to 20 m (33 to 65 ft) depending on sensor ISM: 80 m (260 ft)
Calibration	1-point, zero or process

## Ordering information

Transmitter	Order Number
M400 Type 1 Cond Ind	52 121 495

Installation Accessories	Order Number
Pipe mounting kit for ½ DIN	30 300 480
Panel mount kit for ½ DIN	30 300 481
Wall mounting kit for ½ DIN	30 300 482
Protective hood	30 073 328

## Parameter Fit Guide

For the Parameter Fit Guide for the M400 transmitters (all versions) please refer to page 95. The information for the M400 Type 1 Cond Ind is in the last column.

## M800: Multi-Parameter, Multi-Channel Transmitter

### Touch the Future



#### Features Overview

- Color touchscreen
- Intuitive operation
- Premium ISM functionality
- Multi-parameter measurement
- 1-/2-/4-channel versions
- iMonitor
- User management and logbook

#### Other Highlights

- 8 current outputs
- 8 output relays
- Traffic light coded sensor information
- IP66 rated
- 2 PID process controllers

► [www.mt.com/M800](http://www.mt.com/M800)

The M800 transmitter series features premium Intelligent Sensor Management (ISM) technology measuring pH/ORP, optical DO, amperometric oxygen (DO as well as O<sub>2</sub> gas), dissolved carbon dioxide, turbidity and conductivity. The multi-parameter transmitter accepts any compatible combination of ISM sensors. Up to four channels of process measurement provides immediate Plug and Measure installation and operation, predictive sensor maintenance and dynamic lifetime status. The color touchscreen ensures intuitive operation, with user selectable control and alarm management.

#### Specifications

##### General Specification

Measurement parameters	pH/ORP, amperometric and optical oxygen, conductivity, dissolved carbon dioxide, turbidity and temperature
ISM	Plug and Measure, advanced diagnostics (Dynamic Lifetime Indicator, Adaptive Calibration Timer, CIP/SIP counter etc.), iMonitor
Power supply	100 to 240VAC, or 20 to 30VDC, 10VA
AC frequency	50 to 60Hz
Current (analog) outputs <sup>1)</sup>	8 × 0/4 to 20 mA, 22 mA alarm
User interface	Color touchscreen 5.7", resolution 320 × 240 px, 256 colors
Languages	10 (English, German, French, Italian, Spanish, Portuguese, Russian, Japanese, Korean and Chinese)
Ambient temperature	–20 to 50 °C (–4 to 122 °F)
Relative humidity	0 to 95 %, non-condensing
Rating	IP66
PID process controller	2
Control input (Hold)	Yes
Analog input	Yes
Alarm contact	Yes (alarm delay 0 to 999 s)
Measuring range	Parameter and sensor depending
Measuring accuracy	± 1 digit (sensor depending)
Measuring repeatability	± 1 digit (sensor depending)
Measuring resolution	Auto/0.001/0.01/0.1/1 (can be selected)

1) Not supported on Profinet model; 1 current output on Ethernet/IP model.

#### Did You Know

The M800 1-channel transmitter with mixed mode functionality supports analog and digital ISM sensors.

EtherNet/IP™

**PROFINET**



**ISM**



**Other Highlights of Profinet and Ethernet/IP multi-parameter transmitters**

- Pure digital communication within loop and real-time sensor aging monitoring provides greater process reliability
- Easy integration of measurement and diagnostics data from the sensor up to the process control level
- Advanced diagnostic settings for efficient and reliable plant management

The M800 Profinet and Ethernet/IP multi-parameter transmitters bring the value of Intelligent Sensor Management technology to industrial Ethernet. They cover ISM sensors for pH/ORP, conductivity, optical DO, amperometric oxygen (DO as well as O<sub>2</sub> gas), dissolved carbon dioxide, and turbidity, and provide all ISM measurements and diagnostics information to a centralized control system for data management including predictive diagnostics. Both M800 Profinet and Ethernet/IP series provide 1-channel and 2-channel models.

Besides the intuitive operation and alarm management that provided by exist M800, the Profinet and Ethernet/IP communication protocols provide easy integration of sensor diagnostics tools into process control systems, minimum commissioning time and engineering support, saves the integration efforts and costs. Pure digital communication within loop and real-time measurements, sensor diagnostics and monitoring provides greater process reliability, lower maintenance costs.

**Profinet and Ethernet/IP Specifications**

Data transmission rate	10–100 MBd
Connector	RJ45, M12 optional
IP address	DHCP(default) or configuration via menu

### M800 Parameter Fit Guide for 2-/4-channel, 1-/2-channel Profinet, 1-/2-channel Ethernet/IP versions

These versions are compatible with the following (digital) ISM sensors.

	Process					
	2-channel <sup>1)</sup>	4-channel <sup>1)</sup>	1-channel Profinet	2-channel Profinet	1-channel Ethernet/IP	2-channel Ethernet/IP
pH/ORP	•	•	•	•	•	•
pH/pNa	•	•	•	•	•	•
UniCond 2-e/4-e	•	•	•	•	•	•
Conductivity 4-e	•	•	•	•	•	•
Amp. DO ppm/ppb/trace	•/•/• <sup>2)</sup>	•/•/• <sup>2)</sup>	•/•/• <sup>2)</sup>	•/•/• <sup>2)</sup>	•/•/• <sup>2)</sup>	•/•/• <sup>2)</sup>
Amp. O <sub>2</sub> gas ppm/ppb/trace	•/•/• <sup>2)</sup>	•/•/• <sup>2)</sup>	•/•/• <sup>2)</sup>	•/•/• <sup>2)</sup>	•/•/• <sup>2)</sup>	•/•/• <sup>2)</sup>
Opt. dissolved oxygen	• <sup>2), 3)</sup>	• <sup>2), 3)</sup>	• <sup>2), 3)</sup>	• <sup>2), 3)</sup>	• <sup>2), 3)</sup>	• <sup>2), 3)</sup>
Dissolved carbon dioxide (InPro 5000i)	•	•	•	•	•	•
CO <sub>2</sub> hi (InPro 5500i)	• <sup>3)</sup>	• <sup>3)</sup>	• <sup>3)</sup>	• <sup>3)</sup>	• <sup>3)</sup>	• <sup>3)</sup>
TOC/Dissolved ozone/Flow	-/-/-	-/-/-	-/-/-	-/-/-	-/-/-	-/-/-
Turbidity	-	-	•	• <sup>4)</sup>	•	• <sup>4)</sup>

1) Process 2-channel and 4-channel models are provided in polycarbonate or stainless steel housing.

2) Ingold sensors.

3) 2-channel: An opt. DO sensor or a CO<sub>2</sub> hi sensor has to be connected to channel 2. 4-channel: opt. DO sensors and CO<sub>2</sub> hi sensors have to be connected to channel 2 and/or to channel 4.

4) Turbidity sensor has to be connected to channel 2 for 2-channel Profinet and 2-channel Ethernet/IP models.

### M800 Parameter Fit Guide for 1-channel

This version is compatible with the following (digital) ISM and analog sensors.

	Process <sup>1)</sup>	
	Analog	ISM
pH/ORP	•	•
pH/pNa	-	•
UniCond 2-e/UniCond 4-e	-/-	•/•
Conductivity 2-e/Conductivity 4-e	•/•	-/•
Amp. dissolved oxygen ppm/ppb/trace	•/•/• <sup>2)</sup>	•/•/• <sup>2)</sup>
Amp. oxygen gas ppm/ppb/trace	•/•/• <sup>2)</sup>	•/•/• <sup>2)</sup>
Optical dissolved oxygen	-	• <sup>2)</sup>
Dissolved carbon dioxide (InPro 5000i)	-	•
CO <sub>2</sub> hi (InPro 5500i)	-	•
Turbidity	• (backscatter)	•

1) Process models are provided in polycarbonate or stainless steel housing or stainless steel housing. 2) Ingold sensors.

## Ordering Information

Transmitters	Order Number
M800 Process 1-channel	30 026 633
M800 Process 2-channel	52 121 813
M800 Process 4-channel	52 121 853
M800 1-channel, stainless steel enclosure	30 246 551
M800 2-channel, stainless steel enclosure	30 246 552
M800 4-channel, stainless steel enclosure	30 246 553
M800 Profinet 1-channel Process	30 530 021
M800 Profinet 2-channel Process	30 530 022
M800 Process 1-channel Ethernet/IP	30 530 023
M800 Process 2-channel Ethernet/IP	30 530 024

Installation Accessories	Order Number
Pipe mounting kit for ½ DIN	30 300 480
Panel mounting kit	52 500 213
Protective hood	30 073 328

## M800 parameter fit guide for 1-channel

This version is compatible with the following (digital) ISM and analog sensors.

Parameter	Process <sup>1)</sup>	
	Analog	ISM
pH/ORP	•	•
pH/pNa	–	•
UniCond 2-e/UniCond 4-e	–/–	•/•
Conductivity 2-e/Conductivity 4-e	•/•	–/•
Amp. dissolved oxygen ppm/ppb/trace	•/•/• <sup>2)</sup>	•/•/• <sup>2)</sup>
Amp. oxygen gas ppm/ppb/trace	•/•/• <sup>2)</sup>	•/•/• <sup>2)</sup>
Optical dissolved oxygen	–	• <sup>2)</sup>
Dissolved carbon dioxide (InPro 5000 i)	–	•
CO <sub>2</sub> hi (InPro 5500 i)	–	•
Turbidity	• (backscatter)	•

1) Process models are provided in polycarbonate or stainless steel housing or stainless steel housing. 2) Ingold sensors.

## Other Highlights

- Pure digital communication within loop and real-time sensor aging monitoring provides greater process reliability
- Easy integration of measurement and diagnostics data from the sensor up to the process control level
- Advanced diagnostic settings for efficient and reliable plant management

## M100 DIN Rail: High Performance and Minimal Space Requirement Compact Design for Simplified Installation



The M100 DIN Rail (DR) is a single-channel, 2-wire multi-parameter transmitter with HART communication capability for analytical measurements. It is compatible with ISM sensors for measuring pH/ORP, pH/pNa, oxygen and conductivity. The ISM's Plug and Measure feature minimizes the risk of installation troubles and simplifies sensor handling and LEDs clearly indicate transmitter and sensor status, alarms, and warnings.

Thanks to its compact design the M100 DR requires only a small installation space in the plant.

The transmitter configuration and integration of sensor diagnostics into asset management tools is possible thanks to the integrated HART protocol. The support of all major asset management tools ensures maximum compatibility and easy integration of sensor diagnostics.

### Specifications

#### General

Supply voltage	14 to 30VDC
Number of outputs	1 × 4 to 20 mA (loop powered)
Ambient temperature	- 10 to 60 °C (14 to 140 °F)
Relative humidity	0 to 95 % non-condensing
Enclosure rating	IP 20
Housing material	PA-FR
Hold input	Yes
Analog input	1 × 4 to 20 mA (for pressure compensation)
Communication	HART
Asset management tool compatibility	AMS versions 10, 11, 12, Simatic 6,8x, FDT frame applications

### Features Overview

- DIN rail mounting, suitable for 35 mm wide DIN rail systems
- Compact housing, 22.5 mm width
- Displayless
- Multi-parameter transmitter
- 1 analog output (4 to 20 mA with HART)
- HART communication as standard
- Configuration via HART handheld or other HART asset management tools

### ISM Highlights

- Plug and Measure functionality
- Dynamic Lifetime Indicator
- Adaptive Calibration Timer
- Time To Maintenance
- CIP/SIP/Autoclaving counter
- Easy installation and fast commissioning

► [www.mt.com/M100](http://www.mt.com/M100)



# M100 Sensor Mount Transmitter: Digital Sensor Integration for Analog and Digital Biocontrollers Smallest Footprint for Simplified Installation



The M100 Sensor Mount (SM) is a single-channel, multi-parameter transmitter. It allows the connection on biocontrollers of 1-wire ISM sensors for measuring pH, ampDO and CO<sub>2</sub> or ISM RS 485 optical oxygen sensors. The M100 SM has a Bluetooth 4.0 interface which is compatible with the PC-based and mobile versions of ISMCore software. Two independent interfaces are implemented: two configurable 4/20 mA analog outputs and one digital Modbus RTU. LEDs clearly indicate sensor status, alarms and warnings. ISM's Plug and Measure feature minimizes the risk of installation trouble and simplifies sensor handling.

### Specifications

ISM features	Plug and Measure, DLI, ACT, TTM
Enclosure	IP67
Mounting	On head of 1-wire sensor: AK9 On head of RS485 sensor: VP8
Supply voltage	24 VDC
Analog output	Active 2 × 4 to 20 mA, galvanically isolated to passive DCS card
Communication	Wireless: BT 4.0 ISMCore PC-based and iSense Mobile (Android, iOS) Wired: Digital interface RS485 Modbus RTU
Sensor compatibility	ISM 1-wire pH, amperometric DO and carbon dioxide sensors. ISM RS485 optical DO sensors

### Features Overview

- Configurable alarms
- Device naming
- Modbus communication
- ISM functionality
- Multi-parameter unit
- Configuration via ISM Core/iSense Mobile
- Process calibration with ISM Core/iSense Mobile or Modbus
- Color LED indication of sensor status
- Intuitive operation with ISM Core
- iMonitor

### Other Highlights

- CIP/SIP counter
- Dynamic Lifetime Indicator
- Adaptive Calibration Timer
- Easy installation
- Error-free operation:  
configuration stored in transmitter
- Electronic Data Management with ISM Core

## M80 Sensor Mount Transmitter

### ISM Solution for Benchtop Controllers

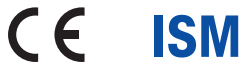

The M80 Sensor Mount (SM) Transmitter is a compact single-channel, multi-parameter transmitter designed especially for biocontroller manufacturers. Its small footprint allows mounting on ISM sensors used in benchtop bioreactors with a typical volume of 1–20 liters. A Modbus RTU interface enables straightforward and digital integration of sensor measurement data, ISM diagnostic information, and calibration routines into the biocontroller firmware. In addition, visualization of ISM features on the controller's graphical user interface becomes possible. The M80 SM is compatible with METTLER TOLEDO pH/ORP, amperometric dissolved oxygen, dissolved CO<sub>2</sub>, and conductivity sensors.

#### Specifications

ISM	Plug and Measure, DLI, ACT, TTM
Power supply	24 VDC (min. 100 mA), 8–30 VDC (min. 2 W)
Operating temperature	–15 to +60 °C (5 to 140 °F)
Relative humidity	5 ... 95 % rH (non-condensing)
Mounting	AK9 connector on head of 1-wire sensor
Cable connection	M12/5-pin for RS485 interface and power supply
Communication	Modbus RTU protocol
Dimensions	Height: 94 mm (3.7"), Maximum diameter: 22 mm (0.87")
Protection class	IP65

#### Features Overview

- Small footprint on bioreactor head plate
- Enables ISM functionality in biocontroller software
- Access to sensor calibration routines via the biocontroller
- No sensor configuration necessary due to internal storage of installation point specific data (Modbus parameters)
- Trouble-free sensor integration thanks to Plug and Measure
- Configurable with M80 SM Transmitter Configuration Tool PC software and Transmitter Configuration Box

#### Other Highlights

- Robust digital sensor integration
- Ideal for ISM solutions in R&D environment and down-scaling applications
- Pre-batch sensor diagnostics for more robust processes
- Enables electronic traceability of sensors used in different batches
- Less electronic waste compared to pH sensors with permanently integrated transmitter electronics



### Parameter Fit Guide

Parameter	M100 DR	M100 SM 1-wire	M100 SM RS485	M80 SM
pH/ORP	•	•	–	•
pH/pNa	•	•	–	–
Conductivity 4-e	•	–	–	•
Amp. DO ppm/ppb/trace	•/•/•	•/•/•	–	•/–/–
Opt. DO ppm	–	–	•	–
Amp. O <sub>2</sub> gas ppm	–	–	–	–
Dissolved carbon dioxide	–	•	–	•

### Ordering Information

Transmitter	Order Number
M100 DR/2H, 1-channel multi-parameter	30 127 720
M100 SM, 1-wire	30 365 366
M100 SM, RS485	30 365 367
M80 SM Transmitter	30 530 566

Accessories	Order Number
License ISM Core Essential	30 846 306
License ISM Core Advanced	30 846 307
License ISM Core CFR	30 846 348
iSense BT Dongle	30 371 387
iLink Multi	30 130 631
iLink Multi cable/set oDO (RS485)	30 355 582
M100SM adapter and power supply	30 404 002
CalBox (upgraded with temperature sensor)	52 300 400
Transmitter Configuration Box (cable set included) (M80)	30 530 567
5-pin data cable 2 m (6.6 ft)	52 300 379
5-pin data cable 5 m (16.4 ft)	52 300 380
5-pin data cable 10 m (32.8 ft)	52 300 381

## M400 2(X)H Type 2 and Type 3: Easy to Use and Robust For Harsh and Hazardous Areas



### Other Highlights

- **Easy Operation – Less Training Needed**

It provides with intuitive multi-language (10 languages) interface with readable display under all light conditions. The ISM Plug and Measure feature allows measurement readiness within seconds and enables error-free sensor installation.

- **Robust Design for Tough Environments**

The aluminum housing, anti-corrosive coating and stainless steel nuts are designed for harsh environments and hazardous area use. Extensive global approvals (CE, ATEX, IECEx, UKCA, FM, CSA, NEPSI, JPEX, KCs) ensure suitability for harsh and hazardous areas.

The M400 2(X)H Type 2 and Type 3 is a 2-wire, single-channel, multi-parameter process transmitter designed specifically for applications in hazardous or safe areas.

M400 2(X)H Type 2 and Type 3 has an advanced interface that is simple to operate. The large, dot matrix display ensures readability under all light conditions. Local or remote access via HART™ technology provides easy access to ISM sensor and diagnostic tools data. With its durable aluminum die-cast housing, anti-corrosive coating, stainless steel nuts and extensive certificates and approvals, it is suitable for implementation in the chemical, petrochemical, and pharmaceutical industries.

### Specifications

#### General

Display	4.4-inch TFT LCD Backlight
Languages	10 (English, German, French, Italian, Spanish, Portuguese, Russian, Japanese, Korean, and Chinese)
Ambient temperature	-20 to 60 °C (-4 to 140 °F)
Relative humidity	0 to 95 % non-condensing
Enclosure rating	IP 66/NEMA 4X
Housing material	Aluminum die cast housing with anticorrosive coating

#### Certificates and Approvals

CE, ATEX, IECEx, UKCA, FM, CSA, NEPSI, JPEX, KCs

- M400 2H (ISM) Type 2:**
- cCSAus/FM Class I, Division 2, Groups A, B, C, D T4A
  - cCSAus/FM Class I, Zone 2, Groups IIC T4

- M4002XH (ISM) Type 2 and Type 3:**
- ATEX/IECEx Zone 1 Ex ib [Ia Ga] IIC T4 Gb
  - ATEX / IECEx Zone 21 Ex ib [Ia Da] IIIC T80 °C Db IP 66
  - cCSAus/FM Class I, Division 1, Groups A, B, C, D T4A
  - cCSAus/FM Class II, Division 1, Groups E, F, G
  - cCSAus/FM Class III
  - cCSAus/FM Class I, Zone 0, AEx ia IIC T4 Ga

PID process controller	Yes
Analog input	4 to 20 mA (for pressure compensation)
<b>4 to 20 mA with HART</b>	
Power voltage	14 to 30VDC
Number of outputs	2 × 4 to 20mA (loop powered)
Hold input	Yes
Alarm contact	Yes (alarm delay 0 to 999 s)
Asset management tool compatibility	AMS versions 10 and 11, Simatic PDM version 6, or higher versions compatibility

► [www.mt.com/M400-2wire](http://www.mt.com/M400-2wire)

**Parameter Specifications****pH, pH/pNa and ISFET Performance**

Measurement parameters	pH, mV, and temperature
pH, ORP input range*	-1500 to 1500 mV
pH display range	-2 to 16 pH
Resolution	0.001/0.01/0.1/1 (can be selected)
Relative accuracy	±0.02 pH; ±1 mV
Temperature input	Pt 1000, Pt 100, NTC 22 kΩ
Temperature compensation	Automatic/manual
Temperature measuring range	-30 to 130 °C (-22 to 266 °F)
Temperature resolution	0.001/0.01/0.1/1 °C/°F (can be selected)
Temperature measurement error*	±0.25 °C (±0.45 °F)
Max. length sensor cable	analog: 20 m (65 ft), depending on sensor; ISM 80 m (260 ft)
Calibration	1 or 2 point calibration, process calibration

\* For analog input signal (ISM input signal causes no additional error)

**Oxygen Performance**

Measurement parameters	- Dissolved oxygen: Saturation or concentration and temperature - Oxygen in gas: Concentration and temperature
Current range	0 to 7000 nA
Oxygen measuring ranges	- Dissolved oxygen: Saturation 0 to 500 % air, 0 to 200 % O <sub>2</sub> Concentration 0.1 ppb (µg/L) to 50.00 ppm (mg/L) - In gas: 0 to 9999 ppm O <sub>2</sub> gas, 0 to 100 Vol-% O <sub>2</sub>
Oxygen accuracy*	±0.5 % of the measured value or ±0.5 % air, whichever is greater.
- Dissolved oxygen saturation	Concentration at high values: ±0.5 % of the measured value or ±0.050 ppm/±0.050 mg/L, whichever is greater. Concentration at low values: ±0.5 % of the measured value or ±0.001 ppm/±0.001 mg/L, whichever is greater.
- In gas:	±0.5 % of the measured value or ±5 ppb, whichever is greater for ppm O <sub>2</sub> gas. ±0.5 % of the measured value or ±0.01 %, whichever is greater for Vol-% O <sub>2</sub> .
Resolution current	6 pA
Polarization voltage	- 1000 to 0 mV for analog sensors - 550 mV or - 674 for ISM sensors (configurable)
Temperature input	Pt 1000
Temperature compensation	Automatic
Temperature measuring range	-30 to 150 °C (-22 to 302 °F)
Temperature accuracy*	±0.25 K in the range of -10 to +80 °C (14 to +176 °F)
Max. length sensor cable	analog: 20 m (65 ft); ISM 80 m (260 ft)
Calibration	1-point (slope or offset) calibration, process calibration (slope or offset) calibration

\* For analog input signal (ISM input signal causes no additional error)

**Conductivity Performance**

Measurement parameters	Conductivity, and temperature
Conductivity ranges (2-e/4-e)	2-electrode sensor: 0.02 to 2000 µS/cm (500 Ω × cm to 50 MΩ × cm) 4-electrode sensor: 0.01 to 650 mS/cm (1.54 Ω × cm to 0.1 MΩ × cm)
Temperature input	Pt 1000
Temperature measuring range	-40 to 200 °C (-40 to 392 °F)
Max. length sensor cable	60 m (196.9 ft) with 2-electrode sensor, 15 m (50 ft) with 4-electrode sensor 80 m (260 ft) with ISM sensor
Cond/Res accuracy*	±0.5 % of reading or 0.25 Ω, whichever is greater, up to 18 MΩ × cm
Cond/Res repeatability*	±0.25 % of reading or 0.25 Ω, whichever is greater
Cond/Res resolution	0.001/0.01/0.1/1 (can be selected)
Temperature resolution	0.001/0.01/0.1/1 °C/°F (can be selected)
Temperature accuracy*	±0.25 °C (±0.45 °F)
Temperature repeatability*	±0.13 °C (±0.23 °F)
Chemical concentration curves	NaCl, NaOH, HCl, HNO <sub>3</sub> , H <sub>2</sub> SO <sub>4</sub> , H <sub>3</sub> PO <sub>4</sub> User-defined concentration table (5 × 5 matrix) TDS ranges NaCl, CaCO <sub>3</sub>
Calibration	1 or 2 point calibration, process calibration

\* For analog input signal (ISM input signal causes no additional error)

## Parameter Specifications (continued)

### Optical Oxygen Performance

Measurement parameters	DO saturation or concentration and temperature
DO saturation range	0 to 500%, 0 to 100% O <sub>2</sub>
DO resolution	Auto/0.001/0.01/0.1/1 (can be selected)
DO accuracy	± 1 digit
Temperature resolution	Auto/0.001/0.01/0.1/1 °C (°F) (can be selected)
Temperature accuracy	± 1 digit
Temperature compensation	Automatic
Max. length sensor cable	15 m (50 ft)
Calibration	1 point (depending on sensor model), 2 point, process calibration

### Dissolved Carbon Dioxide Performance

Measurement parameters	Dissolved carbon dioxide and temperature
Dissolved carbon dioxide range	0 to 5000 mg/L, 0 to 200% sat, 0 to 1500 mmHg, 0 to 2000 mbar, 0 to 2000 hPa
mV range	-1500 to 1500 mV
Total pressure range	0 to 4000 mbar
Dissolved carbon dioxide accuracy	± 1 digit
Resolution	Auto/0.001/0.01/0.1/1 (can be selected)
Temperature range	-30 to 150 °C (-22 to 302 °F)
Temperature resolution	Auto/0.001/0.01/0.1/1 °C/°F (can be selected)
Temperature accuracy	± 1 digit
Temperature repeatability	± 1 digit
Max. length sensor cable	80 m (260 ft)
Calibration	1 or 2 point calibration, process calibration

### Inductive Conductivity (M400 Cond Ind transmitter only)

Measurement parameters	Conductivity and temperature
Display range	0 to 2,000 mS/cm
Chemical concentration curves	NaCl: 0-26% @ 0°C to 0-28% @ +100°C NaOH-1: 0-13% @ 0°C to 0-24% @ +100°C NaOH-3: 15-50% @ 0°C to 35-50% @ +100°C HCl-1: 0-18% @ -20°C to +50°C HCl-2: 22-39% @ -20°C to +50°C HNO <sub>3</sub> -1: 0-30% @ -20°C to +50°C HNO <sub>3</sub> -2: 35-96% @ -20°C to +50°C H <sub>2</sub> SO <sub>4</sub> -1: 0-26% @ -12°C to 0-37% @ +100°C H <sub>2</sub> SO <sub>4</sub> -2: 28-88% @ 0°C to 39-88% @ +95°C H <sub>2</sub> SO <sub>4</sub> -3: 94-99% @ -12°C to 89-99% @ +95°C H <sub>3</sub> PO <sub>4</sub> : 0-35% @ +5°C to +80°C User-defined concentration table (5 × 5 matrix)
TDS ranges	NaCl, CaCO <sub>3</sub>
Conductivity accuracy	± 1.0% of reading or ± 0.005 mS/cm
Conductivity repeatability	± 1.0% of reading or ± 0.005 mS/cm
Conductivity resolution	Auto/0.001/0.01/0.1/1 (can be selected)
Temperature input	PT1000/PT100/NTC22K
Temperature measuring range	-40 to +200 °C (-40 to +392 °F)
Temperature resolution	Auto/0.001/0.01/0.1/1 (can be selected)
Temperature accuracy	± 0.25 K (± 0.45 °F) within -30 to +150 °C (-22 to +302 °F); ± 0.50 K (± 0.90 °F) outside
Temperature repeatability	± 0.13 K (± 0.23 °F)
Max. sensor cable length	10 m (32.8 ft)
Calibration	1-point, zero point or process

**Transmitter Fit Guide**

Parameter	M400 2(X)H Type 2		M400 2XH Type 3	
	Analog	ISM	Analog	ISM
pH/ORP	•	•	•	•
pH/pNa (InPro 4850i)	–	•	–	•
Conductivity 2-e	•	–	•	–
Conductivity 4-e	•	•*	•	•*
Amp. DO ppm/ppb/trace*	•/•/•	•/•/•	•/•/•	•/•/•
High Performance DO ppb	•	•	•	•
Amp. DO Gas ppm/ppb/trace*	–	–	•/•/•	•/•/•
Optical oxygen ppm/ppb	–	•/•	–	•/•
Pure Water ODO ppb	–	•	–	•
Dissolved CO <sub>2</sub> (pharma InPro 5000i)*	–	•	–	•

\* Ingold sensors only

**Ordering Information**

Transmitter	Order Number
M400 2XH Type 2	30 655 901
M400 2H Type 2	30 655 902
M400 2XH Type 2 ISM	30 655 903
M400 2H Type 2 ISM	30 655 904
M400 2XH Type 3	30 655 905
M400 2XH Type 3 ISM	30 655 908

Accessories	Order Number
Pipe mounting kit for ½ DIN	30 300 480
Panel mounting kit for ½ DIN	30 300 481
Wall mounting kit for ½ DIN	30 300 482
Protective hood	30 073 328

**Other Highlights (cont. from p. 106)**

- **Flexible for Multiple Applications**

With its multi-parameter capability (pH, ORP, conductivity, dissolved oxygen, dissolved CO<sub>2</sub>, and gas-phase oxygen) and compatibility with both digital and analog sensors, it is suitable for a wide range of applications.

- **Universal Connectivity**

HART technology gives access to device information, measured values, ISM sensor diagnostics data, and allows use of remote calibration tools, DTM, and handheld field communicators.

# M400 2-Wire: 2XH Type 1, Cond Ind, PA and FF For Hazardous and Non-Hazardous Area Applications



### Features Overview

- NEPSI Ex/ATEX/FM approved
- Mixed-mode input (analog or ISM sensors accepted)
- Multi-parameter unit
- 4 to 20 mA (with HART) or Foundation Fieldbus version or PROFIBUS PA
- Compatible with ODO sensors
- IP 66/NEMA 4X rated

### Other Highlights

- Plug and Measure functionality
- CIP/SIP/Autoclaving counter
- Dynamic Lifetime Indicator
- Adaptive Calibration Timer
- Quick set up mode for fast installation

The M400 2-wire, single-channel, multi-parameter transmitter for pH/ORP, dissolved oxygen, gas phase oxygen, conductivity and dissolved carbon dioxide provides highest reliability and process safety in hazardous and non-hazardous area environments. Advanced ISM functionality enables predictive maintenance resulting in reduced operating costs and helps to improve productivity. The HART, Foundation Fieldbus (FF) or PROFIBUS PA interface provides easy integration of sensor diagnostics tools into process control systems.

### Specifications

#### General

Display	Backlit LCD, 4 lines
Languages	8 (English, German, French, Italian, Spanish, Portuguese, Russian and Japanese)
Ambient temperature	-20 to 60 °C (-4 to 140 °F)
Relative humidity	0 to 95 % non-condensing
Enclosure rating	IP 66/NEMA 4X
Housing material	Aluminum die cast

#### Certificates and Approvals

<b>M400/2XH:</b>	ATEX/IECEX Zone 1, FM cFus Cl.I Div.1 NEPSI Ex Zone 1, TIIS, KCS
<b>M400FF:</b>	ATEX/IECEX Zone 1, FM cFus Cl.I Div.1 NEPSI Ex Zone 1
<b>M400PA:</b>	ATEX/IECEX Zone 1, FM cFus Cl.I Div.1 NEPSI Ex Zone 1

PID process controller	Yes (except M400 PA/FF/2XH Type 1)
Analog input	Yes (except M400 2XH Cond Ind/2XH Type 1)

#### 4 to 20 mA with HART

Power voltage	14 to 30VDC
Number of outputs	2 x 4 to 20 mA (loop powered)
Hold input	Yes
Alarm contact	Yes (alarm delay 0 to 999 s)
Asset management tool compatibility	AMS versions 10 and 11, Simatic PDM version 6/8, FDT frame applications

#### Fieldbus Interface

Current	22 mA
Max. current in case of fault (FDE)	<28 mA
Number of current inputs	1 for pressure compensation
Supply voltage	<b>Non-hazardous area (Non-IS):</b> 9 to 32VDC <b>Linear Barrier:</b> 9 to 24VDC <b>FISCO:</b> 9 to 17.5VDC

#### PROFIBUS PA

Physical interface	According to ICE 61158-2
Profile	PROFIBUS PA 3.02
ITK version	6.0.1

#### Foundation Fieldbus

Profile	FF_H1
---------	-------

► [www.mt.com/M400-2XH](http://www.mt.com/M400-2XH)



## Parameter Specifications

For parameter specifications of M400 Type1, Cond Ind, FF and PA on pH, ORP, Conductivity, Dissolved Oxygen, Dissolved CO<sub>2</sub>, and Gas-Phase Oxygen please refer to page 107 – 108.

## Ordering Information

Transmitter	Order Number
M400/2XH 1-channel Cond Ind	30 256 307
M400 FF, 1-channel multi-parameter	30 026 616
M400 PA, 1-channel multi-parameter	30 026 617
M400/2XH Type 1, 1-channel multi-parameter	30 256 317

## Accessories

	Order Number
Pipe mounting kit for ½ DIN	30 300 480
Panel mounting kit for ½ DIN	52 500 213
Protective hood	52 500 214

## Transmitter Fit Guide

Parameter	M400/2XH	M400/2XH		M400FF		M400 PA	
	Cond Ind	Type 1		Analog	ISM	Analog	ISM
	Analog	Analog	ISM				
pH/ORP	–	•	•	•	•	•	•
Conductivity 2-e	–	•	–	•	–	•	–
Conductivity 4-e	–	•	–	•	•**	•	•**
Amp. DO* ppm/ppb/trace	–	–	–	•/•/•	•/•/•	•/•/•	•/•/•
Amp. O <sub>2</sub> gas	–	–	–	•	•	•	•
Optical oxygen ppm/ppb	–	–	–	–	•/•	–	•/•
Dissolved carbon dioxide (low)	–	–	–	–	•	–	•
Inductive conductivity	•	–	–	–	–	–	–

\* Ingold and Thornton sensors

\*\* Ingold sensors

## ISM Core

### Efficient and Safe Sensor Management

**ISM Core is METTLER TOLEDO's software for its Intelligent Sensor Management (ISM) technology. With ISM Core you can calibrate sensors in any convenient location, follow step-by-step animations that guide you through sensor calibration and maintenance, and easily generate electronic sensor documentation for regulatory purposes.**

#### **ISM Core Software Allows Quick, Safe and Easy Sensor Calibration Away From the Process**

ISM Core software makes calibration significantly quicker and easier. The step-by-step user guidance reduces training efforts to a minimum. ISM Core enables calibration in a laboratory or workshop - away from any challenging environments. Calibrated sensors can then be stored and quickly swapped back into the process whenever needed.

#### **ISM Sensors and Software Both Hold Full Sensor Maintenance History and Audit Trails**

Ensuring compliance with industry requirements is vital. ISM simplifies compliance because ISM sensors and ISM Core software hold a sensor's maintenance history. Calibration reports and audit trails can be generated to Excel or as PDFs. ISM ensures gapless and tamper-proof traceability of all calibrations, no matter whether the sensor was calibrated at the process or away from the process.



► [www.mt.com/ISM-Core](http://www.mt.com/ISM-Core)



**Calibration with ISM Core**

The ISM Core software enables convenient sensor calibration away from the process. The calibration concept is illustrated above.

1. Remove the sensor from the process and take it to your lab.
2. Clean the sensor. Connect the sensor to the ISM Core software and follow the calibration instructions. Calibration reports are generated automatically. Your sensor is now calibrated.
3. Insert your calibrated sensor to the process and reconnect it to the transmitter. ISM's Plug and Measure feature enables automatic transmitter configuration, allowing instant sensor use.

**ISM for Efficient Sensor Management**

With ISM, maintenance and management of your sensors is quick, convenient, and easy.



## ISM Core Software

### Your Digital Sensor Expert



### ISMCore



ISM Core CFR is technically compliant with 21 CFR Part 11 and EudraLex Volume 4 Annex 11.

#### Features Overview

- Automatic PDF protocols with sensor registration/calibration/adjustments/deactivation
- Protocols of field calibration
- Full sensor history
- Database export for further analysis

#### Other Highlights

- Intuitive Windows™ interface
- Early detection of worn-out sensors
- Comprehensive, at a glance sensor status analysis

ISM Core offers a unique means to optimize the performance of pH electrodes, oxygen and carbon dioxide sensors for enhanced reliability and process safety. Simply connect your ISM sensor via USB or Bluetooth to your PC and get access to various intuitive analysis, calibration and documentation applications. Pre-calibrate your ISM sensor with the accuracy of lab conditions and assess the sensor state with real-time diagnostic information. This allows you to decide instantly whether to re-use or discard a sensor. Calibration information is collected, managed and analyzed efficiently and documented consistently to satisfy regulatory requirements.

#### Specifications

Performance	
Measurement parameters	<b>pH/ORP</b> all digital ISM sensors <b>Oxygen</b> all digital ISM sensors <b>CO<sub>2</sub></b> InPro 5000 i
Calibration	
Temperature calibration of pH sensors	Supported by all ISM Core versions 1-point
ORP calibration	1-point, process
DO calibration for amp. sensors	slope, offset, process slope, process offset
DO calibration for optical sensors	1-point, 2-point, process, scaling
CO <sub>2</sub> (InPro 5000 i) calibration	1-point, 2-point, process, scaling
Performance	
M100SM settings	Supported by All ISM Core versions
Measurements	All ISM Core versions
Automated electronic documentation	ISM Core Advanced and CFR
Sensor field calibration dataset	ISM Core Advanced and CFR
Sensor database	ISM Core Advanced and CFR
Database backup	ISM Core Advanced and CFR
Sensor diagnostics dashboard	ISM Core Advanced and CFR
CFR Compliance support	ISM Core CFR
Recommended PC requirements	
Processor	Intel Core/AMD Ryzen or similar
RAM	4 GB
Screen resolution	1280 × 1024 or higher
Hard disk	500MB available hard disk space
Operating system	Microsoft Windows 10 or later
Graphics Card	Microsoft DirectX compatible graphics board with 3D acceleration
Interface	USB and/or Bluetooth™ (depending on the accessory)

► [www.mt.com/ISM-Core](http://www.mt.com/ISM-Core)

## Ordering Information

Description	Order Number
License ISM Core Essential	30 846 306
License ISM Core Advanced	30 846 307
License ISM Core CFR	30 846 348

Accessories	Order Number
iLink Multi (with integrated barometer and hygrometer)	30 130 631
iLink Multi Cable/Set oDO (RS485) (required cable set for optical oxygen sensors connecting with iLink Multi)	30 355 582
AK9/ 1m/BNC-50 (required cable set for pH, CO <sub>2</sub> and amperometric oxygen sensors connecting with iLink Multi)	59 902 168
CalBox with temperature sensor for iLink Multi	52 300 400
iSense BT Dongle (wireless connection to M100 SM and J-Box BT)	30 371 387
Cable DS AK9-RJ12 (connects 1-wire sensors to ISMCore)	52 300 383
iLink RS485 VP	30 014 134
iLink RS485	52 300 399



**iLink Multi** is a universal device for connecting digital ISM sensors (1-wire; RS485) to a PC/laptop running ISMCore software. When calibrating an optical DO sensor with the iLink Multi, calibration parameters are captured automatically using the built-in, physical parameter sensors.



### Did You Know

iSense Mobile allows you to check sensor status or conduct calibrations from the convenience of your phone. Download is free at Google Play or iTunes.

► [www.mt.com/ism-accessories](http://www.mt.com/ism-accessories)

Learn more about ISM Core, iSense Mobile and its accessories.

## Verification Kits

### Simulating Sensors and Validating Transmitters



ISM



The pH, O<sub>2</sub> and the CO<sub>2</sub> Verification Kits are sets of five different service tools that allow the simulation of reading values of pH, O<sub>2</sub> and the CO<sub>2</sub> ISM sensors with predefined measuring values and errors (not changeable by the user). Each tool corresponds to a METTLER TOLEDO ISM sensor and delivers a complete set of data information. They can also be used for control of loop and transmitter settings, as control of the transmitter's temperature compensation and general troubleshooting. Each verification kit is provided with a certificate.

#### Specifications

##### ISM Verification Kits

ISM Simulator pH Kit	pH 4, pH 7, toggle, ERR1, ERR2
ISM Simulator O <sub>2</sub> (InPro 6850i) Kit	Zero, Air, toggle, ERR1, ERR2
ISM Simulator O <sub>2</sub> ppb (InPro 6900i/InPro 6950i) Kit	Zero, Air, toggle, ERR1, ERR2
ISM Simulator CO <sub>2</sub> (InPro 5000i) Kit	15 mbar, 950mbar, toggle, ERR1, ERR2
Optical O <sub>2</sub> (InPro 6860i, InPro 6870i, InPro 6960i, InPro 6970i, THO ODO) Simulator	Zero, Air 1, Air 2, toggle, ERR1, ERR2

##### pH Analog Verification Kits

pH Simulator 112	pH 4, pH 7, pH 9
VP Simulator	20 °C (Pt100 or Pt1000), 50 °C (Pt100 or Pt1000)

##### Certificates and Approvals

ISM pH	IECEX/ATEX Ex ia IIC T6/T5/T4/T3 Ga/Gb FM: IS/I,II,III/1/ABCDEFG/T6
Amperometric O <sub>2</sub>	IECEX/ATEX Ex ia IIC T6/T5/T4/T3 Ga/Gb IECEX/ATEX Ex ia IIIC T69 °C/T81 °C/T109 °C/ T161 °C Da/Db FM: IS/I,II,III/1/ABCDEFG/T6

##### Features Overview

- Tool for verification of a measuring system
- Service tool for quick checks
- Control of transmitter settings
- Troubleshooting

**Ordering Information**

ISM Verification Kits	Order Number
ISM Simulator pH Kit	52 300 410
ISM Simulator O <sub>2</sub> (InPro 6850 i) Kit	52 300 416
ISM Simulator O <sub>2</sub> ppb (InPro 6900 i) Kit	52 300 422
ISM Simulator O <sub>2</sub> Trace (InPro 6950 i) Kit	52 300 428
ISM Simulator CO <sub>2</sub> (InPro 5000 i) Kit	30 031 035
Optical O <sub>2</sub> (InPro 6860 i, InPro 6870 i, InPro 6960 i, InPro 6970 i, THO ODO) Simulator	30 404 694

pH Analog Verification Kits	Order Number
pH Simulator 112	59 906 431
VP Simulator	52 120 939



**Did You Know**

The ISM pH, oxygen and CO<sub>2</sub> service tools are unique products that can control and verify loop and transmitter settings. The simulators generate a comprehensive data-set of non-modifiable ISM parameters.



Optical O<sub>2</sub> Simulator



pH Analog Verification Kits: Combining the pH simulator 112 ① with the VP simulator ② both pH and Temperature signals can be simulated to check the automatic temperature compensation capability of the transmitter.

## Process Connection Hardware Solutions for Every Challenge

METTLER TOLEDO Ingold offers a comprehensive line of products to connect to all common process environments – open basins, pipes, closed tanks, chemical reactors, bioreactors, and fermentation vessels. Depending upon the application, each connection type can have specific requirements for strength, safety, cleanliness, optimized performance, corrosion resistance, insertion depth, or physical space. Process connection hardware ranges from simple drop-in immersion fittings to complex automated systems capable of cleaning and calibrating your measuring equipment. The choice is yours! METTLER TOLEDO Ingold and your local representatives have worked extensively with a wide variety of process environments and can assist you in selecting the best hardware for your application.

The primary considerations when selecting a housing are:

1. Stationary or retractable housing
2. Connection entry: top-entry, side-entry, etc. (see illustration)
3. Connection style: cap nut, threaded NPT, etc.
4. Diameter of connection hole (bore size)
5. Insertion length
6. Wetted part materials: stainless steel, PVC, etc.
7. Process seal material (O-rings/gaskets)

This section has been organized according to the seven requirements listed above. To simplify selection, first decide if you prefer stationary,

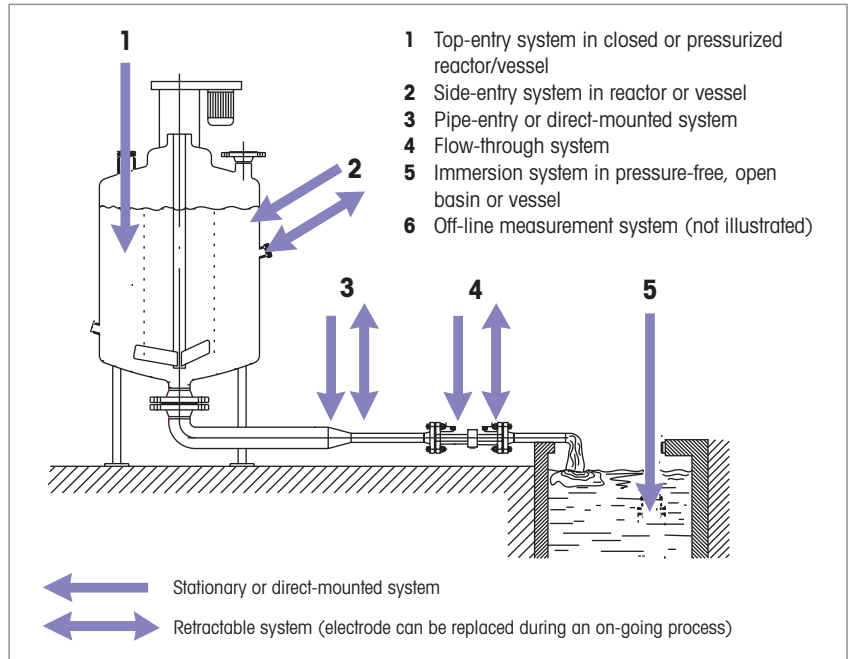

Common Entry/Style	Threaded Cap Nut	Threaded NPT	ANSI/DIN Flange	Ladish (Tri-Clamp)	Tuchenhagen/Varivent
1 Top-Entry	•	•	•	•	–
2 Side-Entry	•	•	•	•	•
3 Pipe-Entry	•	•	•	–	–
4 Flow-Through	•	•	•	–	–
5 Immersion	–	–	–	–	–

Common Wetted Parts	Key	Common O-rings	Key
Stainless Steel 316L	SS 316L	EPDM FDA Listed	EP
Stainless Steel 316L with Electropolish	SS E-P	EPDM Peroxide Cured	EP-pc
Stainless Steel 316L with Machined Surface	R <sub>a</sub> XX	Kalrez® FDA Listed USP Class VI	Ka-FDA-USP VI
Hastelloy	HA-C22	Silicone FDA Listed USP Class VI	Si-FDA-USP VI
Titanium	Ti	Silicone Peroxide Cured	Si-pc
PVC	PVC	PTFE/PTFE Coated*	N/A
PVDF	PVDF	Viton® FDA Listed	Vi
PTFE	PTFE	* As tested PTFE materials failed to provide acceptable elastomeric sealing and are not recommended.	

retractable, or flow through design and turn to the corresponding section that follows. A variety of different housings are available in each section

to meet your specific entry-type, connection style, and other requirements.



### The Ingold Socket and Safety Socket

Recognizing the need for a strong, sanitary, and safe process connection, Ingold engineered a socket to exceed the requirements found in the most demanding process environments.



When used with an appropriate housing, the Ingold Safety Socket allows the housing O-ring to break its seal while the cap nut retains a safe thread engagement. (See diagram below).



#### Retractable housings:

- **Secure**
- **Self-cleaning**
- **Process-independent**
- **Manual or automated**
- **Insertion lock without sensor**
- **For use in hazardous areas (ATEX, FM certificates)**

### Ingold housings

The hardware used to connect your analytical system to your process is now more important than ever and can actually improve your overall operating efficiency.

Retractable housings, first pioneered by METTLER TOLEDO Ingold, have now evolved into highly-sophisticated components which are process-independent, making sensor maintenance possible at any time without interrupting your process. Pneumatically operated housings insert and retract sensors automatically and form the cornerstone of a fully autonomous analytical system, capable of unattended cleaning and calibration. With an automated system your highly-skilled maintenance staff is able to focus on critical maintenance and repair projects rather than cleaning and calibrating sensors, raising the efficiency and productivity of your operation. For more information on automated maintenance systems, see page 140.

Stationary housings are widely used in all industries, providing a secure, durable, and safe way to position sensing devices in a process. Once connected, however, the stationary housing and sensor must be left in place until the process stops or flow is interrupted and the tank/pipe is drained.



### Wide range of process connections

Only a representative sample of Ingold's extensive process connection products are included in this catalog. Please refer to the METTLER TOLEDO product literature for more information.



### Don't see exactly what you need?

METTLER TOLEDO Ingold has more than 50 years of experience engineering specialized components or altering existing products to meet specific project requirements. Whether your need is for process resistant metals, special finishes, or modified dimensions, challenge us – chances are we have already designed what you need.



### Looking for a non-standard connection?

A growing number of projects co-locate redundant production facilities around the globe, occasionally standardizing process connections. METTLER TOLEDO Ingold is an international company, working with clients world-wide to equip state-of-the-art processing facilities with liquid analytical systems. If your project requires special process connections, we can help.

## Sockets, Flanges, and Plugs

### Reliable Adaption to the Process

#### Weld-in Sockets and Flanges



#### Ingold Socket and Safety Socket (DN25 and DN25/S)

The new safety weld-in sockets provide increased protection in the event of any premature attempt to remove the housing when the reactor or pipe is still under pressure or filled with medium. The socket is designed to prevent possible injury, damage or loss of medium. The Ingold Safety Socket is EHEDG approved.

#### Safety Feature:

- InFit 761-NC
- InFit 764-50-NC
- InPro 68xx

#### No Safety Feature:

- All previous types of housings or 25 mm DO sensors can be used, but without the benefit of the safety feature.

#### Specifications

Wetted Parts	Finish	Pressure Rating
Stainless 316L	N6/R <sub>o</sub> 32 (R <sub>o</sub> = 0.8 μm/32 μin)	16 bar (232 psi)

#### Screw-in Sockets



Primarily used for 19 mm vessel and pipe mounting applications.

#### Specifications

Wetted Parts	Finish
Stainless 316L	N6/R <sub>o</sub> 32 (R <sub>o</sub> = 0.8 μm/32 μin)

#### Blind Plugs



Manufactured to exacting standards to seal unused weld-in sockets and ports during cleaning and general operation.

#### Specifications

Wetted Parts	Finish
Stainless 316L	N6/R <sub>o</sub> 32 (R <sub>o</sub> = 0.8 μm/32 μin)

## Ordering Information

<b>Ingold Sockets</b>	<b>Bore Size</b>	<b>Insertion Length</b>	<b>Angle</b>	<b>Order Number</b>
Ingold socket, weld-in	25 mm	40 mm	15°	59 901 124
Ingold socket, weld-in	25 mm	40 mm	0°	59 901 127
Ingold socket, weld-in	25 mm	48 mm	15°	59 901 125
Ingold socket, weld-in	25 mm	50 mm	0°	59 901 128
Ingold socket, weld-in	25 mm	55 mm	15°	59 901 126
Ingold socket, weld-in	25 mm	60 mm	0°	59 901 129
OPTIONS: R <sub>a</sub> finish, electro-polish, non-reactive materials, other				Contact METTLER TOLEDO

<b>Ingold Safety Sockets</b>	<b>Bore Size</b>	<b>Insertion Length</b>	<b>Angle</b>	<b>Order Number</b>
Ingold safety socket, DN25/S weld-in	25 mm	40 mm	15°	52 400 462
Ingold safety socket, DN25/S weld-in	25 mm	47 mm	0°	52 400 518
OPTIONS: R <sub>a</sub> finish, electro-polish, non-reactive materials, other				Contact METTLER TOLEDO

<b>Screw-in Sockets</b>	<b>Bore Size</b>	<b>Insertion Length</b>	<b>Angle</b>	<b>Order Number</b>
Screw-in socket	19 mm	40 mm	0°	59 901 290

<b>Blind Plugs</b>	<b>Connect</b>	<b>Bore Size</b>	<b>Insertion Length</b>	<b>Wetted Parts</b>	<b>Order Number</b>
BSP socket plug, straight	2¾" BSP	25 mm	50 mm	Stainless 316L	59 900 903
Ingold socket plug, straight DN25	Ingold	19 mm	42 mm	Stainless 316L	59 901 294
Ingold socket plug, straight DN25	Ingold	25 mm	40 mm	Stainless 316L	59 901 287
Ingold socket plug, 15° DN25	Ingold	25 mm	40 mm	Stainless 316L	59 901 283
Ingold socket plug, 15° DN25	Ingold	25 mm	48 mm	Stainless 316L	59 901 284
Ingold socket plug, straight DN25	Ingold	25 mm	50 mm	Stainless 316L	59 901 288
Ingold socket plug, 15° DN25	Ingold	25 mm	55 mm	Stainless 316L	59 901 285
Ingold socket plug, straight DN25	Ingold	25 mm	60 mm	Stainless 316L	59 901 289
OPTIONS: R <sub>a</sub> finish, electro-polish, non-reactive materials, O-rings, process connection, other					Contact METTLER TOLEDO

## InFit 761 e

### High Versatility with a Wide Selection of Process Connections



The InFit 761 e series housings are stationary housings for 12 mm sensors with a Pg 13.5 threaded collar. This is one of the most versatile housings in the Ingold product line due to the wide availability of materials, O-rings, process connections, and insertion lengths. Rugged plastic (PVDF, PP), stainless steel, and Hastelloy (optional) versions stand up to harsh and demanding environments encountered in industrial processing and industrial wastewater applications. For extreme hygienic requirements, the InFit 761 e is available in 316L stainless steel configurations (EHEDG and 3A compliant), and also with N5/R<sub>0</sub> 16 surface finishes to meet the most stringent regulatory guidelines.

#### Specifications

	InFit 761 e, Steel Version	InFit 761 e, Plastic Version
Wetted parts	Stainless 316L	PVDF, PP
Surface finish (O-ring groove/Other)	Hygienic: (<R <sub>0</sub> 0.38 μm/ R <sub>0</sub> 15 μin)* + electropolished Others: R <sub>0</sub> 0.4 μm/R <sub>0</sub> 16 μin	R <sub>0</sub> 0.8 μm/R <sub>0</sub> 32 μin
O-ring***	Silicone-FDA-USP VI	Viton®-FDA
Sensor fitting	Pg 13.5	Pg 13.5
Temperature range	0–140°C/32–284°F	0–100°C/32–212°F
Pressure rating (Sensor dependent)	Max. 16 bar/232 psig	Max. 6 bar/87 psig**
<b>Certificates and Approvals</b>	EHEDG and 3A compliant (CIP shaft only) ATEX/FM certificates (metallic version only): Pressure Equipment Directive guidelines (PED) and CE	

\* Not with protective cage

\*\* Temperature dependent

\*\*\* Other O-ring material see technical document

Many housing options are available. Please use the product configurator and sensor fit guide found on p. 129.

#### Other Highlights

- Simple, yet highly durable
- Easy-to-use and low maintenance

#### Features Overview

- Models with sensor holder type "C" integrate with the Ingold safety socket to prevent injury or damage
- Many options for corrosion-resistant materials, O-rings, and process connections
- Surface finish N5/R<sub>0</sub> 16 (excluding version with protective cage)

#### Suggested Sensors

pH	DO	CO <sub>2</sub>	Conductivity	Turbidity
InPro 3030	InPro 6050	InPro 5000 (i)	InPro 7001	InPro 8050
InPro 3100 (i)	InPro 6800 (G)		InPro 7100 (i)	InPro 8100
InPro 3250 (i)	InPro 6850 (i) (G)			InPro 8200
InPro 4010	InPro 6900 (i) (G)			
InPro 4260 (i)/4281 i	InPro 6950 (i) (G)			
InPro 4800 (i)/4881 i	InPro 6860 i*/6970 i*			
DPAS, DPA				
DXK				

\* special Retrofit Kit required

# InFit 761 e

## O-Ring Groove

The InFit 761 e housings are available in mainly three different O-ring groove type configurations, consisting of the selected protective cage and sensor fitting:

- **NS / WS** Standard squared O-ring groove with or without cage
- **NC** CIP round O-ring groove without cage
- **WK** Standard squared O-ring groove with NPT shaft and cage

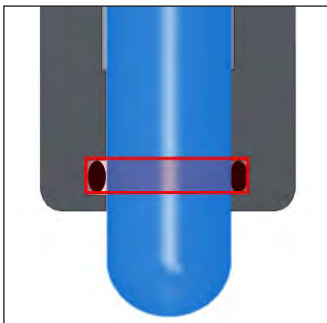

### Standard O-ring groove

- Standard square style O-ring groove
- Non-hygienic design
- Available with or without protective cage
- Machined surface finish Ra >0.4 µm / 15 µin

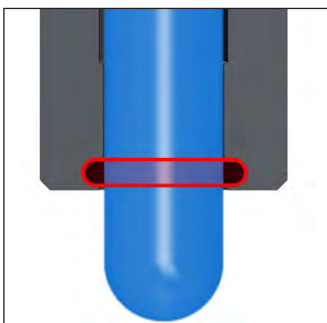

### CIP O-ring groove

- CIP round style O-ring groove
- Hygienic design for better sanitization control
- Available without protective cage only
- Electropolished surface when in 1.4435/316L
- Surface roughness Ra <0.4 µm / 15 µin



### Process Adaptions for Food & Beverage

With DIN 11851 DN40 and SMS 1147 DN38 and DN51 are new Process Adaptions available for InFit761. Together with InPro X1 EHEDG and 3A certifications are valid for InFit 761 with DIN11851 process adapters (use of Siersema special process sealing required).

## InFit 762 e/763 e

### The Solution for Top-Entry into Large Vessels



InFit 762 e

InFit 763 e



#### Other Highlight

- Certificates of compliance are available upon request, including certificate of inspection 3.1

► [www.mt.com/InFit762](http://www.mt.com/InFit762)

► [www.mt.com/InFit763](http://www.mt.com/InFit763)

The InFit 762 e and InFit 763 e stationary housings are designed for top mount applications in larger vessels and reactors. An optional protective cage may be ordered separately. The static insertion housing InFit 762 e allows quick and easy installation of electrodes and sensors with Pg 13.5 thread. This allows the use of a large range of pH/redox electrodes with solid or gel-type reference electrolyte as well as sensors for measuring conductivity, turbidity, dissolved oxygen and CO<sub>2</sub>. The static insertion housing InFit 763 e provides quick and easy integration of pressurized pH/redox electrodes with liquid and refillable reference electrolyte. The InFit 763 e (PVDF version) housing is specifically designed for applications where tank damage is of concern – especially glass-lined reactors. The InFit 763 e (PVDF version) housing connects to the process using a variety of available flanges; however, a PN16 (AISI 150) flange is specified most often. A protective cage protects the electrode against abrasive solids in the process medium. The InFit 763 e (PVDF version) is designed for use where stainless steel is unsuitable and/or if the reactor is lined with rubber or glass.

#### Specifications

	InFit 762 e/763 e, Steel Version	InFit 763 e, Plastic Version
Wetted parts	Stainless 316 L/C22/Ti	PVDF
Surface finish (O-ring groove/Other)	N6/N8 (R <sub>a</sub> 32/R <sub>a</sub> 125)	N6/N8 (R <sub>a</sub> 32/R <sub>a</sub> 125)
O-ring**	Viton®-FDA	Viton®-FDA
Sensor fitting	762 e: Pg 13.5 763 e: InPro 2000	InPro 2000/Pg 13.5 (opt.)
Temperature range	0 – 130 °C/32 – 266 °F	0 – 130 °C/32 – 266 °F
Pressure rating (Sensor dependent)	0 – 6 bar/0 – 87 psig	0 – 10 bar/0 – 145 psig*

**Certificates** ATEX/FM certificates (metallic version only):

**and Approvals** Pressure Equipment Directive guidelines (PED) and CE

\* Temperature dependent

\*\* Other O-ring material see technical documentation

#### Suggested Sensors

	pH	DO	CO <sub>2</sub>	Conductivity	Turbidity
<b>InFit 762 e</b>	InPro 3030 InPro 3100 (i) InPro 3250 (i) InPro 4260 (i) InPro 4800 (i) DPAS, DPA DXK	InPro 6050 InPro 6800 (G) InPro 6850 (i) (G) InPro 6900 (i) (G) InPro 6950 (i) (G)	N/A	InPro 7001 InPro 7100 (i)	InPro 8050 InPro 8100 InPro 8200
<b>InFit 763 e</b>	InPro 2000 (i)	N/A	N/A	N/A	N/A

Many housing options are available. Please use the product configurator and sensor fit guide found on p. 130.

#### Features Overview

- Up to 4 m (13.1 ft) insertion length
- Rugged stainless steel or PVDF construction
- Extra long insertion lengths
- Uses cost-effective 120 mm/150 mm sensors

# InFit 764 e

## Problem Solver in Combination with Liquid-filled pH Electrodes



The InFit 764 e housings are specifically designed to maximize the performance and longevity of liquid-filled pH and redox sensors. The body of the housing can be pressurized to maintain a positive pressure differential between the sensor fill solution and the process. The positive differential eliminates sensor contamination by preventing process media from crossing the diaphragm into the sensor. A large inspection window makes it easy to monitor electrolyte level.

### Specifications

	InFit 764 e, Steel Version	InFit 764 e, Plastic Version
Wetted parts	Stainless 316L	PVDF
Surface finish (O-ring groove/Other)	N5/N5 (R <sub>a</sub> 16/R <sub>a</sub> 16) *	N6/N6 (R <sub>a</sub> 32/R <sub>a</sub> 32)
O-ring ***	Silicone-FDA-USP VI	Silicone-FDA-USP VI
Sensor fitting	Liquid-filled electrodes	Liquid-filled electrodes
Temperature range	0–130 °C/32–266 °F	0–110 °C/32–230 °F
Pressure rating (Sensor dependent)	0–6 bar/0–87 psig	0–6 bar/0–87 psig **

**Certificates** ATEX/FM certificates (metallic version only):

**and Approvals** Pressure Equipment Directive guidelines (PED) and CE

\* Not with protective cage

\*\* Temperature dependent

\*\*\* For other O-ring material see technical documentation

Many housing options are available. Please use the product configurator found on p. 129.

### Suggested Sensors

pH	DO	CO <sub>2</sub>	Conductivity	Turbidity
InPro 2000 (i)	N/A	N/A	N/A	N/A

### Sensor Fit Guide (for Liquid-Filled Electrodes)

Sensor Length	Insertion Length			
	70mm	100mm	150mm	200mm
120mm	•	–	–	–
150mm	–	•	–	–
200mm	–	–	•	–
250mm	–	–	–	•

The InFit 764 e housing is specifically designed for use with liquid-filled pH sensors. This sensor fit guide is designed to assist you with selecting the proper pH sensor. Other insertion lengths are available on request.

### Other Highlights

- 3A compliant (CIP shaft only)

### Features Overview

- Positive overpressure
- Large inspection window
- Sterilizable in situ
- Surface finish N5/R<sub>a</sub> 16 (excluding version with protective cage)





## InDip 550 Immersion Housing for Open Basin Installations



The InDip™ immersion housings are designed to provide a cost-effective, yet rugged process connection with the flexibility to meet the wide variety of installation requirements found in open tanks, reactors, aeration basins and open vessels.

### Specifications

InDip 550	
Wetted parts	PVC, PVDF
Surface finish (O-ring groove/Other)	N/A
O-ring	Viton®-FDA
Sensor fitting	Pg 13.5, 1" NPT, ¾" NPT, IND
Temperature range	0–60 °C/32–140 °F (PVC) 0–100 °C/32–212 °F (PVDF)
Pressure rating (Sensor dependent)	N/A

### Suggested Sensors

pH	DO	CO <sub>2</sub>	Conductivity	Turbidity
InPro 3030	InPro 6050	N/A	InPro 7001	InPro 8050
InPro 3100 (i)	InPro 6800 (G)		InPro 7108	InPro 8100
InPro 3250 (i)	InPro 6850 (i) (G)		InPro 7250	
InPro 4010	InPro 6900 (i) (G)		InPro 7100 (i)	
InPro 4260 (i)	InPro 6950 (i) (G)			
InPro 4501				
InPro 4800 (i)				
DPA				
DPAS				
DXK				

### Other Highlight

- Certificates of compliance are available upon request, including certificate of inspection 3.1

### Sensor Fit Guide

Sensor Length	Insertion Length
120 mm	User-defined (max. 3 m)

The InDip 550 is designed to accept all 120 mm sensors.

Many housing options are available. Please use the product configurator found on p. 131.



# InDip 508/510

## Versatile Immersion Housing for Wastewater Installations



The InDip™ 508/510 immersion housing is designed to withstand abrasive chemical applications. It is a cost-effective yet rugged process connection that is suitable for use in open tanks and vessels, reactors, and aeration basins.

### Specifications

Operation	Immersion
Sensors Accepted	pH & ORP, Dissolved oxygen, CO <sub>2</sub> , Conductivity, Turbidity
Accepted Sensor Length	120 mm
Insertion Length	User-defined (max. 3 m)
Wetted Parts	PVC/PVDF
O-Ring	FKM FDA
Sensor Fitting	Pg13.5
Temperature Range	0–130 °C/32–266 °F
Pressure Range	0 barg/0 psig

### Suggested Sensors

pH	DO	CO <sub>2</sub>	Conductivity	Turbidity
InPro 3030	InPro 6050	N/A	InPro 7001	InPro 8050
InPro 3100 (i)	InPro 6800 (G)		InPro 7108	InPro 8100
InPro 3250 (i)	InPro 6850 (i) (G)		InPro 7250	
InPro 4010	InPro 6900 (i) (G)		InPro 7100 (i)	
InPro 4260 (i)	InPro 6950 (i) (G)			
InPro 4501				
InPro 4800 (i)				
DPA				
DPAS				
DXK				

### Features Overview

- Watertight
- Wide range of installation options
- Optional floating adapter

### Ordering Information

	Connection Tube Thread	Wetted Material	Order Number
InDip 508 PVC	1" NPT	PVC	52 403 525
InDip 508 PVDF	1" NPT	PVDF	52 403 526
InDip 510 PVC	M32×1.5	PVC	30 899 171
InDip 510 PVDF	M32×1.5	PVDF	On request
Floating Adapter PVC InDip 508	1" NPT	PVC	30 881 028
Floating Adapter PVC InDip 510	M32×1.5	PVC	30 881 027

### Optional Floating Adapter

The optional floating adapter correctly levels out the sensor in pools and basins, always ensuring proper measurement. The floating adapter includes a connection tube that ensures an insertion length of 236 mm. For extended insertion length the connection tube must be sourced locally in the required length.



## InFlow Series Modular, Highly Adaptable Flow-Through Housings



InFlow 761



InFlow 762



InFlow 751

InFlow 76X flow-through housings from METTLER TOLEDO are designed to enable safe and reliable mounting of the InTrac and InFit series sensor housings directly into the process or in a bypass (pipe). These rugged flow-through housings are specially suited to the requirements of the process industry and can be easily and safely installed, allowing reliable measurement procedures.

InFlow 751 flow-through housings serve for the direct fitting of METTLER TOLEDO electrodes and sensors for the measurement of pH, ORP, dissolved oxygen, conductivity and turbidity, particularly in the field of industrial wastewater treatment. The housings protect electrodes/sensors against mechanical damage.

### Specifications

	InFlow 751, PVC Version	InFlow 751, PVDF Version
Wetted parts	PVC	PVDF
Surface finish	N/A	N/A
(O-ring groove/Other)		
O-ring	Viton®-FDA	Viton®-FDA
Sensor/housing fitting	Pg 13.5, 1" NPT, 3/4" NPT	Pg 13.5, 1" NPT, 3/4" NPT
Temperature range	0–60 °C/32–140 °F	0–100 °C/32–212 °F
Pressure rating	1 bar/60 °C (14.5 psi/140 °F)	1 bar/100 °C (14.5 psi/212 °F)
(Sensor dependent)	4 bar/45 °C (58 psi/113 °F)	4 bar/75 °C (58 psi/167 °F)

	InFlow 761	InFlow 762
Wetted parts	Stainless 316L	PVDF
Surface finish	N/A	N/A
(O-ring groove/Other)		
O-ring	N/A	Viton®-FDA*
Sensor/housing fitting	InTrac 7XX, InFit 76X	InTrac 7XX, InFit 76X
Temperature range	0–140 °C/32–284 °F	0–140 °C/32–284 °F
Pressure rating	16 bar/140 °C (232 psi/284 °F)	1 bar/140 °C (14.5 psi/284 °F)
(Sensor dependent)		6 bar/80 °C (87 psi/176 °F)

**Certificates and Approvals** CE, Pressure Equipment Directive guidelines (PED)

\* Version with Ingold DN25 socket

### Features Overview

- Correctly positions sensors in tight confines of narrow pipes and slip streams
- Wide variety of materials and process connections to accommodate common process environments
- Optimally designed for use with METTLER TOLEDO housings and sensors

### Suggested Sensors

pH	DO	CO <sub>2</sub>	Conductivity	Turbidity
465	InPro 6050	InPro 5000 (i)	InPro 7001	InPro 8050
InPro 2000 (i)	InPro 6800 (G)		InPro 7100 (i)	InPro 8100
InPro 3250 (i)	InPro 6850 (i) (G)			
InPro 4010	InPro 6900 (i) (G)			
InPro 4260 (i)	InPro 6950 (i) (G)			
InPro 4501				
InPro 4800				
DPA				
DXK				

### Sensor Fit Guide

Sensor Length	InFlow 751	InFlow 76X
120mm	•	•

1 See appropriate housing section

Many housing options are available. Please use the product configurator found on p. 131.

► [www.mt.com/InFlow](http://www.mt.com/InFlow)

## Product Configurators

### InFit 761 e housing: Sensor Fit Guide (for glass pH electrodes)

Sensor Length	Insertion Length								
	25 mm	33 mm	40 mm	70 mm	100 mm	150 mm	175 mm	275 mm	375 mm
120 mm	•	•	•	•	–	–	–	–	–
150 mm	–	–	–	–	•	–	–	–	–
200 mm	–	–	–	–	–	•	–	–	–
225 mm	–	–	–	–	–	–	•	–	–
325 mm	–	–	–	–	–	–	–	•	–
425 mm	–	–	–	–	–	–	–	–	•

The InFit 761 e housing is a universal housing for use with pH, DO, CO<sub>2</sub>, conductivity and turbidity sensors. When using glass electrodes, it is important not to expose too much glass beyond the end of the housing. This sensor fit guide is designed to assist you with selecting the proper glass pH sensor. Stainless steel sensors (DO, CO<sub>2</sub>, cond, turb) are more rigid and may extend farther beyond the end of the housing, but it is not recommended. Other insertion lengths are available on request.

### Product configurator for InFit 761e and InFit 764e – not all configurations are possible

	Sensor Type	Protective Cage	Sensor Fitting	Insertion Length in mm	Material Wetted Parts	Process Connection	O-ring Material	O-ring Position
Pharma	1 (pH/Redox electrodes, O <sub>2</sub> , CO <sub>2</sub> , turbidity and conductivity sensors with Pg 13.5 thread)	N (Sensor holder without protective)	C (25 mm CIP shaft without)	0025 0033 0040 0070 0175 0200 0275 0375	4435 (Electropolished) C22–	D00 (Ingold DN25 (20 mm Hexagon)) T01 (Tri-Clamp flange 1.5", straight) T02 (Tri-Clamp flange 2", straight) T03 (Tri-Clamp flange 1.5", inclined) T04 (Tri-Clamp flange 2", inclined)	Vi (FKM Viton® FDA) EP (EPDM FDA) Ka (FFKM Kalrez® 6230 FDA/USP Class VI)	9 (29 mm distance)
						D00 (Ingold DN25 (20 mm Hexagon)) V01 (Varivent flange DN50, straight) V02 (Varivent flange DN50,		
Food & Bev.	1 (pH/Redox electrodes, O <sub>2</sub> , CO <sub>2</sub> , turbidity and conductivity sensors with Pg 13.5 thread) 4 (pH/Redox electrodes with liquid electrolyte)	W (Sensor holder with protective cage)	S (25 mm shaft)	0070 0175 0200 0275 0375	4435 C22– Ti– PVDF	D10 ((Ingold DN25 (18 mm Hexagon)) D02 (flange DN32 PN16) D38 (SMS 1147 DN38) D40 (DIN 11851 DN40) D51 (SMS 1147 DN51) D03 (flange DN40 PN16) D04 (flange DN50 PN16) D06 (flange DN80 PN16) A02 (flange ANSI A150 – 1.5") A03 (flange ANSI A150 – 2") A04 (flange ANSI A150 – 3")	2 (22.4 mm distance)	
Chemical & Others			K (NPT shaft)	0040	4435 PVDF	N04 (NPT ¼")		
		<input type="checkbox"/>	<input type="checkbox"/>	<input type="checkbox"/>	<input type="checkbox"/> <input type="checkbox"/> <input type="checkbox"/> <input type="checkbox"/>	<input type="checkbox"/> <input type="checkbox"/> <input type="checkbox"/>	<input type="checkbox"/> <input type="checkbox"/>	<input type="checkbox"/>

# Stationary Housings

Flexible Multi-Parameter Control

Housings

## InFit 762 e/763 e housing: Sensor Fit Guide

Description	Sensor Length		Insertion Length	
	120 mm	150 mm	400 mm up to 4000 mm	
InFit 762 e (for sensors with Pg 13.5)	•	–	•	•
InFit 763 e (for liquid-filled pH only)	•	•	•	•
InFit 763 e (PVDF version)	• <sup>1</sup>	•	•	•

<sup>1</sup> with Pg 13.5 adapter

The InFit 762e housing is a universal housing for use with pH, DO, CO<sub>2</sub>, Conductivity and Turbidity Pg 13.5 sensors (InFit 763e for liquid-filled pH sensors). When using glass electrodes, it is important not to expose too much glass beyond the end of the housing. This sensor fit guide is designed to assist you with selecting the proper glass pH sensor.

## Product configurator for InFit 762e and InFit 763e – not all configurations are possible

	Sensor Type	Protective Cage	Sensor Holder	Insertion Length available in steps of 100 mm	Material Wetted Parts	Process Connection	O-ring Material
Pharma	2 (pH/Redox electrodes, O <sub>2</sub> , CO <sub>2</sub> , turbidity and conductivity sensors with Pg 13.5 thread)	N (Sensor holder without protective cage)	F (Turbidity Sensor)	0400 ... 4000	4435 C22–	B02 (DN50 G2" for ss version) T05 (Tri-Clamp 3" flange straight)	EP (EPDM FDA) Ka (FFKM Kalrez® 6230 FDA/USP Class VI) Vi (FKM Viton® FDA)
			G (12 mm electrodes with Pg 13.5)				
Food & Bev.	2 (pH/Redox electrodes, O <sub>2</sub> , CO <sub>2</sub> , turbidity and conductivity sensors with Pg 13.5 thread)	W (Sensor holder with protective cage)	G (12 mm electrodes with Pg 13.5)	0400 ... 4000	4404 C22– Ti –	T03 ((ANSI 2" / 150 lbs) A04 (ANSI 3" / 150 lbs) A05 (ANSI 4" / 150 lbs) D04 (Flange DN50 – PN16) D05 (Flange DN65 – PN16) D07 (Flange DN100 – PN16)	EP (EPDM FDA) Ka (FFKM Kalrez® 6230 FDA/USP Class VI) Vi (FKM Viton® FDA)
Chemical & Others			F (Turbidity Sensor)				
		3 (pH/Redox electrodes with liquid electrolyte)					
			H (Electrodes with liquid electrolyte; α = 120 mm)				

## Ordering Information for InDip 508/510

InFlow 751	Connection Tube Thread	Wetted Material	Order Number
InDip 508 PVC	1" NPT	PVC	52 403 525
InDip 508 PVDF	1" NPT	PVDF	52 403 526
InDip 510 PVC	M32×1.5	PVC	30 899 171
InDip 510 PVDF	M32×1.5	PVDF	On request
Floating Adapter PVC InDip 508	1" NPT	PVC	30 881 028
Floating Adapter PVC InDip 510	M32×1.5	PVC	30 881 027

## Ordering Information for InFlow 751

### InFlow 751

– PVC Version	Process Connect	Bore Size	Insert Length	Wetted Parts	Order Number
InFlow 751 d32DN25	Pg 13.5	32 mm	N/A	PVC	52 400 250
InFlow 751 d32DN25	NPT ¾"	32 mm	N/A	PVC	52 400 256
InFlow 751 d50DN40	Pg 13.5	50 mm	N/A	PVC	52 400 251
InFlow 751 d50DN40	NPT ¾"	50 mm	N/A	PVC	52 400 257
InFlow 751 d50DN40	NPT 1"	50 mm	N/A	PVC	52 400 644
InFlow 751 d63DN50	Pg 13.5	63 mm	N/A	PVC	52 400 252
InFlow 751 d63DN50	NPT ¾"	63 mm	N/A	PVC	52 400 258
InFlow 751 d63DN50	NPT 1"	63 mm	N/A	PVC	52 400 645
– PVDF Version					
InFlow 751 d32DN25	Pg 13.5	32 mm	N/A	PVDF	52 400 253
InFlow 751 d32DN25	NPT ¾"	32 mm	N/A	PVDF	52 400 259
InFlow 751 d50DN40	Pg 13.5	50 mm	N/A	PVDF	52 400 254
InFlow 751 d50DN40	NPT ¾"	50 mm	N/A	PVDF	52 400 260
InFlow 751 d50DN40	NPT 1"	50 mm	N/A	PVDF	52 400 646
InFlow 751 d63DN50	Pg 13.5	63 mm	N/A	PVDF	52 400 255
InFlow 751 d63DN50	NPT ¾"	63 mm	N/A	PVDF	52 400 261
InFlow 751 d63DN50	NPT 1"	63 mm	N/A	PVDF	52 400 647

For the housing configuration of the InFlow 76X, please use the product configurator below.

### Product configurator for InFlow 76X – not all configurations are possible

Material (others on request)															1.4404/316L PVDF (polyvinylidene fluoride)																			
1	/	4	4	0	4										Flow-through direction																			
2	/	P	V	D	F										1	8	0	180°																
															-	9	0	90°																
															Process connection*																			
															D	2	5	DIN flange DN25 PN16																
															D	5	0	DIN flange DN50 PN16																
															A	0	1	ANSI flange A150-1"																
															A	0	2	ANSI flange A150-2"																
															W	2	5	Welding connection DN25 (1")																
															W	5	0	Welding connection DN50 (2")																
															Housing connection*																			
															D	0	0	Ingold DN25																
															D	0	4	DIN flange DN50																
															Special																			
															-	Standard																		
															S	Special																		
InFlow 76		/																																
															9	10	11	12	13	14	15	16	17	18	19	20	21	22	23	24	25	26	27	28



### Seals

The InFlow 76X PVDF version with Ingold DN25 socket

is fitted with a medium-wetted O-ring made of Viton®. O-ring sets made of EPDM and Kalrez® are available as accessories.



### Important addition to the order information for InDip 550 housings

Flanges for the InDip 550 have to be ordered separately. They cannot be included to the part number of the housing. Local assembly of InDip housings is also possible. Ask your local METTLER TOLEDO representative.



### Did You Know

Measurement loops from METTLER TOLEDO can be automated with the EasyClean systems for rinsing, cleaning and calibrating. See pages 140–145 for more information.

### Product configurator for InDip 550 – not all configurations are possible

Insertion length (other lengths on request)				
1000 mm insertion length				
1500 mm insertion length				
2000 mm insertion length				
2500 mm insertion length				
3000 mm insertion length				
Material (wetted parts)				
PVC (Polyvinyl chloride)				
PVDF (Polyvinylidene fluoride)				
Sensor interface				
Pg 13.5 (with protective cage P or GP available)				
¾" NPT				
Cond 1" NPT				
IND (for InPro 7250)				
Protective cage				
P				
GP				
InDip 550	1000	PVC	Cond 1" NPT	-
	1500	PVDF	Pg 13.5	-
	2000	PVC	Pg 13.5	GP

## InTrac 776e For Liquid-Filled pH Electrodes



**USP  
Class VI**



The retractable InTrac 776e housings are designed for applications in processes which utilize pH/ORP sensors that have a liquid electrolyte reference system such as the InPro 2000 and Ingold 465 series electrodes. The housing has a built-in flushing chamber in which the electrode can be cleaned and calibrated if necessary, both accomplished without interruption of the process. This enhanced housing incorporates the Tri-Lock safety system which increases process safety and reliability even in harsh applications.

### Specifications

Operation	Manual or pneumatic	
Ambient temperature	Polypropylene:	0 to 70 °C (32 to 158 °F)
	Stainless steel:	- 10 to 70 °C (14 to 158 °F)
Functional pressure range	Manual:	0 to 5 bar (0 to 73 psig)
	Pneumatic:	0 to 6 bar (0 to 87 psig)
Max. permissible pressure	Polypropylene (PP):	6 bar at 20 °C (87 psig at 68 °F)
	PVDF, PEEK:	6 bar at 20 °C (87 psig at 68 °F)
	316 L stainless steel:	6 bar at 140 °C (87 psig at 276 °F)
	Hastelloy /Ti:	6 bar at 140 °C (87 psig at 276 °F)
Insertion lengths	70 mm, 100 mm, 200 mm (2.76", 3.94", 7.87")	
Wetted parts	316 L stainless steel, Hastelloy – C22, titanium, PP, PVDF, PEEK	
Wetted O-rings	Viton®-FDA, EPDM-FDA, Kalrez®-FDA-USP Class VI	
Housing length	70/100 mm:	545 mm (21.8") in process
		710 mm (28") retracted from process
	200 mm:	645 mm (25.4") in process 1110 mm (43.7") retracted from process
Pneumatic conditions	4 to 8 bar (58 to 116 psig)	
Flushing connections (water, steam)	2 to 6 bar (29 to 87 psig)	
Position monitoring (options)	Pneumatic check (3/2 way valve), G1/8"	
	Inductive check, non-Ex, M12 × 1	
	Inductive check, Ex, M12 × 1	

### Certificates and Approvals

CE;  
Pressure Equipment Directive guidelines (PED);  
Certificate of conformity according to EN10204-2.1;  
Material certificate according to 3.1;  
ATEX, FM and MaxCert

### Sensor Fit Guide (for Liquid-Filled Glass pH Electrodes)

Sensor Length	Insertion Length		
	70 mm	100 mm	200 mm
250 mm	•	•	–
450 mm	–	–	•

Many housing options are available. Please use the product configurator found on p. 137.



### Did You Know

Measurement loops from METTLER TOLEDO can be automated with the EasyClean systems for rinsing, cleaning and calibrating. See pages 140–145 for more information.

► [www.mt.com/InTrac776](http://www.mt.com/InTrac776)

# InTrac 777 e/779 e

## The Reliable All-Rounder



### Features Overview

- Advanced Tri-Lock safety system
- Remove sensor without interrupting of the process
- Automation with EasyClean

### Other Highlights

- Multiple process connections available
- For use with 12 mm Ingold sensors
- MaxCert covers necessary certifications
- Increased operational safety and reliability
- Several materials of construction available

▶ [www.mt.com/InTrac777](http://www.mt.com/InTrac777)

▶ [www.mt.com/InTrac779](http://www.mt.com/InTrac779)

The retractable InTrac 777 e/779 e housings are specifically designed for applications in processes which utilize 12 mm pH, ORP, dissolved oxygen, CO<sub>2</sub>, conductivity, and turbidity (InTrac 779e) sensors. The housing has a flushing chamber in which the electrode can be cleaned and calibrated if necessary, both accomplished without interruption of the process. This enhanced housing incorporates the Tri-Lock safety system which increases process safety and reliability even in harsh applications. Multiple process connections and materials of construction make the InTrac 777 e/779 e an excellent choice for use in either the chemical, biopharmaceutical or food and beverage industries.

### Specifications

Operation	Manual or pneumatic (295 mm version pneumatic only)
Ambient temperature	Polypropylene: 0 to 70 °C (32 to 158 °F) Stainless steel: – 10 to 70 °C (14 to 158 °F)
Functional pressure range	Manual: 0 to 5 bar (0 to 73 psig) Pneumatic: 0 to 16 bar (0 to 232 psig)
Max. permissible pressure	Polypropylene (PP): 6 bar / 20 °C (87 psig / 68 °F) PVDF, PEEK: 6 bar / 20 °C (87 psig / 68 °F) 316 L stainless steel: 16 bar / 140 °C (232 psig / 276 °F) Hastelloy / Ti: 16 bar / 140 °C (232 psig / 276 °F)
Insertion lengths	70 mm, 100 mm, 200 mm, 295 mm (2.76", 3.94", 7.87", 11.61")
Wetted parts	316 L stainless steel, Hastelloy-C22*, titanium, PP*, PVDF*, PEEK*, * not available for 295 mm version
Wetted O-rings	Viton®-FDA, EPDM-FDA, Kalrez®-FDA and USP Class VI
Housing length	70 / 100 mm: 360 mm (14.2") in process 515 mm (20.3") retracted from process 200 mm: 460 mm (18.1") in process 915 mm (36") retracted from process
Pneumatic conditions	4 to 8 bar (58 to 116 psig)
Flushing connections (water, steam)	2 to 6 bar (29 to 87 psig)
Position monitoring (options)	Pneumatic check (3/2 way valve), G 1/8" Inductive check, non-Ex, M12 × 1 Inductive check, Ex, M12 × 1
<b>Certificates and Approvals</b>	CE; Pressure Equipment Directive guidelines (PED); Certificate of conformity according to EN10204-2.1; Material certificate according to 3.1; ATEX, FM and MaxCert

Many housing options are available. Please use the product configurator and sensor fit guide found on p. 137.



### Did You Know

Measurement loops from METTLER TOLEDO can be automated with the EasyClean systems for rinsing, cleaning and calibrating. See pages 140–145 for more information.

## InTrac 797 e/799 e When Sterile Conditions Are Required



**USP**  
Class VI



### Features Overview

- Twin-chamber lock effectively prevents any external contamination
- Advanced Tri-Lock safety system
- Remove sensor without interrupting of the process

### Other Highlights

- Multiple process connections available
- For use with 12 mm Ingold sensors
- Double flushing chamber
- Increased operational safety and reliability

The retractable InTrac 797 e/799 e housings are specifically designed for applications in processes which utilize 12 mm pH, ORP, dissolved oxygen, CO<sub>2</sub>, conductivity, and turbidity (InTrac 799 e) sensors. This sterilizable housing has a double flushing chamber which was designed to meet the highest demands of the pharmaceutical and food and beverage industries where sterile conditions are required. The double flushing chamber allows complete sterilization of the upper and lower sections of a sensor and insertion shaft allowing the electrode/ sensor to be removed and replaced under a completely sterile environment.

### Specifications

Operation	Manual or pneumatic	
Ambient temperature	Stainless steel: – 10 to 70 °C (14 to 158 °F)	
Functional pressure range	Manual:	0 to 5 bar (0 to 73 psig)
	Pneumatic:	0 to 16 bar (0 to 232 psig)
Max. permissible pressure	316 L stainless steel: 16 bar/130 °C (232 psig at 266 °F)	
Insertion lengths	100 mm (3.94")	
Wetted parts	316 L stainless steel	
Wetted O-rings	Viton®-FDA, EPDM-FDA, Kalrez®-FDA-USP Class VI	
Housing length	100 mm:	460 mm (18.1") in process 715 mm (28.2") retracted from process
Pneumatic conditions	4 to 8 bar (58 to 116 psig)	
Flushing connections (water, steam)	2 to 6 bar (29 to 87 psig)	
Position monitoring (options)	Pneumatic check (¾ way valve), G¼"	
	Inductive check, non-Ex, M12 × 1	
	Inductive check, Ex, M12 × 1	

### Certificates and Approvals

CE;  
Pressure Equipment Directive guidelines (PED);  
Certificate of conformity according to EN10204-2.1;  
Material certificate according to 3.1;  
ATEX, FM and MaxCert

### InTrac 797 e/InTrac 799 e Sensor Fit Guide

Sensor Length	Insertion Length	
297 mm	100 mm	∅ 12 mm Sensor /electrode
320 mm	• <sup>1</sup>	Turbidity
325 mm	• <sup>2</sup>	O <sub>2</sub> , CO <sub>2</sub>
		pH/ORP

1 InTrac 799 e only

2 InTrac 797 e only

Many housing options are available. Please use the product configurator found on p. 138.

▶ [www.mt.com/InTrac797](http://www.mt.com/InTrac797)

▶ [www.mt.com/InTrac799](http://www.mt.com/InTrac799)



# InTrac 781/784

## Designed for the Toughest Process Conditions



InTrac 781

InTrac 784

### Other Highlights

- Multiple process connections available
- Large choice of materials for wetted parts
- Variable insertion length
- Compliance with international standards
- Long life and easily exchangeable seals

The InTrac 781/784 retractable housings combine rugged design with great versatility to meet the demands of the harshest process conditions in chemical, petrochemical, pulp and paper, or utilities applications.

The InTrac 781 operates mainly with the 12 mm diameter (Pg 13.5) sensors, while the InTrac 784 operates with the InPro 2000 (i)/465 pH/ORP sensor.

The retractable housing material is specially designed for a range of harsh applications. Wetted parts are available in different materials (1.4404/SS 316L; Alloy C-22, PP; PVDF or PEEK), offering installation flexibility in many applications. The intelligent sensor locking system in the housing enhances operational safety. Without the presence of a sensor, the housing cannot be inserted into the process. Also, it makes it possible to remove the sensor from the housing when in the service position.

### Specifications

Operation	Manual or pneumatic or pneumatic with inductive check back
Ambient temperature	SS 316L, Alloy C-22: -10 to 70 °C (14 ... 158 °F) PP, PVDF, PEEK: 0 to 70 °C (32 ... 158 °F)
Max. permissible pressure and temperature	SS 316L, Alloy C-22: 16 bar/120 °C or 10 bar/140 °C (232 psi/248 °F or 145 psi/284 °F) PP: 4 bar/60 °C or 2 bar/70 °C (58 psi/140 °F or 29 psi/158 °F) PVDF: 6 bar/90 °C or 4 bar/100 °C (87 psi/194 °F or 58 psi/212 °F) PEEK: 10 bar/100 °C or 6 bar/120 °C (145 psi/212 °F or 87 psi/248 °F)
Insertion length	80 mm (3.15") or 280 mm (11.02")
Wetted parts	SS 316L, Alloy C-22, PP, PVDF, PEEK or PVDF
Wetted O-rings	Viton®, Kalrez® or EPDM
Process connections	Flanges: DIN or AISI, or NPT 1 1/4"
Pneumatic condition	4 to 6 bar
Flushing condition (water)	1 to 6 bar
<b>Certificates and Approvals</b>	CE; Pressure Equipment Directive guideline (PED); ATEX and FM

Many housing options are available. Please use the product configurator found on p. 139.

### Features Overview

- Highly efficient cleaning chamber
- Intelligent sensor locking system to prevent unintentional removal of the sensor
- Integrated sensor protective cage to protect the sensor in cases of fast process flow
- Specially designed drive train allows sensor retraction from high process pressures and temperatures
- Automated sensor cleaning with EasyClean

## Retractable Housings

Sensor Access Without Process Interruption



Housings

# InTrac 785/787 For Harsh Applications



InTrac 785

InTrac 787

InTrac 785/787 is a rugged, retractable housing for the most demanding industrial applications. Sensor maintenance and replacement becomes a fast and easy task using the InTrac 785/787, and can be done without any interruption to your process. Once retracted, the integral ball valve completely seals off your process, preventing loss of medium or contamination. The design allows for direct mounting to process lines, tanks and reactor vessels.

The InTrac 785 allows a wide range of installation possibilities, thanks to the wide variety of process connections and materials for wetted parts. If the ball valve is already present or a factory standard needs to be used, this housing is also available without ball valve and process connection.

Specifications	InTrac 785	InTrac 787
Wetted parts	316L, C22, titanium Ball valve always made of 1.4408	Stainless 316L
Surface finish	N6 (R <sub>a</sub> 32)	N6/N5 (R <sub>a</sub> 32/R <sub>a</sub> 16)
O-ring	Viton®, Kalrez®	Viton®-FDA
Sensor fitting	Pg 13.5	Pg 13.5
Temperature range	Up to 140 °C/276 °F	Up to 140 °C/276 °F
Pressure rating	16 bar (232 psi)	9 bar (130 psi)

**Certificates and Approvals** CE, Pressure Equipment Directive guidelines (PED)

### Suggested Sensors InTrac 785

pH	DO	CO <sub>2</sub>	Conductivity	Turbidity
All 425 mm	All 420 mm	N/A	InPro 7100/425*	All 409 mm

\* with InTrac 785 without protective cage

### Suggested Sensors InTrac 787 (all 120 mm length)

pH	DO	CO <sub>2</sub>	Conductivity	Turbidity
InPro 3030	InPro 6050	N/A	InPro 7001	InPro 8050
InPro 3100 (i)	InPro 6800 (G)		InPro 7108	InPro 8100
InPro 3250 (i)	InPro 6850 (i) (G)		InPro 7100 (i)	InPro 8200
InPro 4010	InPro 6900 (i) (G)			
InPro 4260 (i)	InPro 6950 (i) (G)			
InPro 4281 i				
InPro 4800 (i)				
InPro 4881 (i)				
DPA				
DPAS				
DXK				

Many housing options are available. Please use the product configurator for InTrac 785 found on p. 138 or ordering information for InTrac 787 found on p. 139.

### Features Overview

- Anti-blowout tip prevents accidental blowout
- Variable insertion length
- Flushing chamber available
- Wide range of installation options
- Flexibility in maintenance intervals due to sensor access during running process
- Smooth and reliable operation even in applications with high fiber concentration

▶ [www.mt.com/InTrac785](http://www.mt.com/InTrac785)

▶ [www.mt.com/InTrac787](http://www.mt.com/InTrac787)

## Product Configurators

### InTrac 777 e/InTrac 779 e Sensor Fit Guide

Sensor Length	Insertion Length			
	70 mm	100 mm	200 mm	295 mm
205 mm (Turbidity)	• <sup>1</sup>	• <sup>1</sup>	–	–
220 mm (O <sub>2</sub> /CO <sub>2</sub> )	•	•	–	–
225 mm (pH/ORP)	•	•	–	–
407 mm (Turbidity)	–	–	• <sup>1</sup>	–
420 mm (O <sub>2</sub> /CO <sub>2</sub> )	–	–	•	•
425 mm (pH/ORP/Conductivity)	–	–	•	•

<sup>1</sup> InTrac 779e only

### Product configurator: InTrac 776 e, InTrac 777 e, and InTrac 779 e – not all configurations are possible

	Flushing Chamber	Sensor Type	Operation Mode	Insertion Length in mm	Material Wetted Parts	Process Connection	O-ring Material	Body Material	Flushing Connections
Pharma	9 (double)	7 (Gel- or Polymer electrolyte Electrodes and Sensors with Pg 13.5 thread) 9 (Turbidity Sensors)	I (Pneumatic operation with inductive position indication, non-Ex) M (Manual operation (not for 295 mm))	0070 0100 0200	4404 C22–	D00 (Ingold DN25 (20mm Hexagon)) T01 (Tri-Clamp flange 1.5", straight) T02 (Tri-Clamp flange 2", straight)	Vi (FKM Viton® FDA) EP (EPDM FDA) Ka (FFKM Kalrez® 6230 FDA/USP Class VI)	A POM conducting (not for 295 mm)	0 (Without)
Food & Bev.	7 (single) 9 (double)	7 (Gel- or Polymer electrolyte Electrodes and Sensors with Pg 13.5 thread)				V01 (Varivent flange DN50, straight)			
Chemical & Others	1 (single)	6 (liquid electrolyte) 7 (Gel- or Polymer electrolyte Electrodes and Sensors with Pg 13.5 thread) 9 (Turbidity Sensors)	P (Pneumatic operation) X (Pneumatic operation with inductive position indication, Ex)	0070 0100 0200 0295	4404 C22– (on request for 295 mm) Ti– (on request for 295 mm) PP (not for 295 mm) PEEK (not for 295 mm)	D03 (flange DN40 PN16) D04 (flange DN50 PN16) A02 (flange ANSI A150 – 1.5") A03 (flange ANSI A150 – 2") A04 (flange ANSI A150 – 3") N01 (NPT 1")			
	<input type="checkbox"/>	<input type="checkbox"/>	<input type="checkbox"/>	<input type="checkbox"/> <input type="checkbox"/> <input type="checkbox"/> <input type="checkbox"/>	<input type="checkbox"/> <input type="checkbox"/> <input type="checkbox"/> <input type="checkbox"/>	<input type="checkbox"/> <input type="checkbox"/> <input type="checkbox"/>	<input type="checkbox"/> <input type="checkbox"/>	<input type="checkbox"/>	<input type="checkbox"/>



### InTrac 777e

Hastelloy and titanium housings have cap nuts made of stainless steel. Varivent and Tri-Clamp flanges are available in stainless steel only.

# Retractable Housings

Sensor Access Without Process Interruption

Housings

## Product configurator: InTrac 797 e, InTrac 799 e – not all configurations are possible

	Flushing Chamber	Sensor Type	Operation Mode	Insertion Length in mm	Material Wetted Parts	Process Connection	O-ring Material	Body Material	Flushing Connections
Pharma	9 (double)	7 (Gel- or Polymer electrolyte Electrodes and Sensors with Pg 13.5 thread) 9 (Turbidity Sensors)	I (Pneumatic operation with inductive position indication, non-Ex) M (Manual operation (not for 295 mm))	0070 0100 0200	4404 C22-	D00 (Ingold DN25 (20mm Hexagon)) T01 (Tri-Clamp flange 1.5", straight) T02 (Tri-Clamp flange 2", straight)			
	7 (single) 9 (double)	7 (Gel- or Polymer electrolyte Electrodes and Sensors with Pg 13.5 thread)				V01 (Varivent flange DN50, straight)			
	Food & Bev.			P (Pneumatic operation) X (Pneumatic operation with inductive position indication, Ex)		4404 C22- (on request for 295 mm) TI- (on request for 295 mm) PP (not for 295 mm) PEEK (not for 295 mm)	D03 (flange DN40 PN16) D04 (flange DN50 PN16) A02 (flange ANSI A150 - 1.5") A03 (flange ANSI A150 - 2") A04 (flange ANSI A150 - 3") N01 (NPT 1")	VI (FKM Viton® FDA) EP (EPDM FDA) Ka (FFKM Kalrez® 6230 FDA/USP Class VI)	A POM conducting (not for 295 mm)) S (DIN 1.4404/316 L)
Chemical & Others	1 (single)	6 (liquid electrolyte) 7 (Gel- or Polymer electrolyte Electrodes and Sensors with Pg 13.5 thread) 9 (Turbidity Sensors)		0070 0100 0200 0295					
	<input type="checkbox"/>	<input type="checkbox"/>	<input type="checkbox"/>	<input type="checkbox"/> <input type="checkbox"/> <input type="checkbox"/> <input type="checkbox"/>	<input type="checkbox"/> <input type="checkbox"/> <input type="checkbox"/> <input type="checkbox"/>	<input type="checkbox"/> <input type="checkbox"/> <input type="checkbox"/>	<input type="checkbox"/> <input type="checkbox"/>	<input type="checkbox"/>	<input type="checkbox"/>

## Product configurator: InTrac 785 – not all configurations are possible

<b>Electrode/Sensor type</b>	<b>5</b> For pH, turbidity and oxygen sensors (length 425 mm/409 mm/420 mm)																																																	
<b>Sensor holder</b>	<b>A</b> Standard with protective cage (sensor design Ø 12 mm shaft and Pg 13.5 thread) <b>B</b> Without protective cage																																																	
<b>Flushing chamber</b>	<b>F</b> Including flushing chamber <b>N</b> No flushing chamber																																																	
<b>Insertion length</b>	<b>2 2 0</b> 220 mm/8.66" immersion length (insertion length can be adjusted from 0–220 mm/0"–8.66")***																																																	
<b>Material (wetted parts)</b>	<table border="1" style="width: 100%; border-collapse: collapse;"> <tr> <td style="width: 20px;"><b>4</b></td> <td style="width: 20px;"><b>4</b></td> <td style="width: 20px;"><b>3</b></td> <td style="width: 20px;"><b>5</b></td> <td>DIN 1.4435/316L</td> </tr> <tr> <td><b>C</b></td> <td><b>2</b></td> <td><b>2</b></td> <td>–</td> <td>DIN 2.4602/Alloy C22*</td> </tr> <tr> <td><b>T</b></td> <td><b>i</b></td> <td>–</td> <td>–</td> <td>Titanium*</td> </tr> </table>																														<b>4</b>	<b>4</b>	<b>3</b>	<b>5</b>	DIN 1.4435/316L	<b>C</b>	<b>2</b>	<b>2</b>	–	DIN 2.4602/Alloy C22*	<b>T</b>	<b>i</b>	–	–	Titanium*					
<b>4</b>	<b>4</b>	<b>3</b>	<b>5</b>	DIN 1.4435/316L																																														
<b>C</b>	<b>2</b>	<b>2</b>	–	DIN 2.4602/Alloy C22*																																														
<b>T</b>	<b>i</b>	–	–	Titanium*																																														
<b>Process connections</b>	<table border="1" style="width: 100%; border-collapse: collapse;"> <tr> <td style="width: 20px;"><b>N</b></td> <td style="width: 20px;"><b>1</b></td> <td style="width: 20px;"><b>0</b></td> <td>NPT 1"</td> </tr> <tr> <td><b>N</b></td> <td><b>1</b></td> <td><b>4</b></td> <td>NPT 1 ¼" (with adapter 1" to 1 ¼")</td> </tr> <tr> <td><b>A</b></td> <td><b>0</b></td> <td><b>2</b></td> <td>ANSI A150–1.5" (with adapter 1" NPT to ANSI A150–1.5")</td> </tr> <tr> <td><b>D</b></td> <td><b>0</b></td> <td><b>4</b></td> <td>DIN DN50–PN16 (with adapter 1" NPT to DIN DN50–PN16)</td> </tr> <tr> <td><b>w</b></td> <td><b>/</b></td> <td><b>o</b></td> <td>Without ball valve and process connection for direct installation**</td> </tr> </table>																														<b>N</b>	<b>1</b>	<b>0</b>	NPT 1"	<b>N</b>	<b>1</b>	<b>4</b>	NPT 1 ¼" (with adapter 1" to 1 ¼")	<b>A</b>	<b>0</b>	<b>2</b>	ANSI A150–1.5" (with adapter 1" NPT to ANSI A150–1.5")	<b>D</b>	<b>0</b>	<b>4</b>	DIN DN50–PN16 (with adapter 1" NPT to DIN DN50–PN16)	<b>w</b>	<b>/</b>	<b>o</b>	Without ball valve and process connection for direct installation**
<b>N</b>	<b>1</b>	<b>0</b>	NPT 1"																																															
<b>N</b>	<b>1</b>	<b>4</b>	NPT 1 ¼" (with adapter 1" to 1 ¼")																																															
<b>A</b>	<b>0</b>	<b>2</b>	ANSI A150–1.5" (with adapter 1" NPT to ANSI A150–1.5")																																															
<b>D</b>	<b>0</b>	<b>4</b>	DIN DN50–PN16 (with adapter 1" NPT to DIN DN50–PN16)																																															
<b>w</b>	<b>/</b>	<b>o</b>	Without ball valve and process connection for direct installation**																																															
<b>O-Ring material</b>	<table border="1" style="width: 100%; border-collapse: collapse;"> <tr> <td style="width: 20px;"><b>V</b></td> <td style="width: 20px;"><b>i</b></td> <td>FKM Viton®</td> </tr> <tr> <td><b>K</b></td> <td><b>a</b></td> <td>FFKM Kalrez®</td> </tr> </table>																														<b>V</b>	<b>i</b>	FKM Viton®	<b>K</b>	<b>a</b>	FFKM Kalrez®														
<b>V</b>	<b>i</b>	FKM Viton®																																																
<b>K</b>	<b>a</b>	FFKM Kalrez®																																																
<b>Special</b>	<table border="1" style="width: 100%; border-collapse: collapse;"> <tr> <td style="width: 20px;">–</td> <td>Standard</td> </tr> <tr> <td><b>S</b></td> <td>Special</td> </tr> </table>																														–	Standard	<b>S</b>	Special																
–	Standard																																																	
<b>S</b>	Special																																																	
<b>InTrac 7 8</b>	<input type="checkbox"/>	<input type="checkbox"/>	<input type="checkbox"/>	<input type="checkbox"/>	<input type="checkbox"/>	<input type="checkbox"/>	<input type="checkbox"/>	<input type="checkbox"/>	<input type="checkbox"/>	<input type="checkbox"/>	<input type="checkbox"/>	<input type="checkbox"/>	<input type="checkbox"/>	<input type="checkbox"/>	<input type="checkbox"/>	<input type="checkbox"/>	<input type="checkbox"/>	<input type="checkbox"/>	<input type="checkbox"/>	<input type="checkbox"/>	<input type="checkbox"/>	<input type="checkbox"/>	<input type="checkbox"/>	<input type="checkbox"/>	<input type="checkbox"/>	<input type="checkbox"/>	<input type="checkbox"/>	<input type="checkbox"/>	<input type="checkbox"/>	<input type="checkbox"/>	<input type="checkbox"/>	<input type="checkbox"/>	<input type="checkbox"/>	<input type="checkbox"/>	<input type="checkbox"/>	<input type="checkbox"/>	<input type="checkbox"/>	<input type="checkbox"/>												

\* Ball valve made of SS 1.4408, \*\* For exact ball valve requirements please refer to the instruction manual, \*\*\* Insertion length will be reduced by 40 mm/1.56" by using a flushing chamber.

**Ordering Information for InTrac 787**

	<b>Process Connect</b>	<b>Bore Size</b>	<b>Insertion Length</b>	<b>Wetted Parts</b>	<b>Order Number</b>
InTrac 787/100mm (4")	NPT/1.5"	1.5"	0–100mm/0"–4"	SS	52 402 401
InTrac 787/300mm (12")	NPT/1.5"	1.5"	0–300mm/0"–12"	SS	52 402 402
O-ring kit	N/A	N/A	N/A	Viton®-FDA	52 402 403
Adapter set 787/4801 SG 3.1 B	N/A	N/A	N/A	SS	52 402 701

**Product configurator: InTrac 781, InTrac 784 – not all configurations are possible**

<b>Sensor type</b>																																		
7	8	1	Solid [781] solid electrolyte, DO, Cond																															
7	8	4	Liquid [784] liquid electrolyte (InPro2000, 465)																															
<b>Operating mode and indicators</b>																																		
M Manual [M]																																		
R Pneumatic check back [R]																																		
I Pneumatic, Inductive check back [I]																																		
<b>Material, medium-wetted parts</b>																																		
4 4 0 4 1.4404 [4404]																																		
C 2 2 – 2.4602/Alloy C22 [C22_]																																		
P P – – PP [PP_]																																		
P V D F PVDF [PVDF]																																		
P E E K PEEK [PEEK]																																		
P V D H PVDF / Alloy C22 [PVDH]																																		
<b>Sealing material (wetted sealings)</b>																																		
V I Viton [Vi]																																		
K A Kalrez [Ka]																																		
E P EPDM [EP]																																		
<b>Sensor- / Insertion length</b>																																		
2 2 5 225 mm / [225]																																		
4 2 5 425 mm / [425]																																		
2 5 0 250 mm / [250]																																		
4 5 0 450 mm / [450]																																		
<b>Process connection</b>																																		
D 0 0 Ingold DN25 [D00]																																		
D 0 2 DN32 PN16 [D02]																																		
D 0 3 DN40 PN16 [D03]																																		
D 0 4 DN50 PN16 [D04]																																		
D 0 6 DN80 PN16 [D06]																																		
A 0 1 A150-1 1/4 [A01]																																		
A 0 2 A150-1 1/2 [A02]																																		
A 0 3 A150-2 [A03]																																		
A 0 4 A150-3 [A04]																																		
N 0 2 NPT 1 1/4 [N02]																																		
<b>Flushing connections</b>																																		
O 0 – Without (blind plugs included)																																		
G 1 8 G 1/8" thread female [G18]																																		
G 1 4 G 1/4" thread female [G14]																																		
N 1 4 1/4" NPT female [N14]																																		
<b>InTrac</b>	7	8			/					/					/					/					/									
	7	8	9	10	11	12	13	14	15	16	17	18	19	20	21	22	23	24	25	26	27	28	29	30										

# EasyClean

## Process Reliability Through Targeted Automation

EasyClean systems are feature-rich and compact. Chemical processing, food processing, bio-pharmaceutical processes, and other industrial applications all benefit from EasyClean's ability to automate routine maintenance. Just choose the most appropriate Ingold sensor, housing, and transmitter for your process, then add an EasyClean system to give you the exact amount of automation you need.

### Flexibility of sensor maintenance

In conjunction with the METTLER TOLEDO Ingold transmitter line, sensor maintenance is fully automated. However, manual operation is also possible whenever required. An integrated controller identifies each ongoing working step, as well as any functional problems within the system.

### Safety

EasyClean carries out continuous system diagnostics. In the event of any system anomaly the electrode remains inserted in the sample medium in order to ensure continued parameter measurement and prevent process interruption.

### System overview EasyClean 500 (X)

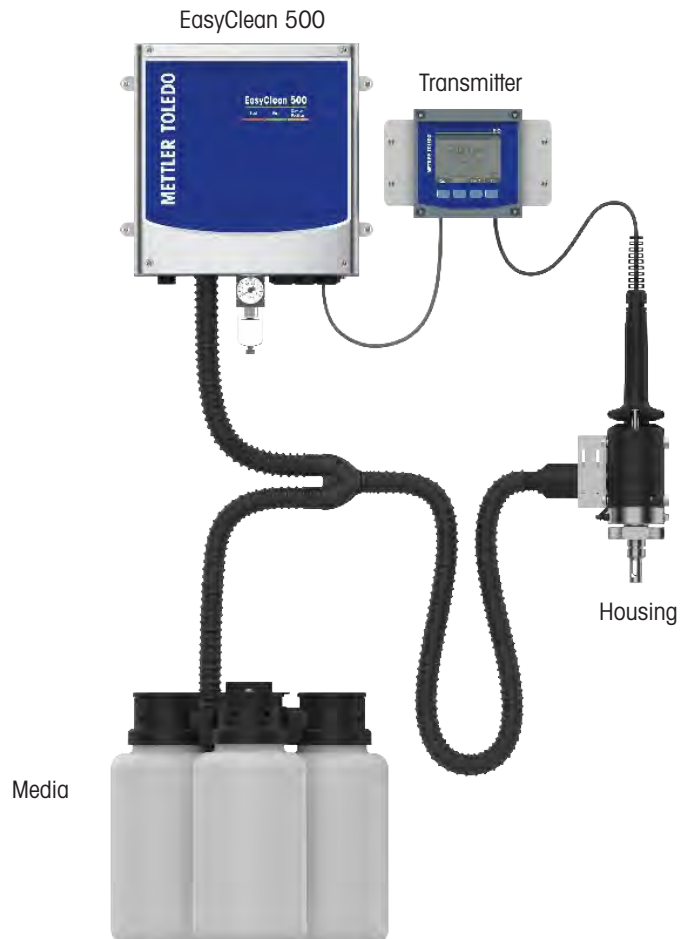

# EasyClean Configuration

## Custom

	EC 500(X)	EC 200e	EC 150	EC 100
<b>Functionality</b>				
Flushing	●	●	●	●
Cleaning	●	●	●	●
Calibration	●	●	●	●
System integration	●	●	●	●
HART	●	●	●	●
Ex. areas	●	●	●	●
<b>Housing</b>				
InDip 550				●
InTrac 7XXe	1	2	●	●
<b>Transmitter</b>				
M300		●	●	●
M400		●	●	●
M400 2-wire	●	●	●	●
M800		●	●	●
<b>Sensor</b>				
pH	●	●	●	●
O <sub>2</sub>	●	●	●	●
CO <sub>2</sub>	●	●	●	●
Turbidity	●	●	●	●
Conductivity	●	●	●	●

1 support InTrac 777e only  
2 with inductive position indicators

This section will assist you with configuration based upon your specific requirements. The following example creates a fully automated EasyClean system for a “typical” industrial processing application. For harsh chemical environments, choose a compatible industrial sensor housing combination and an EasyClean system to give you the level of automation desired. The ordering information provided on p. 145 will help you choose the appropriate system components. Please make sure you choose one item from each of the sections marked with a ▲.

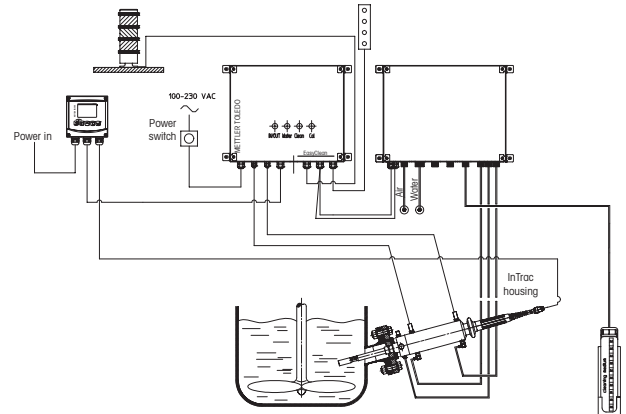

Schematic of a typical EasyClean custom installation

### Configuring your EasyClean system (example)

	Product Description	Order Number	P.
* EasyClean system	EasyClean 200 e	52 403 776	143
Option:	Empty canister (5000 ml)	52 118 063	–
Option:	Connection cable: control unit ► transmitter (5 m / 16.4 ft)	52 300 265	145
Option:	Wall mounting kit, complete	52 402 306	145
* Transmitter	M400 Type 1	30 374 111	97
* Sensor cable	VP cable 3 m (9.8 ft)	52 300 108	148
* Sensor	InPro 3250 SG/225 mm	52 002 560	25
* Housing	InTrac 777 e-I	52 403 216	133

\* Required system component for operation

**Note: For full functionality, housings must have position sensors when used with an EasyClean 200 e or 500 system.**



# EasyClean 500

## Flexible, for the Highest Demands



EasyClean 500 is used for fully automatic cleaning and calibration of pH, ORP, and oxygen measuring points. In combination with the transmitter M400 2-wire and the InTrac 777 e retractable housing it provides a flexible system solution which can be implemented into either continuous or batch measurements.

EasyClean 500 is versatile in its application. It offers multiple control possibilities and can be programmed extensively. Furthermore, a version for applications in explosion hazardous areas is available. The connection to a supervisory process control system can easily be realized in a conventional way, via point-to-point or via HART.

### Specifications

Protection	IP 65
Power	EasyClean 500: 15 V ~ 30V/100 mA EasyClean 500X: 15 ~ 30 V (Safety barrier required, [Ex ib Gb]), U <sub>i</sub> =30V, I <sub>i,max</sub> =100 mA, P <sub>i,max</sub> =800 mW)
Compressed air supply	4–10 bar (58–145 psi)
Flushing supply	2–6 bar (29–87 psi)
Ambient conditions	+5°C...55°C (+5...131 °F)
Communication protocol	HART (via transmitter)

- Completely unattended maintenance operation
- Allows maintenance teams to focus on more important and skill-intensive tasks
- Expanded operations without adding staff
- Ensured system performance and process control

### Features Overview

- Minimizes maintenance costs by fully automatic cleaning and calibration of the sensor
- Optimal adaptation to the process conditions thanks to diverse program runs with freely programmable sequences
- High flexibility thanks to free choice of individually programmable intervals or weekly programs
- EasyClean 500 ensures a safe application in explosion hazardous areas

▶ [www.mt.com/EC500](http://www.mt.com/EC500)



# EasyClean 200 e

## Fully Automated Rinsing and Cleaning



The EasyClean 200e systems fully automate rinsing and cleaning procedures for the parameters pH, ORP, dissolved oxygen, CO<sub>2</sub>, conductivity, and turbidity. EasyClean 200e does not feature a calibration option, but it greatly reduces maintenance requirements and improves performance.

### Specifications

Protection	IP 65
Power	100–230 VAC 50/60 Hz 0.18–0.3 A
Compressed air supply	4–8 bar (58–116 psi)
Flushing supply	2–8 bar (29–116 psi)
Pump	Delivery distance: 10 m (32.8 ft) Suction height: 3 m (9.8 ft)

### Features Overview

- Modular configuration provides many installation options
- Many accessories available for customized installation and operational requirements

### Other Highlights

- Configured for immediate operation
- Easily customized for special requirements
- Manual operation override if desired
- Fully automated operation for pH, ORP, dissolved oxygen, CO<sub>2</sub>, conductivity, and turbidity
- Optimal cleaning effect due to the adjustable residence time

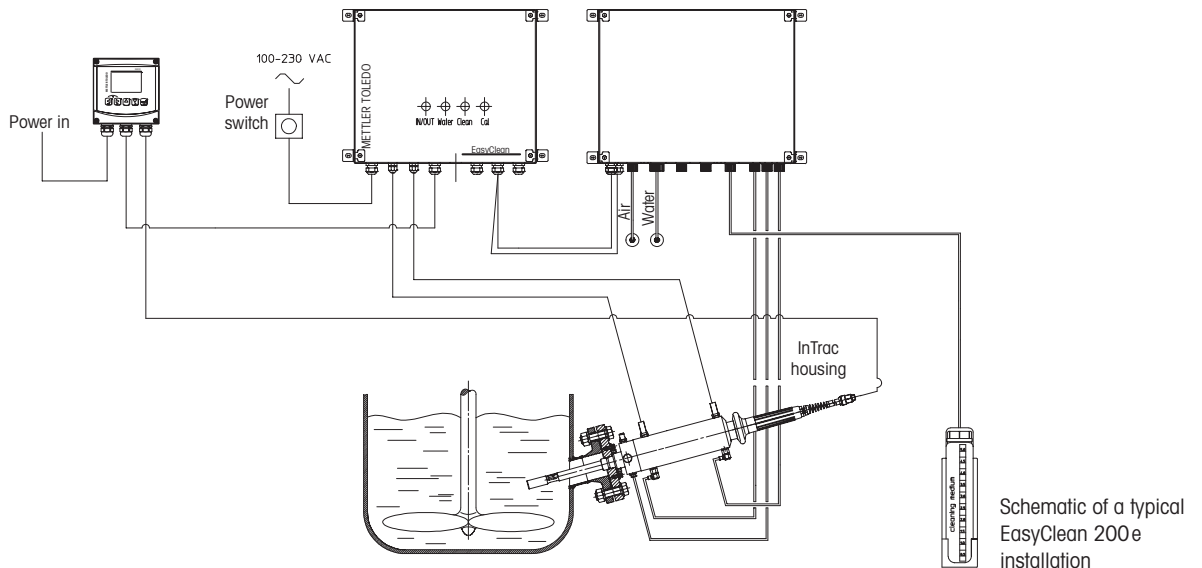

## EasyClean 150/100 Automated Rinsing

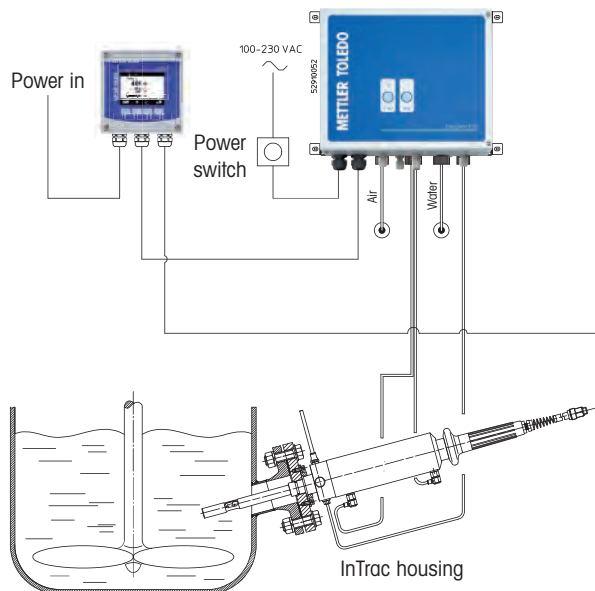

Schematic of a typical EasyClean 150 installation

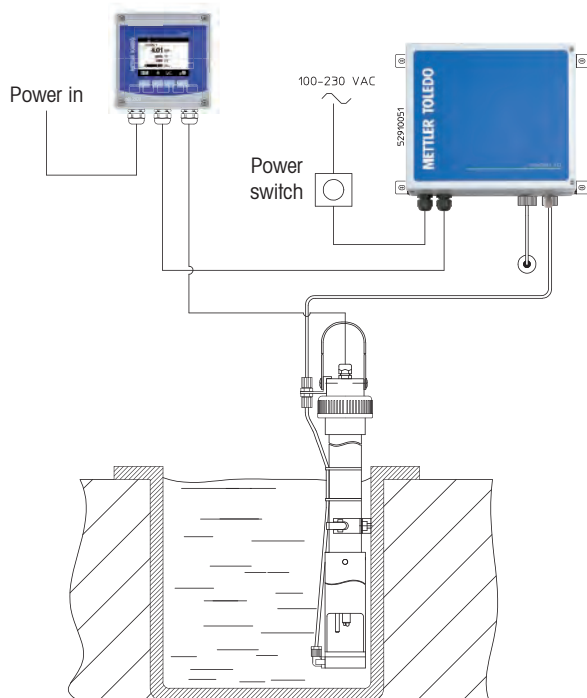

Schematic of a typical EasyClean 100 installation

The EasyClean 100 and 150 series are designed to provide completely automatic sensor rinsing. The EasyClean 100 system is designed to be used with a stationary InDip housing with a spray-head for open tank and basin applications. The EasyClean 100 can use either water rinsing or compressed air to create turbulence to prevent stubborn build-up. The EasyClean 150 works in conjunction with a retractable housing to withdraw the electrode from the process prior to automatic water rinsing.

### Specifications

Protection	IP 65
Power	100–230 VAC 50/60 Hz 0.18–0.3 A
Compressed air supply	4–8 bar (58–116 psig) (EasyClean 150)
Flushing supply	2–6 bar (29–87 psig)

### Features Overview

- Modular design allows complete flexibility
- Universal components for easy serviceability
- Entry-level – moderate fouling environments

### Other Highlights

- Simple design and fast setup
- Standard program for immediate operation
- Manual operation override if desired



EasyClean 100 cleaning action. The bubble formation centered beneath the sensor guarantees gentle cleaning.

▶ [www.mt.com/EC150](http://www.mt.com/EC150)  
▶ [www.mt.com/EC100](http://www.mt.com/EC100)

### ▲ EasyClean Systems

Product	100	150	200 e	500 (X)	Order Number
EasyClean 100	•	–	–	–	52 402 304
EasyClean 150	–	•	–	–	52 402 319
EasyClean 200 e	–	–	•	–	52 403 776
EasyClean 500	–	–	–	•	30 900 558
EasyClean 500 X	–	–	–	•	30 900 560

### ▲ Transmitters

M300 Process transmitter	•	•	•	–	See transmitter section
M400 transmitter	•	•	•	–	See transmitter section
M400 2-wire transmitter	•	•	•	•	See transmitter section
M800 transmitter	•	•	•	–	See transmitter section

### ▲ Sensor

pH	•	•	•	•	See all sensors
Dissolved oxygen, turbidity, conductivity, CO <sub>2</sub>	•	•	•	• <sup>①</sup>	See all sensors

### ▲ Sensor Cables

Cable AK9/3 m (9.8 ft) (digital pH, DO, CO <sub>2</sub> and Conductivity)	•	•	•	•	59 902 193
VP cable–ST/1.5 m (4.9 ft) (conductivity)	•	•	•	–	58 080 201
Other length cables	•	•	•	•	See cable section

### ▲ Sensor Housings

InTrac 7XXe	–	•	• <sup>②</sup>	• <sup>③</sup>	See housings section
InDip 550	•	–	–	–	See housings section
Spray head for InDip 550 (PVC)	•	–	–	–	52 402 291
Spray head for InDip 550 (PVDF)	•	–	–	–	52 402 290

### Calibration Supplies

Buffer pH 4.01, 5000 ml	–	–	–	•	51 319 012
Buffer pH 7.00, 5000 ml	–	–	–	•	51 319 016
Buffer pH 9.21, 5000 ml	–	–	–	•	51 319 017

### Options

Transmitter cable 5 m (16.4 ft)	•	•	•	–	52 300 265
Transmitter cable 10 m (32.8 ft)	•	•	•	–	52 300 266
Compressed air hose LDPE 20 m (65.6 ft)	•	•	•	–	52 402 314
Pneumatic hose PU 6/4 mm	–	•	•	–	52 401 322
Fittings pneumatic/hydraulic	–	•	•	–	52 402 337
Wall-mount kit	•	•	•	–	52 402 306
Post-mount kit	•	•	•	–	52 402 308
Weatherproof hood	•	•	•	–	52 402 316









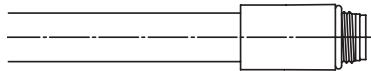
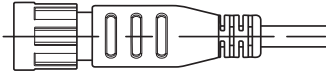

- ▲ One item required for system operation
- ① Only support oxygen sensors
- ② Inductive position indicators required
- ③ Support InTrac 777 e only

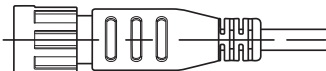
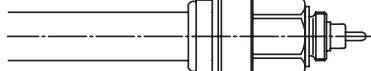
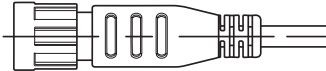
## Cables and Connections Sensor Heads/Cable Sockets

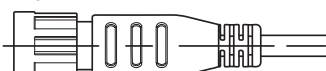
Interconnection cables from the sensor to the transmitter play an important role in providing reliable process measurements. In addition to carrying the particular parameter signal, in some cases temperature, solution ground and supply voltages are also required. Internal cable shielding and appropriate cable connectors assure noise-free, reliable signal transfer. A wide variety of cables is available to meet

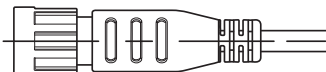
the specific installation requirement. Below is a listing of common cables. The sensor head connection is shown below in the left column with the corresponding cable connection shown directly to the right.

Available sensor / cable adapters are listed on p. 147. Contact METTLER TOLEDO for additional configurations and custom application requirements.

Sensor Heads	Adapters (see next page)	Cable Sockets	Parameter
S7 		AS9 	pH/redox
S8 (with Pg 13.5) 		AS9 	pH/redox
K8S (with Pg 13.5 autoclavable) 		AK9 	pH/redox
ISM: K8S 		AK9 	pH/redox/DO
K9 (autoclavable) 		AK9 	pH/redox
VP6/VP8 sensor head 		VP6/VP8 cable socket 	pH/redox/DO/ CO <sub>2</sub> /Cond
O <sub>2</sub> flange plug type T-82 		O <sub>2</sub> cable socket T-82 	DO



### Did You Know





The VP cable blind plug keeps the cable socket dry when the sensor is removed for service.

# Cable Terminations

## Custom Cable Plugs to Transmitter or Appliances

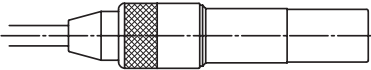
Note: Standard cables are delivered with one end open for transmitter connection. On request, cable plugs can be ordered for different appliances.

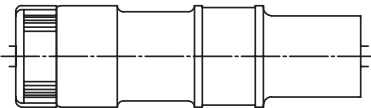
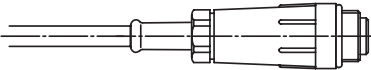
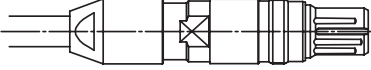
The most commonly used plugs are shown below. Ask for other types from your METTLER TOLEDO representative.

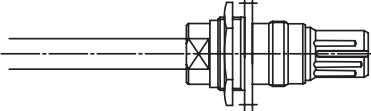
Applications		Parameter
Appliance coupler DIN 15.50D Coaxial plug (DIN 19262) for 5 mm cable		pH/redox
Appliance coupler BNC-50 Coaxial plug for 5 mm cable		pH/redox
Coax connector for gas- and watertight connection of 2 coaxial 5 mm cables		pH/redox
Cable coupler SK9 for lengthening of AS9 5 mm cable		pH/redox
VP plug		pH/redox/DO/CO <sub>2</sub>
VP blind plug		pH/redox/DO/CO <sub>2</sub>
VP apparatus plug Connection as flange or bulkhead		pH/redox/DO/CO <sub>2</sub>

### Cable/Sensor Adapters and Cable Plugs

Description	Order Number
Adapter, to connect from K8S or K9 sensor head to AS9 cable	59 900 227
Adapter, to connect from S7 or S8 sensor head to AK9 cable	59 900 195
Adapter, to connect from T-82 sensor head to VP cable	52 200 940
Adapter, to connect from VP sensor head to T-82 cable	52 200 939
VP cable blind plug	52 300 252

# Cables and Connections/Cable Terminations

Solid Connections for Safe Operation

Cables

### Cable Availability Cross Reference Table

		AKO Cables with K9 or K&S Connector										Variopin (VP) Cables										-30 to 80°C / -22 to 176°F											
		Termination					Length					Termination					Length																
		Tinned Ends	Tinned Ends	Tinned Ends	Tinned Ends	Tinned Ends	0.6 m (2 ft)	1 m (3.3 ft)	3 m (9.8 ft)	5 m (16.4 ft)	10 m (32.8 ft)	20 m (65.6 ft)	30 m (98.4 ft)	50 m (164 ft)	80 m (262.5 ft)	1 m (3.3 ft)	2 m (6.6 ft)	3 m (9.8 ft)	5 m (16.4 ft)	10 m (32.8 ft)	1 m (3.3 ft)	3 m (9.8 ft)	5 m (16.4 ft)	10 m (32.8 ft)	1 m (3.3 ft)	3 m (9.8 ft)	5 m (16.4 ft)	10 m (32.8 ft)	1 m (3.3 ft)	3 m (9.8 ft)	5 m (16.4 ft)		
		BNC	BNC	BNC	BNC	BNC	BNC	BNC	DIN	DIN	DIN/Braun	BNC	BNC	BNC	BNC	DIN	DIN	DIN	DIN/Braun	Tinned Ends	Tinned Ends	Tinned Ends	BNC	BNC	BNC	BNC	DIN	DIN, banana	DIN, banana	DIN, banana			
ISM	pH	pH/ORP ISM (1-wire)	•	•	•	•	•	•	•	•	•	•	•	•																			
	DO/O <sub>2</sub>	DO ISM (1-wire)	•	•	•	•	•	•	•	•	•	•	•	•																			
		InPro 6850 i	•	•	•	•	•	•	•	•	•	•	•	•																			
		InPro 6900 i	•	•	•	•	•	•	•	•	•	•	•	•																			
		InPro 6950 i	•	•	•	•	•	•	•	•	•	•	•	•																			
		O <sub>2</sub> Gas ISM (1-wire)	•	•	•	•	•	•	•	•	•	•	•	•																			
Cond CO <sub>2</sub>	InPro 5000 i	•	•	•	•	•	•	•	•	•	•	•	•																				
	InPro 7000 i	•	•	•	•	•	•	•	•	•	•	•	•																				
Analog Sensors	pH	InPro 2000																		•	•	•	•	•	•	•	•	•	•	•	•	•	
		InPro 3100/UD																			•	•	•	•	•	•	•	•	•	•	•	•	•
		InPro 3250/SG																			•	•	•	•	•	•	•	•	•	•	•	•	•
		InPro 3251																			•	•	•	•	•	•	•	•	•	•	•	•	•
		InPro 3252																			•	•	•	•	•	•	•	•	•	•	•	•	•
		InPro 3253/SG																			•	•	•	•	•	•	•	•	•	•	•	•	•
		InPro 3300																			•	•	•	•	•	•	•	•	•	•	•	•	•
		InPro 4010																			•	•	•	•	•	•	•	•	•	•	•	•	•
		InPro 4260/SG																			•	•	•	•	•	•	•	•	•	•	•	•	•
		InPro 4262																			•	•	•	•	•	•	•	•	•	•	•	•	•
		InPro 4501																			•	•	•	•	•	•	•	•	•	•	•	•	•
		InPro 4550																			•	•	•	•	•	•	•	•	•	•	•	•	•
		InPro 4800/SG																			•	•	•	•	•	•	•	•	•	•	•	•	•
		InPro 4801 SG																			•	•	•	•	•	•	•	•	•	•	•	•	•
		InPro 4802																			•	•	•	•	•	•	•	•	•	•	•	•	•
		Puncture																			•	•	•	•	•	•	•	•	•	•	•	•	•
	DO/O <sub>2</sub>	InPro 6050																			•	•	•	•	•	•	•	•	•	•	•	•	
		InPro 6800																			•	•	•	•	•	•	•	•	•	•	•	•	•
		InPro 6800 GAS																			•	•	•	•	•	•	•	•	•	•	•	•	
		InPro 6810																			•	•	•	•	•	•	•	•	•	•	•	•	•
		InPro 6820																			•	•	•	•	•	•	•	•	•	•	•	•	•
		InPro 6830																			•	•	•	•	•	•	•	•	•	•	•	•	•
		InPro 6900																			•	•	•	•	•	•	•	•	•	•	•	•	•
		InPro 6910																			•	•	•	•	•	•	•	•	•	•	•	•	•
		InPro 6950																			•	•	•	•	•	•	•	•	•	•	•	•	•
		InPro 6950 GAS																			•	•	•	•	•	•	•	•	•	•	•	•	•
Conductivity CO <sub>2</sub>	InPro 5000																			•	•	•	•	•	•	•	•	•	•	•	•		
	InPro 7000																			•	•	•	•	•	•	•	•	•	•	•	•	•	
	InPro 7001																			•	•	•	•	•	•	•	•	•	•	•	•	•	
	InPro 7002																			•	•	•	•	•	•	•	•	•	•	•	•	•	
	InPro 7005																			•	•	•	•	•	•	•	•	•	•	•	•	•	
	InPro 7108																			•	•	•	•	•	•	•	•	•	•	•	•	•	
Conv. pH	DXK																																
	DPA																																
	DPAS	•	•	•	•	•	•	•	•	•	•	•	•	•	•	•	•	•	•	•													

Order Number  
 55 902 189  
 59 902 167  
 59 902 193  
 59 902 213  
 52 300 230  
 52 300 204  
 52 300 303  
 52 300 394  
 59 902 395  
 59 902 168  
 59 909 838  
 59 902 94  
 59 902 214  
 59 902 319  
 59 902 165  
 59 902 191  
 59 902 211  
 59 902 208  
 52 300 107  
 52 300 108  
 52 300 09  
 52 300 110  
 52 300 210  
 52 300 211  
 52 300 212  
 52 300 213  
 52 300 08  
 52 300 187  
 52 300 328

For other available cables, please check with your METTLER TOLEDO representative.

-40 to 135 °C/  
-40 to 275 °F

<b>VarioPin (VP) Cables</b>				<b>VarioPin (VP) for InPro 3300 (ISFET)</b>				<b>Cables with Type 82 Connector</b>				<b>Conductivity VP Sensor Cables</b>				<b>AS9 Cables with S7 or S8 Connector</b>				
Termination	Length	Termination	Length	Termination	Length	Termination	Length	Termination	Length	Termination	Length	Termination	Length	Termination	Length	Termination	Length			
Tinned Ends	1 m (3.3 ft)	Tinned Ends	3 m (9.8 ft)	Tinned Ends	3 m (9.8 ft)	Tinned Ends	1 m (3.3 ft)	Tinned Ends	1.5 m (4.9 ft)	Tinned Ends	1 m (3.3 ft)	Tinned Ends	1 m (3.3 ft)	Tinned Ends	1 m (3.3 ft)	BNC	DIN	pH/ORP ISM (1-wire)		
Tinned Ends	3 m (9.8 ft)	Tinned Ends	5 m (16.4 ft)	Tinned Ends	5 m (16.4 ft)	Tinned Ends	3 m (9.8 ft)	Tinned Ends	3 m (9.8 ft)	Tinned Ends	3 m (9.8 ft)	Tinned Ends	3 m (9.8 ft)	Tinned Ends	3 m (9.8 ft)	BNC	DIN	DO ISM (1-wire)		
Tinned Ends	5 m (16.4 ft)	Tinned Ends	10 m (32.8 ft)	Tinned Ends	10 m (32.8 ft)	Tinned Ends	5 m (16.4 ft)	Tinned Ends	4.5 m (14.8 ft)	Tinned Ends	5 m (16.4 ft)	Tinned Ends	5 m (16.4 ft)	Tinned Ends	5 m (16.4 ft)	BNC	DIN	InPro 6850 i		
Tinned Ends	10 m (32.8 ft)			Tinned Ends	3 m (9.8 ft)	Tinned Ends	5 m (16.4 ft)	Tinned Ends	7.5 m (24.6 ft)	Tinned Ends	10 m (32.8 ft)	Tinned Ends	15 m (49.2 ft)	Tinned Ends	25 m (82.0 ft)	DIN	DIN	InPro 6900 i		
				Tinned Ends	5 m (16.4 ft)	Tinned Ends	10 m (32.8 ft)	Tinned Ends	15 m (49.2 ft)	Tinned Ends	20 m (65.6 ft)	Tinned Ends	30 m (98.4 ft)					InPro 6950 i		
																		O <sub>2</sub> Gas ISM (1-wire)		
																		InPro 5000 i		
																		InPro 7000 i		
																		InPro 2000		
																		InPro 3100		
																		InPro 3250		
																		InPro 3251		
																		InPro 3252		
																		InPro 3253 SG		
																		InPro 3300		
																		InPro 4010		
																		InPro 4260		
																		InPro 4262		
																		InPro 4501		
																		InPro 4550		
																		InPro 4800		
																		InPro 4801 SG		
																		InPro 4802		
																		Puncture		
																		InPro 6050		
																		InPro 6800		
																		InPro 6800 GAS		
																		InPro 6810		
																		InPro 6820		
																		InPro 6830		
																		InPro 6900		
																		InPro 6910		
																		InPro 6950		
																		InPro 6950 GAS		
																		InPro 5000		
																		InPro 7000		
																		InPro 7001		
																		InPro 7002		
																		InPro 7005		
																		InPro 7108		
																		DXK		
																		DXK		
																		DPAS		
																		DPAS		





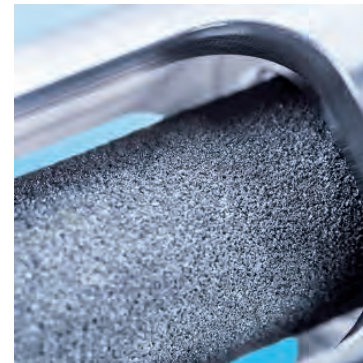
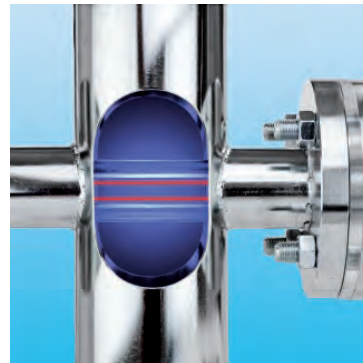
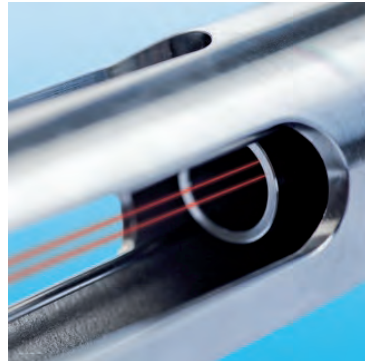

# Gas Analytics Measurement Solutions for Industrial Applications

## Gas Analyzers Measure Where It Really Matters

**Monitoring and controlling the level of harmful or explosive gases in your process is key to ensuring the safety of the environment, people, assets and increasing process efficiency. METTLER TOLEDO's unique range of gas analysis solutions gives you the power to decide where to measure, everywhere it matters.**

Based on long-standing field experience in analytical solutions for liquid measurement, METTLER TOLEDO has developed systems for gas analysis that offer:

- **In situ and in-line capability:** our systems are built to measure, right there where you need to measure
- **Low cost of ownership:** outstanding measurement performance without the drawback of heavy maintenance
- **Ruggedness and long-term stability** for continuous use in the harshest environments.

### The best technology for the job

METTLER TOLEDO's choice of technologies for gas measurement all feature the ability to measure in situ, without the need for gas sampling or conditioning.

- GPro 500 **Tunable Diode Laser (TDL)** analyzers provide the highest level of reliability and fastest response time in process control and safety applications.
- Membrane covered InPro **amperometric oxygen sensors** are largely

insensitive to moisture and dust: they are ideally suited for inerting and blanketing applications.

### TDL: Laser-sharp view into your process

With TDL absorption spectroscopy, a diode laser with a highly specific and extremely narrow emission wavelength is used to resolve single absorption lines of the gas species to be measured. The absorption lines are carefully selected to avoid cross-interference from other background gases. Using direct absorption spectroscopy, a spectrum is taken and compared with spectral reference data stored in the on-board database for any given temperature and pressure. The concentration of the gas is then calculated, and any inconsistency between reference data and measurement will trigger an alarm.

### Process adaptations that fit anywhere

Many users want to reap the benefits of interference-free, drift-free TDL tech-

nology for better process control and lower maintenance costs. However, for reliable measurement with a TDL, necessary framework conditions such as minimum optical path length, availability of purge gas supply, or high dust load in a process can sometimes get in the way. Acknowledging these constraints, METTLER TOLEDO has developed specific adaption solutions to substantially increase the coverage of possible TDL applications.

The new wafer-type adaption allows cross-section installation down to DN50 (2") pipes with no flow restriction and minimum pipe work required. Further, static process gas conditions are not an obstacle to the GPro 500 with the availability of the new process purge-free probe for inertization and blanketing applications. Finally, the filter probe is ideal for measurement in high-dust applications where cross-stack-type TDLs typically fail due to the loss of signal intensity.



**New gases, new opportunities for process and combustion applications:**

**Oxygen:**

- Blanketing and inertization
- Combustion control
- Reformers
- Chlorination
- Flare stacks
- Thermal oxidizer
- Vapor recovery
- Formaldehyde

**CO:**

- Combustion
- ESP filter
- CO boiler
- FCC units

**CO<sub>2</sub>:**

- FCC units
- Ethylene oxide (EO)
- Ethylene
- PTA plant

**- Syngas**

- Ammonia
- Fired heaters
- Process heaters
- Carbon black
- Ethylene
- Hydrogen production

**CH<sub>4</sub>:**

- Syn gas

**CO/CH<sub>4</sub>:**

- Combustion

**H<sub>2</sub>O:**

- Chlorine gas
- H<sub>2</sub> reformer gas
- Tower dryer exhaust

**H<sub>2</sub>S:**

- Sulfur recovery

**NH<sub>3</sub>:**

- Ammonia slip

**HCl:**

- Stack monitoring



[www.mt.com/GPro500](http://www.mt.com/GPro500)

InPro 6800G/  
InPro 6850iG    InPro 6900iG    InPro 6950iG    GPro 500

Industrial Processes	InPro 6800G/ InPro 6850iG	InPro 6900iG	InPro 6950iG	GPro 500
<b>Chemical Industry</b>				
Inerting	•	•	•	•
Blanketing	•	•	•	•
Process / safety				•
Vapor recovery	•	•		•
Thermal oxidizer / process heaters				•
Flare				•
<b>Food and Beverage Industry</b>				
CO <sub>2</sub> recovery			•	
<b>Petrochemical</b>				
Flue gas				•
Flares				•
Process / safety				•
ESP filters				•
Combustion				•

Application guide for gas analyzers (for more application examples, visit [www.mt.com/GPro500-eBook](http://www.mt.com/GPro500-eBook))

## Comparison of Oxygen Measurement Technologies Selection Criteria to Help You Choose the Right Tool

**There is no single measurement technology that will work for every application. METTLER TOLEDO is dedicated to identifying and offering the best technologies for robust in process gas measurements. For making oxygen measurements, we have two technologies. The following is a general guideline for selecting the best technology. To make the final determination, please contact your local METTLER TOLEDO representative.**

### Oxygen measurement across the process industries

From preventing the build-up of explosive gas mixtures in chemical processes, to nitrogen blanketing for inhibiting product oxidation, to ensuring carbon dioxide purity in the Food and Beverage industry, measurement of oxygen is a vital element of many industrial processes.

### Amperometric

This is an electro-chemical measurement technology housed in a compact package. It is a depleting technology, some maintenance and consumables is required. Chemical interferences are possible; knowledge of the gas composition is required for evaluation.

For more information on this technique, refer to the Measurement Theory section of this catalog.

### Tunable Diode Laser (TDL)

METTLER TOLEDO's TDL technology is immune to most interferences and the sensor's materials of construction are quite robust. There is no regular maintenance and the sensor is designed for long term continuous operation while

being virtually drift free. TDL is suited for the most challenging and critical applications. The physical package is a bit larger than the amperometric and optical sensors. For more information on this technique, refer to the Measurement Theory section of this catalog.

	Amperometric	TDL Oxygen
<b>Applications</b>	Inerting & Blanketing	Process Control, Safety & Combustion
<b>Flow required</b>	No, great for tank inerting	Certain applications require flow
<b>Range</b>	5-50,000 ppm or 50 ppm to 60%	0.01 – 100%
<b>Max temperature</b>	70 °C (158 °F)	600 °C (1112 °F)
<b>Low pressure</b>	-0.81 bar (-11.8 psig)	-0.9 bar (-13.05 psig)
<b>High pressure</b>	+7.95 bar (115.3 psig)	+9 bar (130.53 psig)
<b>N<sub>2</sub> purging required</b>	No	Sometimes
<b>Maintenance, consumables</b>	Required	No
<b>Capital</b>	\$	\$\$\$
<b>Probe size</b>	Very small, for confined spaces	Larger, for pipes 2" dia. or larger
<b>Hazardous area technique</b>	Intrinsic safety	Explosion proof
<b>Background gas interference</b>	Susceptible to some	None
<b>SIL</b>	No	SIL2 compatible version available
<b>ATEX/FM Approved</b>	Yes	Yes

# TDL Gas Analyzers

For Every Installation Location in Your Plant



**Standard Purged    Wafer    Non-Purge    Non-Purged with filter and Blow-back    Extractive    Cross-Pipe**

<b>Optical Path Interface</b>	Insertion probe	Flow thru. Body is part of pipeline system	Insertion probe	Insertion probe	Extractive cell	Full diameter
<b>Min Flow Requirement</b>	Yes	Yes	No	Yes	No	Yes
<b>Process Interface/Size</b>	Mounts in pipe 4" diameter or larger	2", 150 lb ANSI or 3", 150 lb ANSI or 4", 150 lb ANSI	Mounts in pipe 4" diameter or larger	Mounts in pipe 4" diameter or larger	N/A	Pipes 1–3 m diameter
<b>Typical Application</b>	Near saturated gas stream e.g. combined gas vent line to destruct unit	Near saturated gas stream e.g. dryer, solvent, vapor recovery	Clean dry gases e.g. Storage tank safety blanket	Dry gases with particulate e.g. Flue gases	Clean dry gases from customer's extractive gas sampling system e.g. marine vapor recovery	Hot, flue gases, e.g. ammonia slip/ducts, and stacks

## Transmitter version

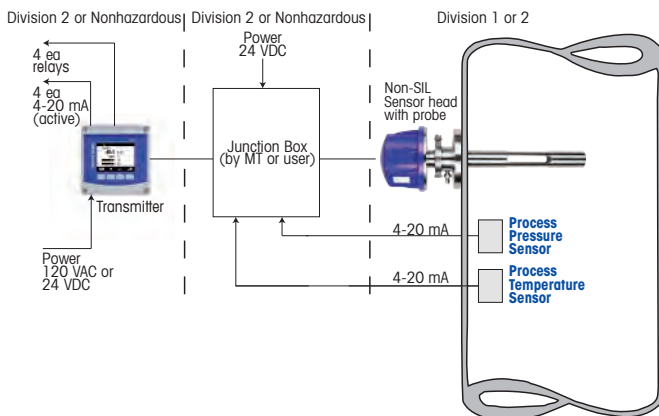

## Direct analog out version

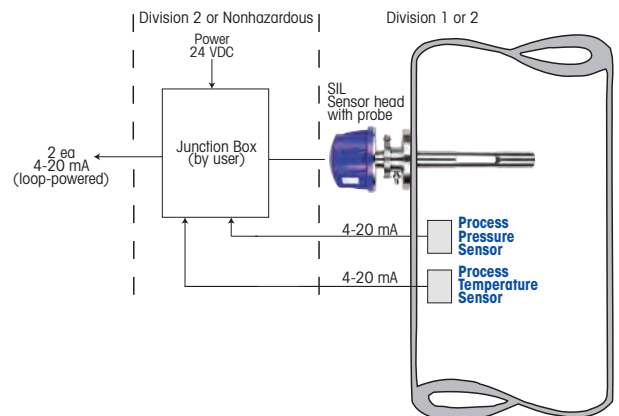

## GPro 500 TDL Building Your Measurement System

### Selection of Components

For proper operation and optimal performance in your process, each element of your measurement system must be carefully chosen. A complete measurement system requires components including a sensor, junction box, cable and transmitter.

### Sensor Selection

METTLER TOLEDO sensors are high performance and long lasting. However, proper selection must be made according to the application and process environment to which it will be exposed.

Basic selection considerations are:

- Gas to be measured
- Measurement range
- Operating temperature/pressure range
- Alarm level
- Accuracy required
- Background gases & concentrations
- Ambient temperature
- Contaminants (particulates, oils, condensate, aerosols)
- Piping/vessel sizes
- Gas stream velocity
- Dust and particle content

The sensor is made up of two significant pieces, as discussed below:

#### 1a. Sensor-Spectrometer Portion (head)

Once it has been determined that we can successfully make the desired measurement, selection of correct head is relatively simple

Choices include:

- Gas to be measured (presently O<sub>2</sub>, CO, CO<sub>2</sub>, HCl, H<sub>2</sub>S, CH<sub>4</sub>, CO/CH<sub>4</sub>, CH<sub>4</sub>, NH<sub>3</sub> and H<sub>2</sub>O vapor)
- Safety approval type (FM or ATEX)
- Requirement for SIL2

#### 1b. Sensor – Process Adaption Portion

Upon detailed review of the process conditions and using our many years of experience, we select the best style adaption for the application and the appropriate size.

This is a brief summary of the process adaption styles (each available in various sizes):

- Purged probe
- Non-purged probe
- Non-purged probe with filter and optional blowback
- Wafer
- Extractive
- White cell

In addition to the sensor style and size, other decisions include:

- Seal material (Kalrez® types or graphite)
- Optic material (borosilicate glass, quartz or sapphire)
- Wall thickness (to accommodate wall insulation)
- Process connection size
- Material of construction: 316L stainless steel and C22 Hastelloy are standard; others are available on request.



## 2. Transmitter Selection

Transmitters are the component that communicates a sensor's readings into displayed measurements. The transmitter also transfers the data to the process control system.

Most users want the convenience of having a local display, multiple analog inputs/outputs and alarms. For these users we select the model M400, Type 3 transmitter. This 4 wire transmitter is ATEX/FM approved for Zone/Division 2 areas, is suitable for indoor or outdoor use and can be powered from AC or DC.

If your site requires a SIL version of the GPro 500, that version does not utilize the separate (M400) transmitter. The SIL version of the GPro 500 has a simple transmitter built into the sensor's head. It does not have the functionality of the M400, it simply has 2 analog (4–20mA) signal outputs (loop powered).

## 3. Junction Box

The multi-core cable that connects on one end to the GPro 500 head terminates the other end at a junction box that houses a 16 position terminal strip. METTLER TOLEDO offers a junction box or users can provide their own junction box. The junction box needs to be rated for the area where it will be installed.

## 4. Cable

A multi-core cable is used to connect the GPro 500 head to the junction box. Note: on the FM unit, the cable is shipped loose, the ATEX unit has the cable pre-terminated in the sensor's head.

## 5. Verification Cell

Although not part of the GPro 500, a verification cell is a useful tool to verify calibration and for troubleshooting.

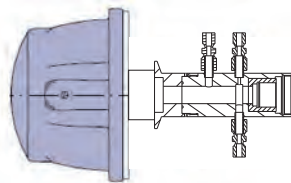

To use the cell, remove the sensor head from the probe and connect the cell to the head using the Tri-Clamp and special gasket. One verification cell can be used for multiple units on the same site. Ambient air can be used as a check gas for the oxygen sensor. To introduce other gases, the cell has inlet and outlet fittings.

## 6. Diagnostic Software

The MT TDL Suite is PC software with a variety of functions to see into and capture information about the operation of your GPro 500. It is not mandatory to ever use this software but most users find it a powerful tool. The software suite will automatically detect the gas that your unit is designed to measure and will display it appropriately.



## 7. Thermal Barrier

If the process gas is expected to be at a temperature between 250 °C to 600 °C, a thermal barrier can be used to protect the sensor's electronics. The thermal barrier is effectively a spool piece mounted between the sensor and the sensor head.

## GPro 500 Sensor

In Situ Sensor Convenience, with the Power of an Analyzer



Tunable Diode Laser (TDL) measurement technology is recognized for speed and accuracy of measurement, and immunity to background gases. To this, METTLER TOLEDO has added the simplicity of use and low maintenance of in-line sensor design, plus advanced predictive diagnostics. The result is the GPro 500 series, a highly durable line of oxygen sensors for process and safety applications in chemical plant and petrochemical operations.

### Specifications

#### Measurement O<sub>2</sub>

Effective path length	Probes: 200, 400, 800 mm (7.87", 15.75", 31.49")
	Water: 50, 80, 100 mm (1.96", 3.15", 3.94")
	Extractive cells: 200, 400, 800 mm, 1 m, (7.87", 15.75", 31.49", 39.37")
Lower detection limit (in 1 meter path length at ambient standard conditions, dry gas, no dust load, in N <sub>2</sub> background)	100 ppm-v
Measurement range	0–100%
Accuracy	2% of reading or 100 ppm O <sub>2</sub> , whichever is greater
Linearity	Better than 1%
Resolution	<0...0.01% vol O <sub>2</sub> (100 ppm-v)
Sampling rate	1 second
Response time (T <sub>90</sub> )	O <sub>2</sub> in N <sub>2</sub> 21% >0% in <2 sec
Warm up time	Typically <1 minute
Repeatability	±0.25% of reading or 0.05% O <sub>2</sub> (whichever is greater)
Process pressure range	0.1 bar–10 bar (abs)* / 1.45 psi–145.03 psi (abs)
Process temperature range	0–250 °C (32–482 °F) Optional (for probe installation) 0–600 °C (0–1112 °F) with additional thermal barrier

\* firmware 6.23 or higher

### Features Overview

- One-flange installation without alignment
- In situ measurement without sampling system
- Low cost-of-ownership with virtually no maintenance
- Low purge gas consumption for minimum operating costs
- Large choice of process interface options



### Did You Know

Tunable Diode Laser spectrometers are insensitive to background interference from the process gas and moisture, and are largely resistant to heavy dust loads.

▶ [www.mt.com/GPro500](http://www.mt.com/GPro500)



**Measurement (All measurement specifications with reference to standard conditions T & P with no dust or particulates) and 1 m optical path**

	O <sub>2</sub>	CO (ppm)	CO (%)	H <sub>2</sub> O	H <sub>2</sub> O ppm	CO <sub>2</sub> (%)
Effective path length	<b>Probes:</b> 200, 400, 800 mm (7.87", 15.75", 15.75", 31.50"). <b>Wafer Cell:</b> 104 mm, 110 mm, 154 mm, 164 mm, 214 mm (4.09", 4.33", 6.06", 6.46", 8.43") <b>Extractive cells:</b> 200 mm, 400 mm, 800 mm, 1 m, 8 m (7.87", 15.75", 31.50", 39.37", 315")					
Measurement range and standard conditions <sup>1)</sup>	0–100%	0–2%	0–100%	0–20%	0–1%	0–100%
Lower Detection Limit <sup>2)</sup>	100 ppm-v	1 ppm-v	1500 ppm-v	5 ppm-v	1 ppm-v	1000 ppm-v
Accuracy	1% of reading or 100 ppm O <sub>2</sub> , whichever is greater	2% of reading or 1 ppm, whichever is greater	2% of reading or 1500 ppm, whichever is greater	2 % of reading or 10 ppm, whichever is greater	2% of reading or 1 ppm, whichever is greater	2% of reading or 1000 ppm, whichever is greater
Linearity	Better than 1%	Better than 1%	Better than 1%	Better than 1%	Better than 1%	Better than 1%
Sampling rate	1 second	1 second	1 second	1 second	1 second	1 second
Response time (T90)	O <sub>2</sub> in N <sub>2</sub> 21% >0% in <2 sec	CO in N <sub>2</sub> 300 ppm-v to 0% in <4 sec	CO in N <sub>2</sub> 1% to 0% in <4 sec	H <sub>2</sub> O in N <sub>2</sub> 1% to 0% in <4 sec	H <sub>2</sub> O in N <sub>2</sub> 1% to 0% in <4 sec	CO <sub>2</sub> in N <sub>2</sub> 1% to 0% in <4 sec
Warm-up time	Typically <1 hour	Typically <1 hour	Typically <1 hour	Typically <1 hour	Typically <1 hour	Typically <1 hour
Repeatability	±0.25% of reading or 0.05% O <sub>2</sub> , whichever is greater	±0.25% of reading or 5 ppm-v CO, whichever is greater	±0.25% of reading or 0.75%-v CO, whichever is greater	±0.25% of reading or 50 ppm-v H <sub>2</sub> O, whichever is greater	±0.25% of reading or 10 ppm-v H <sub>2</sub> O, whichever is greater	±0.25% of reading or 5000 ppm-v CO <sub>2</sub> , whichever is greater
Process pressure range	0.1 bar to 10 bar (abs)*/ 1.45 psi to 145.03 psi (abs)*	0.8 bar to 2 bar (abs)/ 11.6 psi to 29.psi (abs)	0.8 bar to 1.5 bar (abs)/ 11.6 psi to 21.7.psi (abs)	0.8 bar to 2 bar (abs)/ 11.6 psi to 29.psi (abs)	0.8 bar to 5 bar (abs)/ 11.6 psi to 72.5 psi (abs)	0.8 bar to 2 bar (abs)/ 11.6 psi to 29 psi (abs)
Process temperature range	0 to +250 °C (+32 to +482 °F) Standard. 0 to +600 °C (0 to +1112 °F) with built in thermal barrier. 0 to +150 °C (+32 to +302 °F) (PFA, PTFE filter)					
* firmware 6.23 or higher						

	CO ppm/CH <sub>4</sub> %	CO <sub>2</sub> %/CO %	HCl (ppm)	H <sub>2</sub> S (%)	CH <sub>4</sub> ppm	NH <sub>3</sub> ppm
Effective path length	<b>Probes:</b> 200, 400, 800 mm (7.87", 15.75", 15.75", 31.50"). <b>Wafer Cell:</b> 104 mm, 110 mm, 154 mm, 164 mm, 214 mm (4.09", 4.33", 6.06", 6.46", 8.43") <b>Extractive cells:</b> 200 mm, 400 mm, 800 mm, 1 m, 8 m (7.87", 15.75", 31.50", 39.37", 315")					
Measurement range and standard conditions <sup>1)</sup>	0–2% (CO) 0–10% (CH <sub>4</sub> )	0–100% (CO <sub>2</sub> and CO)	0–3%	0–50%	0–1 %	0–1 %
Lower Detection Limit <sup>2)</sup>	0–200°C: 1 ppm-v (CO), 5 ppm-v (CH <sub>4</sub> ) 200–600°C: 5 ppm-v (CO), 25 ppm-v (CH <sub>4</sub> )	1000 ppm-v (CO <sub>2</sub> ) 1500 ppm-v (CO)	0.6 ppm-v	20 ppm-v	1 ppm-v	1 ppm-v
Accuracy	2% of reading or 1 ppm (CO)/25 ppm-v (CH <sub>4</sub> ), whichever is greater	2% of reading or 1000 ppm, whichever is greater	2% of reading or 0.6 ppm, whichever is greater	2% of reading or 20 ppm, whichever is greater	2 % or 1 ppm	2 % or 1 ppm
Linearity	Better than 1%	Better than 1%	Better than 1%	Better than 1%	Better than 1%	Better than 1%
Sampling rate	1 second	1 second	1 second	1 second	1 second	1 second
Response time (T90)	CO/CH <sub>4</sub> in N <sub>2</sub> 2% to 0% in <4 sec	CO <sub>2</sub> in N <sub>2</sub> 1% to 0% in <4 sec	HCl in N <sub>2</sub> 1% to 0% in <4 sec	H <sub>2</sub> S in N <sub>2</sub> 1% to 0% in <4 sec	CH <sub>4</sub> in N <sub>2</sub> 1% to 0% in <4 sec	NH <sub>3</sub> in N <sub>2</sub> 1% to 0% in <4 sec
Warm-up time	Typically <1 hour	Typically <1 hour	Typically <1 hour	Typically <1 hour	Typically <1 hour	Typically <1 hour
Repeatability	±0.25% of reading or 5 ppm-v CO/500 ppm-v CH <sub>4</sub> , whichever is greater	±0.25% of reading or 5000 ppm-v CO <sub>2</sub> or CO, whichever is greater	±0.25% of reading or 3 ppm-v HCl, whichever is greater	±0.25% of reading or 100 ppm-v H <sub>2</sub> S, whichever is greater	±0.25% of reading or 5 ppm-v CH <sub>4</sub> , whichever is greater	±0.25% of reading or 5 ppm-v NH <sub>3</sub> , whichever is greater
Process pressure range	0.8 bar to 2 bar (abs)/ 11.6 psi to 29 psi (abs)	0.8 bar to 2 bar (abs)/ 11.6 psi to 29 psi (abs)	0.8 bar to 3 bar (abs)/ 11.6 psi to 43.5 psi (abs)	0.8 bar to 2 bar (abs)/ 11.6 psi to 29 psi (abs)	0.8 bar to 3 bar (abs)/ 11.6 psi to 43.5 psi (abs)	0.8 bar to 3 bar (abs)/ 11.6 psi to 43.5 psi (abs)
Process temperature range	0 to +250 °C (+32 to +482 °F) Standard. 0 to +600 °C (0 to +1112 °F) with built in thermal barrier. 0 to +150 °C (+32 to +302 °F) (PFA, PTFE filter)					

<sup>1)</sup> Measurement range and standard conditions (ambient temperature and pressure, 1 m path length).

<sup>2)</sup> Lower Detection Limit (in 1 meter path length at ambient standard conditions, dry gas, no dust load, in N<sub>2</sub> background).

# Gas Analyzers

Measure Everywhere It Matters

## Variant Configurator

Gas Analyzer	GPro 500	A	T	A	O	P	B	K	S	O	2	O	P	D	1	X	S	_	_	/	A	X
30 027 126*, 30 538 717**	GPro 500	Y	Y	Y	Y	Y	Y	Y	Y	Y	Y	Y	Y	Y	Y	Y	Y	Y	Y	/	Y	Y
<b>Hazardous area approvals</b>																						
ATEX/IECEX Ex d		A	T																			
FM Class 1 Div 1		U	S																			
<b>Gases</b>																						
Oxygen				A	O																	
CO				C	O																	
H <sub>2</sub> O				H	O																	
H <sub>2</sub> O ppm				H	1																	
CO <sub>2</sub> %				C	2																	
CO %				C	1																	
CO % + CO <sub>2</sub> %				C	C																	
CO ppm + CH <sub>4</sub> %				C	M																	
H <sub>2</sub> S				S	1																	
HCl ppm				L	O																	
CH <sub>4</sub> ppm				M	O																	
NH <sub>3</sub> ppm				N	O																	
<b>Process interfaces</b>																						
Standard Probe purged (SP)						P																
Standard Probe purged twin (SP)						T																
Non-purged Filter Probe (NP)						F																
Non-purged Filter Probe twin (NP)						R																
Non-purged Filter Probe with Blow-back (BP)						B																
Non-purged Filter Probe with Blow-back twin						U																
Wafer (W)						W																
Extractive Cell (E)						E																
Cross-pipe Folded Path (C)						C																
<b>Process optics***</b>																						
Borosilicate						B																
Quartz						Q																
Sapphire						S																
Dual Window Borosilicate						C																
Dual Window Quartz						R																
Dual Window Sapphire						T																
<b>Process sealings***</b>																						
Kalrez® 6375							K															
Graphite							G															
Kalrez® (FDA grade) 6230							F															
Kalrez® 6380							S															
Kalrez® 0090							R															
EPDM FDA							Q															
<b>Wetted materials***</b>																						
1.4404 (equivalent to 316L)								S	O													
Hastelloy C22								C	O													
<b>Optical path probes and extractive cell***</b>																						
200 mm (7.9")										2	0											
400 mm (15.7")										4	0											
800 mm (31.5")										8	0											
1 m (3.3 ft)										0	1											
2 m (6.6 ft)										0	2											
3 m (9.8 ft)										0	3											
4 m (13.1 ft)										0	4											

**Variant Configurator (continued)**

Gas Analyzer	GPro 500	A	T	A	O	P	B	K	S	O	2	O	P	D	1	X	S	_	_	/	A	X
30 027 126*, 30 538 717**	GPro 500	Y	Y	Y	Y	Y	Y	Y	Y	Y	Y	Y	Y	Y	Y	Y	Y	Y	Y	/	Y	Y
5 m (16.4 ft)												0	5									
6 m (19.7 ft)												0	6									
None												X	X									
<b>Process connections***</b>																						
DN50/PN25																	P	D				
ANSI 2"/300 lbs																	P	A				
DN50/PN16																	L	D				
ANSI 2"/150 lbs																	L	A				
DN80/PN16																	G	D				
ANSI 3"/150 lbs																	G	A				
DN100/PN25																	N	D				
ANSI 4"/300 lbs																	N	A				
ANSI 4"/150 lbs																	M	A				
DN50/PN16 and 40																	W	1				
DN80/PN16 and 40																	W	2				
DN100/PN16																	W	3				
ANSI 2"/150 lbs																	W	4				
ANSI 3"/150 lbs																	W	5				
ANSI 4"/150 lbs																	W	6				
Swagelok 6 mm																	E	M				
Swagelok ¼"																	E	I				
<b>Wall thickness***</b>																						
100 mm																					1	
200 mm																						2
300 mm																						3
None																						X
<b>Filters***</b>																						
Filter A – 40 µm																						A
Filter B – 100 µm																						B
Filter C – 200 µm																						C
Filter D – 3 µm																						D
Filter PTFE Membrane																						E
No Filter																						X
<b>Add-on modules***</b>																						
None																						X
With Thermal Barrier (up to 600 °C)																						H
2-fold Multireflection Cell																						2
3-fold Multireflection Cell																						3
<b>Cable</b>																						
5 m (16.4 ft)																						A
15 m (49.2 ft)																						B
25 m (82.0 ft)																						C
40 m (131.2 ft)																						D
None																						X
<b>Communication interfaces</b>																						
RS485 (for M400)																						X
RS485 and Direct Analog (SIL)																						A

\* 6 weeks delivery time. \*\* 3 weeks delivery time. \*\*\* Other configurations upon request.

## InPro 6000 G Sensor Series

### Oxygen Control for Your Gas Applications



#### Features Overview

- True in-line measurement without gas sampling system
- Long lasting and easy to maintain membranes
- Certified for hazardous gaseous and dust areas
- Oxygen measurement is not affected by water, water vapors or most organic solvents

#### Other Highlights

- Membrane covered amperometric measurement technology allows direct in-line installations
- Sensor can easily be calibrated in air. Costly calibration gases are eliminated

The InPro 6000 G O<sub>2</sub> sensor series for gas measurement provides high operational availability together with excellent measurement performance. Without the need for expensive gas sample conditioning, the sensor can be installed directly in the process, and sensor maintenance or replacement can be performed without process interruption. METTLER TOLEDO offers a unique easy-to-use and reliable solution for challenging applications like N<sub>2</sub> blanketing, inertization and off-gas monitoring in Ex or non-Ex applications.

#### Specifications

##### Performance

Operating range	InPro 6800G/6850iG:	0.1 Vol-% O <sub>2</sub> to 100 Vol-% O <sub>2</sub>
	InPro 6900iG:	50 ppm to 60 Vol-% O <sub>2</sub>
	InPro 6950iG:	5 ppm to 50,000 ppm
Accuracy	InPro 6800G/6850iG:	≤ ± [1 % + 0.1 Vol-%]
	InPro 6900iG:	≤ ± [1 % + 50 ppm]
	InPro 6950iG:	≤ ± [1 % + 5 ppm]
Response time at 25 °C (77 °F) (N <sub>2</sub> → 15 Vol-% O <sub>2</sub> )		90 % of the signal in <20
Sensor signal in air at 25 °C (77 °F)	InPro 6800G/6850iG:	50 to 110 nA
	InPro 6900iG:	250 to 500 nA
	InPro 6950iG:	2500 to 6000 nA

##### Construction

Measuring principle	Amperometric Clark electrode
Cable connection	Analog VarioPin (IP68), Digital K8S (IP68)
Connector design	Straight
Process connection	Pg 13.5
Sensor diameter	12 mm
Sensor body	316L stainless steel C22 (titanium on request)
Membrane material	PTFE/Silicone (reinforced with steel mesh)
Surface roughness of wetted parts	N5/R <sub>a</sub> 16 (R <sub>a</sub> =0.4 μm/ 16 μin)
O-ring material	Silicone or Kalrez®

##### Working Conditions

Temperature compensation	Automatic
Measuring temperature range	0 to 70 °C (32 to 158 °F)
Environmental temperature range	-5 to 121 °C (23 to 249.8 °F)
Operating pressure	0.2 to 9 bar (2.9 to 130 psi absolute)
Design pressure	Maximum 12 bar (174 psi absolute)

##### Certificates and Approvals

METTLER TOLEDO Quality Certificate, EHEDG, FDA/USP Class VI, 3.1, N5/R<sub>a</sub>16,  
ATEX: Ex ia IIC T6/T5/T4/T3 Ga/Gb,  
Ex ia IIIC T69 °C/T81 °C/T109 °C/T161 °C Da/Db  
FM: IS Cl. I, II, III, Div 1, GR ABCDEFG/T6\*

##### Intelligent Sensor Management (ISM)

InPro 6000iG sensors with integrated ISM functionality allow Plug and Measure and advanced diagnostics. ISM simplifies the installation, handling and maintenance of measurement equipment. For more information see ISM introduction pages 10–11.

► [www.mt.com/O2-gas](http://www.mt.com/O2-gas)



## Ordering Information

12 mm InPro 6800G Oxygen Sensors	Length	Connector Style	Order Number
InPro 6800G/12/120	120 mm	Straight VP	52 206 425
InPro 6800G/12/220	220 mm	Straight VP	52 206 426
InPro 6800G/12/120/Ka	120 mm	Straight VP	52 206 427
InPro 6800G/12/220/Ka	220 mm	Straight VP	52 206 428
InPro 6800G/12/120/C22	120 mm	Straight VP	52 206 429
InPro 6800G/12/220/C22	220 mm	Straight VP	52 206 430
12 mm InPro 6850 iG Oxygen Sensors			
InPro 6850iG/12/120	120 mm	Straight K8S	52 206 431
InPro 6850iG/12/220	220 mm	Straight K8S	52 206 432
InPro 6850iG/12/120/Ka	120 mm	Straight K8S	52 206 433
InPro 6850iG/12/220/Ka	220 mm	Straight K8S	52 206 434
InPro 6850iG/12/120/C22	120 mm	Straight K8S	52 206 435
InPro 6850iG/12/220/C22	220 mm	Straight K8S	52 206 436
12 mm InPro 6900 iG Oxygen Sensors			
InPro 6900iG/12/120	120 mm	Straight K8S	52 206 437
InPro 6900iG/12/220	220 mm	Straight K8S	52 206 438
InPro 6900iG/12/120/Ka	120 mm	Straight K8S	52 206 439
InPro 6900iG/12/220/Ka	220 mm	Straight K8S	52 206 440
12 mm InPro 6950 iG Oxygen Sensors			
InPro 6950iG/12/120	120 mm	Straight K8S	52 206 443
InPro 6950iG/12/220	220 mm	Straight K8S	52 206 444

## Consumables

Designation	Order Numbers			
	InPro 6800G	InPro 6850 iG	InPro 6900 iG	InPro 6950 iG
Membrane body, single T-Type	52 201 151	52 206 453	52 206 459	52 206 465
Membrane body, single T-Type Ka (Kalrez® O-ring)	52 201 158	52 206 455	52 206 461	–
Membrane body, single T-Type C22 (Kalrez® O-ring, wetted part C22)	52 201 163	52 206 457	–	–
Membrane kit T-Type*	52 201 149	52 206 454	52 206 460	52 206 466
Membrane kit T-Type Ka**	52 201 159	52 206 456	52 206 462	–
Membrane kit T-Type C22***	52 201 164	52 206 458	–	–
Replacement anode/cathode assembly	52 206 449	52 206 450	52 206 451	52 206 452
O <sub>2</sub> electrolyte pack (3 × 25 ml)	30 298 424	30 298 424	–	–
InPro 6900 electrolyte pack (3 × 5 ml)	–	–	30 298 425	–
InPro 6950 electrolyte pack (3 × 5 ml)	–	–	–	30 298 426

\* 4 membranes, 1 O-ring set silicone, 25 ml electrolyte (InPro 69XXiG models: 2 × 5 ml electrolyte), wetted parts SS 316 L

\*\* 4 membrane, 1 O-ring set Kalrez®, 25 ml electrolyte (InPro 69XXiG models; 2 × 5 ml electrolyte), wetted parts SS 316 L

\*\*\* 4 membranes, 1 O-ring set Kalrez®, 25 ml electrolyte, wetted parts C22 (Hastelloy)

## Accessories

Designation	Order Number
O <sub>2</sub> Sensor Master digital ISM	52 206 329
InPro 6800 Sensor Master	52 200 892



### Did You Know

The InPro 6000G with ISM series feature a built-in electrolyte level monitor that signals the user when refilling is required.

O<sub>2</sub> sensor master



Replacement anode/cathode assembly of InPro 6950 iG



Membrane Body  
InPro 6800G



Membrane Body  
InPro 6850 iG

### Suitable Housings

	p.
InFit 761 e.....	122
InFlow .....	128
InTrac 777 e.....	133
InTrac 797 e.....	134
InTrac 781 .....	135





# Process Analytics Measurement Solutions for Industrial and Pure Water Applications

# Conductivity/Resistivity Systems

## When Optimal Performance Is Essential

**Electrolytic conductivity is a widely used analytical parameter for water purity analysis, monitoring of reverse osmosis, cleaning procedures, control of chemical processes, and in industrial wastewater.**

### Three commonly used techniques

Electrolytic conductivity is a measure of the total ionic content of a solution. There are three main methodologies to measure conductivity:

- 2-electrode sensors are for measurements in high purity water and relatively low conductivity ranges
- 4-electrode sensors are for mid to high ranges. They are more resistant to fouling than 2-electrode designs
- Inductive sensors cover mid to very high conductivity ranges, and are particularly resistant to fouling.

METTLER TOLEDO offers all three methodologies.

### 2-electrode sensor design

An AC voltage is applied across the two electrodes, and the resistance between them is measured. The built-in temperature sensor provides fast accurate measurement. The cell geometry and the high solution resistance allow for very accurate and precise conductivity determination.

Sensors are used for water conditioning and purification stages where they are capable of detecting minute levels of impurities in ultrapure water.

### 4-electrode sensor design

An AC voltage is applied across the two outside electrodes. The principle is to measure the voltage drop across the two inner electrodes. Therefore, polarization errors are eliminated. Since this technique measures potential drop, the measurement remains accurate. It permits easier in-line cleaning and it can be installed in smaller piping than inductive sensors.

These sensors are used for concentration measurement of acids, alkalis, and salt process streams.



58 031 404



58 031 242



58 031 423



58 031 201



## Application guide for conductivity sensors

**Thornton sensors**  
 NPT titanium 0.1 cm<sup>2</sup> sensors  
 Sanitary 316L SS 0.1 cm<sup>2</sup> sensors  
 NPT CPVC & PEEK 4-E sensors  
 Sanitary PEEK 4-E sensors

Where to use	NPT titanium 0.1 cm <sup>2</sup> sensors	Sanitary 316L SS 0.1 cm <sup>2</sup> sensors	NPT CPVC & PEEK 4-E sensors	Sanitary PEEK 4-E sensors
Pure and ultrapure water	•	•		
Sanitary		•		•
Water purification	•			
SIP		•		•
Industrial wastewater			•	
Medium/high conductivity			•	•
Aggressive chemicals			•	
Chemical applications			•	
Pharmaceutical water		•		
High conductivity			•	•
Chemical concentration			•	•

### UniCond™ Conductivity/Resistivity Sensors with ISM

The UniCond conductivity/resistivity sensor advancement integrates the measuring circuit and the physical sensor into a single unit. UniCond conductivity/resistivity sensors provide exceptionally wide measurement ranges due to their advanced built-in measuring circuit. The on-board measuring circuit eliminates interference from lead wire resistance and capacitance. Only digital signals go back to the transmitter. The UniCond design mitigates the effects of polarization, enabling the upper range of the conductivity sensor to be greatly expanded. UniCond 2-electrode sensors provide the ability to accurately measure from ultrapure water to brackish water (up to 50,000 µS/cm) with a single integrated sensor, greatly simplifying water treatment instrumentation. UniCond 4-electrode sensors measure up to 1 S/cm.

### Inductive Sensors (see page 84–85)

### Continuous conductivity monitoring of pharmaceutical waters

USP guideline <645> sets a standard for the quality assessment of USP waters based on measurement of the electrolytic conductivity. There is a 3-stage test in which stage 1 allows on-line, non-temperature compensated conductivity measurement. There are specific requirements for the sensors and transmitters (see table below). Thornton instruments fulfill all these and other pharmacopeia requirements. In addition, Thornton instruments provide USP and EP setpoints for convenience.

Specification	USP <645>
Conductivity sensor and cell constant accuracy	Verify cell constant within ± 2 % using a reference solution
Resistance measurement circuit	NIST traceable 0.1 % precision resistors in place of sensor
Instrument resolution	0.1 µS/cm
Instrument accuracy at 1.3 µS/cm	0.1 µS/cm
Temperature compensation	Must be read uncompensated
Instrument dynamic range	10 <sup>2</sup>

METTLER TOLEDO instruments meet USP <645> and other pharmacopeia water conductivity requirements

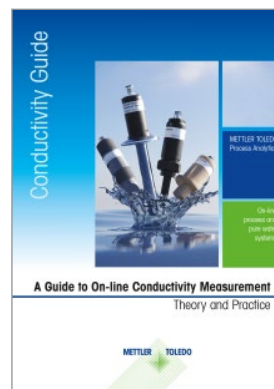

Find out more in our comprehensive conductivity theory guide at [www.mt.com/conductivity-guide](http://www.mt.com/conductivity-guide)

## UniCond Conductivity/Resistivity Sensors with ISM Certified Calibration for Compliance



UniCond conductivity/resistivity sensors provide exceptionally wide measurement ranges due to their advanced built-in measuring circuit. The on-board measuring circuit eliminates interference from leadwire resistance and capacitance. Only digital signals go back to the transmitter. Advanced measuring techniques further contribute to superior accuracy over the expanded range. ISM technology features pre-calibration Plug and Measure capabilities for fast, compliant start-up.

### Specifications

Accuracy	0.01 cm <sup>-1</sup> sensor: ± 1 %
	0.1 cm <sup>-1</sup> sensors: ± 1 % for 0.02–5,000 μS/cm; ± 3 % > 5,000 μS/cm
	4-E sensors: ± 4 %
Repeatability	± 0.25 %; ± 2 % for 4-E sensors
Temperature sensor	Pt 1000 RTD, IEC 60751, Class A, with NIST-traceable calibration
Temperature accuracy	± 0.1 °C at 25 °C; ± 0.5 °C for 4-E sensors
Maximum cable length	91 m (300ft)
Finish (Sanitary 0.1 cm <sup>-1</sup> sensors)	316 L SS is electropolished
Insulator material	PEEK except for the CPVC sensors
Response time	90 % of value in < 5 s
Connector	IP 65, mates with 58 080 27X series cable

**ISM**

### Features Overview

- Plug and Measure functionality
- Integral high-performance measuring circuit
- Robust digital output signal
- Calibration data stored internally
- Measuring circuit and system calibration can be performed in-line
- Simple compliance

### Other Highlights

- Extremely wide rangeability: ultrapure to sea water
- Highest accuracy
- NPT and Tri-Clamp connections



[www.mt.com/UniCond](http://www.mt.com/UniCond)

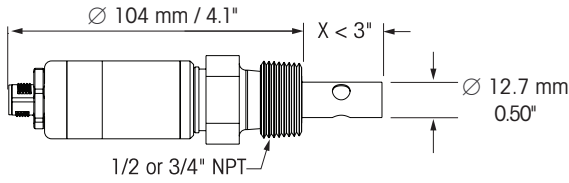

UniCond NPT 0.01 and 0.1 constant conductivity sensors

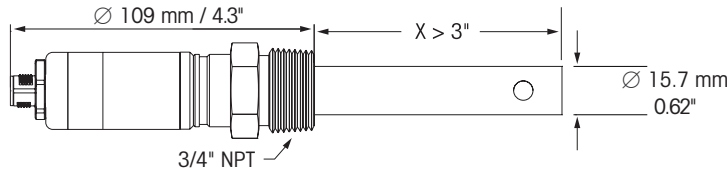

UniCond NPT 0.1 constant conductivity sensors

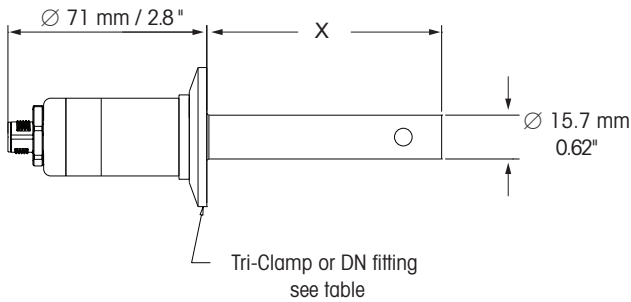

UniCond sanitary 0.1 constant conductivity sensor

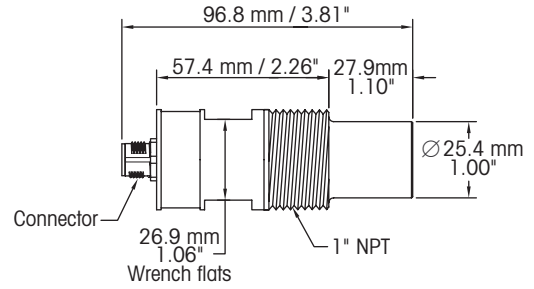

UniCond NPT PEEK conductivity sensors

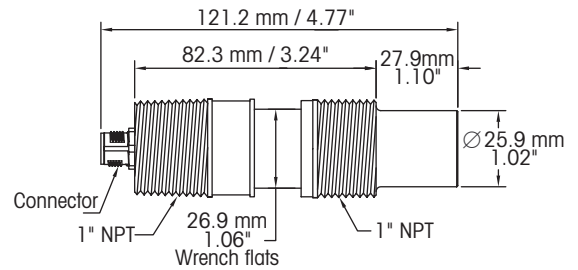

UniCond NPT CPVC conductivity sensors

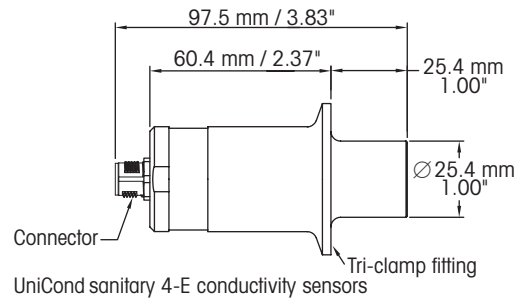

UniCond sanitary 4-E conductivity sensors

## Ordering Information

Description							Order Number
Fitting	Insertion Length "X" mm (inch)	Fitting/Body material	Range ( $\mu\text{S}/\text{cm}$ ) *	Cell Const. ( $\text{cm}^{-1}$ )	Electrode Material	Max Pressure at Temp bar (psig) at °C (°F)	
3/4" NPTM	34 (1.35)	PTFE/SS	0.01–50,000	0.1	Titanium	17 (250) at 93 (200)	58 031 404
3/4" NPTM	132 (5.19)	PTFE/SS	0.01–50,000	0.1	Titanium	17 (250) at 93 (200)	58 031 409
3/4" NPTM	34 (1.35)	PTFE/SS	0.01–50,000	0.1	Monel	17 (250) at 93 (200)	58 031 407
3/4" NPTM	132 (5.19)	PTFE/SS	0.01–50,000	0.1	Monel	17 (250) at 93 (200)	58 031 408
1/2" NPTM	29 (1.14)	PTFE/SS	0.01–50,000	0.1	Titanium	17 (250) at 93 (200)	58 031 406
3/4" NPT	60 (2.38)	PTFE/SS	0.001–500	0.01	Titanium	17 (250) at 93 (200)	58 031 410
1 1/2" Tri-Clamp	86 (3.38)	Titanium	0.01–50,000	0.1	Titanium		58 031 413 †
1 1/2" Tri-Clamp	55 (2.17)	316L SS	0.01–3,000	0.1	316L SS	14 (203) at 130 (266)	58 031 412 †
1 1/2" Tri-Clamp	86 (3.38)	316L SS	0.01–3,000	0.1	316L SS	& 31 (450) at 25 (77)	58 031 414 †
2" Tri-Clamp	105 (4.13)	316L SS	0.01–3,000	0.1	316L SS		58 031 415 †
1" NPTM	28 (1.1)	PEEK	10–1,000,000	4-E	Hastelloy	7 (100) at 93 (200) 14 (200) at 25 (77)	58 031 421
1" NPTM	28 (1.1)	CPVC	10–1,000,000	4-E	316L SS	3.5 (50) at 80 (176)	58 031 422
1" NPTM	28 (1.1)	CPVC	10–1,000,000	4-E	Hastelloy	7 (100) at 25 (77)	58 031 423
1 1/2" Tri-Clamp	25 (1.0)	PEEK	10–1,000,000	4-E	316L SS	4.8 (70) at 140 (284)	58 031 424 †
2" Tri-Clamp	25 (1.0)	PEEK	10–1,000,000	4-E	316L SS	14 (200) at 50 (122)	58 031 425 †
1 1/2" Tri-Clamp	25 (1.0)	PEEK	10–1,000,000	4-E	Hastelloy		58 031 426 †

\* Megohm-cm = 1/ $\mu\text{S}/\text{cm}$

† FDA compliant materials with certification to meet EN10204 3.1 & USP <88> Class VI

For conductivity sensors recommended services, see page 175.

## UPW UniCond Sensor Precise UPW Resistivity Measurement



The UPW UniCond™ sensor provides industry leading accuracy and an order of magnitude improvement in measurement stability, surpassing the standard currently set by other resistivity sensors in the SEMI industry. With the sensitivity to truly separate contamination from noise, the UPW UniCond sensor ensures measurement accuracy in even the most challenging semiconductor UPW applications with extremely high resistivity.

### Specifications

Accuracy	0.1 cm <sup>-1</sup> sensors: ± 0.5% for 10-20 MΩ -cm
Stability	0.003 MΩ-cm standard variation typical after rinse-up
Temperature sensor	Pt 1000 RTD, IEC 60751, Class A, with NIST-traceable calibration
Temperature accuracy	± 0.05 °C at 25 °C
Maximum cable length	91 m (300 ft)
Finish (Sanitary 0.1 cm <sup>-1</sup> sensors)	Ra 0.38 micrometers (8 microinches)
Response time	90% of value in <5s
Insulator material	PEEK
Connector	IP65, mates with 58 080 27X series cable

### Features Overview

- The UPW UniCond sensor offers unequalled temperature compensated resistivity accuracy to provide the clearest possible picture of your water quality.
- Enhanced METTLER TOLEDO Thornton resistivity measurement technology reduces signal noise from the UPW UniCond by 10× over other sensors in UPW.
- Robust construction and temperature compensation ensures that observed changes in resistivity are due to water quality and not environmental factors.
- Identification, calibration and maintenance data is stored in the UPW UniCond sensor, which allows for easy traceability. The sensor meets strict NIST-traceable calibration requirements.

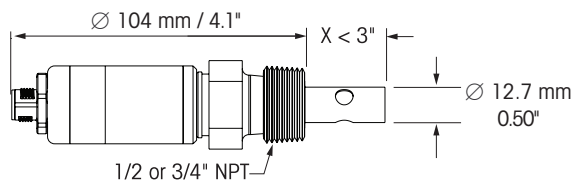

UniCond NPT 0.01 and 0.1 constant conductivity sensors

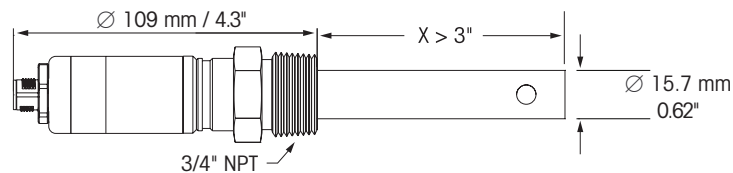

UniCond NPT 0.1 constant conductivity sensors

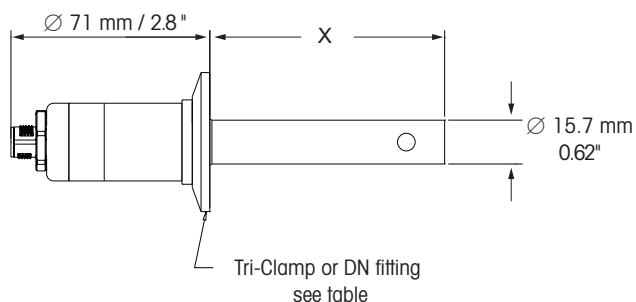

UniCond sanitary 0.1 constant conductivity sensor

### Ordering Information

Description							Order Number
Fitting	Insertion Length "X" mm (inch)	Fitting/Body material	Range (MΩ-cm) <sup>1</sup>	Cell Const. (cm <sup>-1</sup> )	Electrode Material	Max Pressure at Temp bar(g) (psig) at °C (°F)	
3/4" NPTM	34 (1.35)	PTFE/SS	10–20	0.1	Titanium	17 (250) at 93 (200)	30 819 342
3/4" NPTM	132 (5.19)	PTFE/SS	10–20	0.1	Titanium	17 (250) at 93 (200)	30 823 885
1 1/2" Tri-Clamp®	86 (3.38)	Titanium	10–20	0.1	Titanium	14 (203) at 130 (266) & 31 (450) at 25 (77)	30 823 886

\* MΩ-cm = 1/μS/cm

® Tri-Clamp is a registered trademark of Alfa Laval

For resistivity sensors recommended services, see page 175.

## Analog Conductivity Sensors

### A Comprehensive Series to Meet Industry Requirements



METTLER TOLEDO Thornton provides a full complement of analog conductivity/resistivity sensors with NPT or sanitary fittings. They include various lengths, cell constants and materials to match the application: titanium concentric electrodes for high purity water; monel electrodes for rinse waters containing HF; highly polished 316 L stainless steel (SS) electrodes for pharmaceutical waters; CPVC and PEEK sensors with four flush electrodes for solutions with higher conductivity and/or suspended material.

#### Specifications

Cell constant accuracy	± 1 %, except ± 5 % system accuracy for 4-electrode & 10 constant
Cell constant repeatability	± 0.25 %, except ± 2 % for 4-electrode & 10 constant
Temperature sensor	Pt 1000 RTD, IEC 60751, Class A
Temperature accuracy	± 0.1 °C (± 0.2 °F) at 25 °C (77 °F), except ± 0.5 °C (± 0.9 °F) for 4-electrode sensors
Cable jacket material	NPT: PVC, 80 °C (176 °F) rating Sanitary: PTFE, 200 °C (392 °F) rating
Max. sensor distance	60 m (200 ft), except 15 m (50 ft) for 244-Series
Finish, sanitary 0.1 cm <sup>-1</sup> sensors	R <sub>a</sub> < 0.2 μm/R <sub>a</sub> < 8 μin, 316 L SS is electropolished
Insulator material	PEEK (0.01 & 0.1 constant); Noryl (10 constant)

#### Features Overview

- Precise factory calibration and certification of each cell constant and RTD
- Optimized 4-wire measuring circuitry provides exceptional rangeability and accuracy, eliminating cable effects
- Quick and easy installation

#### Typical Applications

- Pharmaceutical water
- Power and steam generation
- Semiconductor water treatment
- Recycle and reclaim water
- Wastewater treatment

#### For detailed information about conductivity sensors for M300:

Please refer to pages 173–174 for ordering information and drawings



#### Sensor Selection Criteria

Thornton offers a wide variety of conductivity/resistivity sensors to accommodate most applications. Use the following criteria to select the appropriate sensor for your installation:

- Conductivity or resistivity range
- Transmitter
- Mounting type: insertion, retractable or submersion
- Pipe connection and size
- Chemical compatibility, including cleaning and disinfection processes
- Temperature requirements, including steam and/or hot chemical cleaning

► [www.mt.com/Thornton-Cond](http://www.mt.com/Thornton-Cond)

## Analog Conductivity Sensors

### Drawings

#### NPT 0.01 and 0.1 Constant

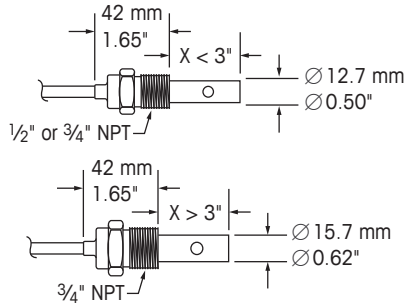

#### Sanitary, Standard

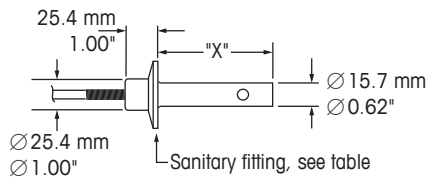

#### Sanitary, VP

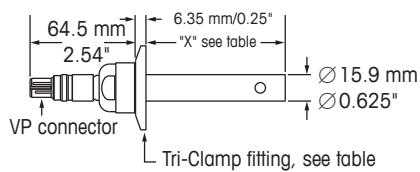

#### 316SS Flow Housing (58 084 000)

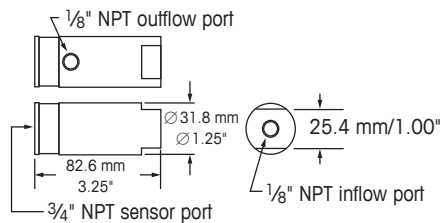

#### PVDF Flow Housing (58 084 001)

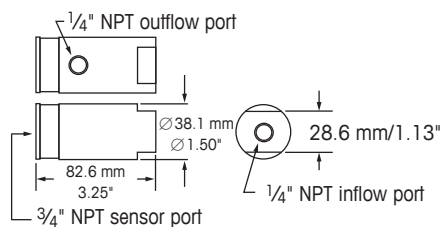

#### 316SS Flow Housing (58 084 016)

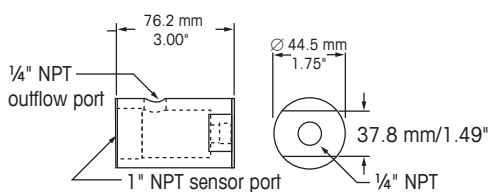

#### 10 Constant (58 031 241)

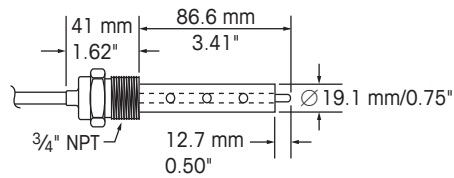

#### Submersion 0.1 Constant (58 031 207)

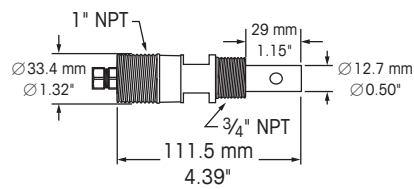

#### NPT 4-Electrode, CVPC

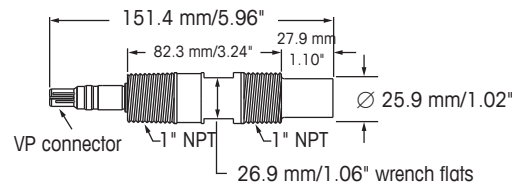

#### NPT 4-Electrode, PEEK

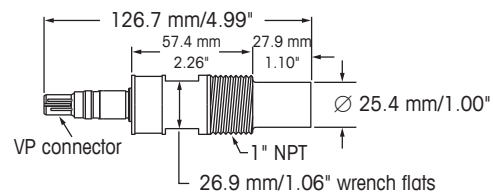

#### Sanitary 4-Electrode

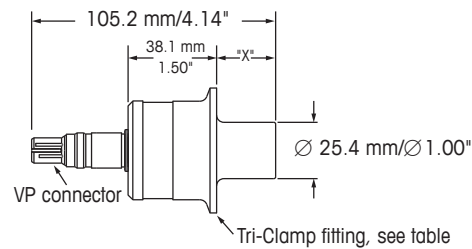

#### Boiler Water Conductivity Sensor

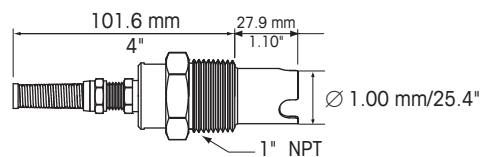

# Conductivity/Resistivity Sensors

Accurate and Reliable

Conductivity/Resistivity

## Ordering Information

Electrode Material	Maximum Pressure	Process Connection		Insertion Cable			Order Number
		- Fitting	- Material	Length "x"	Length	Connector	
<b>2-Electrode Sensors</b>							
<b>- Measuring range 0.02–2,000 µS/cm (cell constant 0.1 cm<sup>-1</sup>)<sup>a</sup></b>							
Titanium	17 bar(g) at 93 °C (250 psig at 200 °F)	¾" NPTM	PTFE/SS	34 mm (1.35")	0.5 m (1.5 ft)	S	58 031 201
Titanium	17 bar(g) at 93 °C (250 psig at 200 °F)	¾" NPTM	PTFE/SS	132 mm (5.19")	0.5 m (1.5 ft)	S	58 031 202
Monel	17 bar(g) at 93 °C (250 psig at 200 °F)	¾" NPTM	PTFE/SS	34 mm (1.35")	0.5 m (1.5 ft)	S	58 031 203
Monel	17 bar(g) at 93 °C (250 psig at 200 °F)	¾" NPTM	PTFE/SS	132 mm (5.19")	0.5 m (1.5 ft)	S	58 031 204
316 L SS	4 bar(g) at 131 °C (58 psig at 268 °F)	For	SS	70 mm (2.75")	-	VP	52 001 998
	7 bar(g) at 95 °C (100 psig at 203 °F)	Retractable					
	17 bar(g) at 25 °C (250 psig at 77 °F)	housing <sup>b</sup>					
Titanium	17 bar(g) at 93 °C (250 psig at 200 °F)	½" NPTM	Noryl	29 mm (1.14")	0.5 m (1.5 ft)	S	58 031 213
Titanium	17 bar(g) at 93 °C (250 psig at 200 °F)	¾" NPTM	Noryl	29 mm (1.14")	0.5 m (1.5 ft)	S	58 031 214
Titanium	17 bar(g) at 93 °C (250 psig at 200 °F)	¾" NPTM	PTFE/SS	34 mm (1.35")	3 m (10 ft)	S	58 031 215
Titanium	17 bar(g) at 93 °C (250 psig at 200 °F)	½" NPTM	PTFE/SS	29 mm (1.14")	0.5 m (1.5 ft)	S	58 031 216
Titanium	17 bar(g) at 93 °C (250 psig at 200 °F)	¾" NPTM	PTFE/SS	34 mm (1.35")	6.1 m (20 ft) <sup>c</sup>		58 031 217
Titanium	17 bar(g) at 93 °C (250 psig at 200 °F)	½" NPTM	PTFE/SS	29 mm (1.14")	3 m (10 ft) <sup>c</sup>		58 031 218
Titanium	17 bar(g) at 93 °C (250 psig at 200 °F)	¾" NPTM	PTFE/SS	34 mm (1.35")	9 m (30 ft) <sup>c</sup>		58 031 220
Titanium	10 bar(g) at 155 °C (150 psig at 311 °F)	1.5" Tri-Clamp	Titanium	86 mm (3.38")	0.5 m (1.5 ft)	S	58 031 221 <sup>d</sup>
	31 bar(g) at 25 °C (450 psig at 77 °F)						
316 L SS	10 bar(g) at 155 °C (150 psig at 311 °F)	1.5" Tri-Clamp	316 L SS	86 mm (3.38")	0.5 m (1.5 ft)	S	58 031 223 <sup>d</sup>
	31 bar(g) at 25 °C (450 psig at 77 °F)						
316 L SS	10 bar(g) at 155 °C (150 psig at 311 °F)	2" Tri-Clamp	316 L SS	105 mm (4.13")	0.5 m (1.5 ft)	S	58 031 227 <sup>d</sup>
	31 bar(g) at 25 °C (450 psig at 77 °F)						
Titanium	17 bar(g) at 93 °C (250 psig at 200 °F)	¾" NPTM	PTFE/SS	34 mm (1.35")	0.5 m (1.5 ft)	VP	58 031 232
Titanium	17 bar(g) at 93 °C (250 psig at 200 °F)	¾" NPTM	PTFE/SS	132 mm (5.19")	0.5 m (1.5 ft)	VP	58 031 233
316 L SS	10 bar(g) at 155 °C (150 psig at 311 °F)	1.5" Tri-Clamp	316 L SS	55 mm (2.17")	- VP		58 031 226 <sup>d</sup>
	31 bar(g) at 25 °C (450 psig at 77 °F)						
316 L SS	10 bar(g) at 155 °C (150 psig at 311 °F)	1.5" Tri-Clamp	316 L SS	85 mm (3.35")	- VP		58 031 234 <sup>d</sup>
	31 bar(g) at 25 °C (450 psig at 77 °F)						
316 L SS	10 bar(g) at 155 °C (150 psig at 311 °F)	2" Tri-Clamp	316 L SS	104 mm (4.10")	- VP		58 031 235 <sup>d</sup>
	31 bar(g) at 25 °C (450 psig at 77 °F)						
<b>- Measuring range 0.002–200 µS/cm (cell constant 0.01 cm<sup>-1</sup>)<sup>a</sup></b>							
Titanium	17 bar(g) at 93 °C (250 psig at 200 °F)	¾" NPTM	PTFE/SS	60 mm (2.38")	0.5 m (1.5 ft)	S	58 031 230
<b>- Measuring range 10–20,000 µS/cm (cell constant 0.4 cm<sup>-1</sup>)<sup>a</sup></b>							
316 L SS	35 bar(g) at 25 °C (500 psig at 77 °F)	1" NPTM	316 L SS	28 mm (1.10")	3 m (10 ft)	VP	58 031 264
	17 bar(g) at 200 °C (250 psig at 392 °F)						
<b>- Measuring range 50–40,000 µS/cm (cell constant 10 cm<sup>-1</sup>)<sup>a</sup></b>							
Graphite	17 bar(g) at 93 °C (250 psig at 200 °F)	¾" NPTM	PTFE/SS	86 mm (3.38")	0.5 m (1.5 ft)	S	58 031 241
<b>4-Electrode Sensors<sup>e</sup></b>							
<b>- Measuring range 10–650,000 µS/cm</b>							
316 L SS <sup>d</sup>	5 bar(g) at 150 °C (70 psig at 302 °F)	1.5" Tri-Clamp	PEEK	25 mm (1.00")	-	VP	58 031 242
	14 bar(g) at 50 °C (200 psig at 122 °F)						
316 L SS <sup>d</sup>	5 bar(g) at 150 °C (70 psig at 302 °F)	2" Tri-Clamp	PEEK	25 mm (1.00")	-	VP	58 031 243
	14 bar(g) at 50 °C (200 psig at 122 °F)						
Hastelloy C <sup>d</sup>	5 bar(g) at 150 °C (70 psig at 302 °F)	1.5" Tri-Clamp	PEEK	25 mm (1.00")	-	VP	58 031 245
	14 bar(g) at 50 °C (200 psig at 122 °F)						
316 L SS <sup>d</sup>	5 bar(g) at 150 °C (70 psig at 302 °F)	1.5" Tri-Clamp	PEEK	12 mm (0.50")	-	VP	58 031 248
	14 bar(g) at 50 °C (200 psig at 122 °F)						
Hastelloy C	7 bar(g) at 93 °C (100 psig at 200 °F)	1" NPTM	PEEK	28 mm (1.10")	-	VP	58 031 239
	14 bar(g) at 25 °C (200 psig at 77 °F)						
316 L SS	3.5 bar(g) at 80 °C (50 psig at 176 °F)	1" NPTM	CPVC	28 mm (1.10")	-	VP	58 031 240
	7 bar(g) at 25 °C (100 psig at 77 °F)						
Hastelloy C	3.5 bar(g) at 80 °C (50 psig at 176 °F)	1" NPTM	CPVC	28 mm (1.10")	-	VP	58 031 244
	7 bar(g) at 25 °C (100 psig at 77 °F)						

<sup>a</sup> MΩ × cm = 1/(µS/cm)

<sup>b</sup> See pages 184–185 for retractable housing (also used for pH and ORP)

<sup>c</sup> Tinned leads – no patch cord required

<sup>d</sup> Includes material certification to meet EN 10204 3.1 & USP<88> ClassVI

<sup>e</sup> 4-electrode sensor, maximum patch cord length 15 m (50 ft)

S = Standard connector used with 58 080 25X patch cords only.

See page 231.

VP = VarioPin sealed connector used with 58 080 20X patch cords only (58 080 101 3-ft adapter cable can connect an existing 58 080 25X patch cord to a VP sensor). See page 231.



## Calibration of Conductivity Sensors



### Thornton Auto-loop Factory Calibration System

Thornton conductivity sensors are industry standards for determining water purity and solution concentration. Thornton ISO 9001 factory calibration and certification are NIST and ASTM traceable using Thornton's unique ultrapure auto-loop calibration system. Certification includes test and accuracy, plus materials as noted in sensor specifications.

USP pharmaceutical water monitoring requirements are met with sanitary sensors which provide accurate conductivity and temperature measurement. 316L stainless steel Tri-Clamp mounting sensors have an electropolished finish with roughness average ( $R_a$ )  $<0.2 \mu\text{m}$ ,  $<8 \mu\text{in}$ .

4-electrode sensors are ideal for monitoring high conductivity applications, clean-in-place (CIP) solutions and deionizer regenerant concentrations.



### Did You Know

Thornton conductivity systems are routinely used by other instrument suppliers as the reference to provide traceability when calibrating their instrumentation.



### Conductivity Standard Solutions

Provided for sensor verification and recalibration, conductivity standards are produced, analyzed and documented in the METTLER TOLEDO Thornton ISO 9001 certified facility with processes similar to those used to calibrate high accuracy Thornton conductivity sensors. They are provided with label and certificate with lot number, certified value, expiration date, plus ASTM and NIST traceability data. These standards are analyzed and used at equilibrium with the atmosphere.

### Specifications

Standard	Accuracy	Shelf Life	Order Number
25 $\mu\text{S/cm}$ , 500ml, HCl	$\pm 3\%$	6 months	58 078 001
100 $\mu\text{S/cm}$ , 500ml, KCl	$\pm 1\%$	12 months	58 078 002
1,000 $\mu\text{S/cm}$ , 500ml, KCl	$\pm 1\%$	12 months	58 078 003
10,000 $\mu\text{S/cm}$ , 500ml, KCl	$\pm 1\%$	12 months	58 078 004
100,000 $\mu\text{S/cm}$ , 500ml, KCl	$\pm 1\%$	12 months	58 078 005

### Recommended Conductivity/Resistivity Sensor Service Agreements

Description	Order Number
<b>Calibrate Sensor On-Site</b>	S39905073
<b>Calibrate Custom Certificate</b>	S39905083
Sensor calibrated according to customer tolerances.	
<b>Calibrate Conductivity System</b>	S39905072
Sensor calibrated on customer cable and transmitter.	
<b>Full Preventive Maintenance On-Site</b>	S39905133
Sensor examined, cleaned, and calibrated.	
<b>Setup Standard Configuration</b>	S39905182
Transmitter Configured and function test.	
<b>Calibrate Sensor On-Site</b>	S39905004
<b>Train Initial</b>	S39905211

# pH and ORP Systems

## Reliable in Pure Water Treatment Applications

**With many decades of experience in designing pH/ORP electrodes METTLER TOLEDO offers a state-of-the-art solution for practically any type of process analytical application.**

### Functional definition

pH can be described as a measurement of the relative acidity of a solution. Oxidation reduction potential (ORP) as measured with an ORP electrode, provides an indication of the oxidative state of the solution. It is important to measure, and often to control the pH and/or ORP of a solution for several reasons:

- To produce products with consistent well defined properties
- To efficiently produce products at optimal cost
- To avoid health risks

- To protect the environment
- To prevent physical/chemical damage to materials
- To meet regulatory requirements
- To expand scientific knowledge

The accurate measurement of pH/ORP is critical in most industries. Each application has unique physical requirements of chemical, temperature, and pressure resistance and possibly hygienic design. Another factor is what is to be done with the measurement: monitoring only, data logging or process control.

### pH electrode selection

It is important to understand the details of the application before selecting a pH electrode. The table on the next page gives an initial glance at the various electrodes available and typical applications. Selection of a pH electrode requires a thorough knowledge of the process. Once the requirements are known, comparison of the electrode specifications detailed in this catalog will identify the appropriate sensor.



InPro 3250 i/SG-120



pHure LE



4260 i/SG-120

**Thornton pH electrode selection guide  
by industry and application**

	ORP * Pt 4805 – DPA	Pt 4805 (high pressure) – Dxx pH	4010	3250(i)	4260(i)	4501	pHure Sensor	pHure Sensor LE
<b>Industrial processes</b>								
<b>Pharmaceutical Industry</b>								
Makeup water	•	•		•				
Wastewater				•	•	•		
<b>Power Industry</b>								
Makeup water	•	•		•			•	
Cycle chemistry	•			•			•	•
Stator cooling				•			•	•
Scrubber					•	•		
Wastewater				•	•	•		
<b>Semiconductor Industry</b>								
Makeup water	•	•		•			•	
Recycle, reclaim, waste			•	•	•	•		
<b>Water Treatment</b>								
Air scrubbers		•			•	•		
Cooling water		•	•	•	•	•		
Neutralization	•	•	•	•	•	•		
Potable water			•	•				
<b>Wastewater Treatment</b>								
Flue gas neutralization		•		•	•	•		
Galvanic wastewater	•	•		•	•	•		
Industrial wastewater		•			•	•		
Precipitation of heavy metals		•		•	•	•		
Sludge dewatering		•			•	•		

\* New pH/ORP sensors with ISM allow measurement of pH and ORP with the same sensor!

## pH/ORP Sensors with ISM

### Convenient Maintenance and Calibration



4260i/SG-120 3250i/SG-120

**ISM**

4260i/SG-225  
For Retractable  
Housing

METTLER TOLEDO Thornton offers pH and ORP sensors designed specifically for water treatment. The inclusion of ISM technology allows Plug and Measure capabilities, easier maintenance and convenient calibration. A variety of housings ensure a wide range of installation requirements can be met. The solution ground feature enables ORP measurement and ISM sensor diagnostics, and prevents measurement errors due to ground potentials.

#### Specifications

##### General

Measuring electrode	Glass pH, platinum ORP/solution ground
Reference electrode	Silver-silver chloride with double junction or equivalent
Temperature compensator	NTC included in all sensors
pH range	0 – 14 pH, except InPro 4010 which is 2 – 12 pH
Maximum flow	3 m/s (10 ft/s)
Max. cable lengths	80 m (262.4 ft)

For electrode ratings see table "Ordering Information" on the next page.

For housings see pages 184 – 185.

#### Features Overview

- Convenient electrical and process connections for easy maintenance and calibration
- Advanced METTLER TOLEDO sensor technology for high performance and long life
- Integral temperature sensing for accurate measurement and compensation
- On-line pH sensor diagnostics for assurance of process surveillance

#### Typical Applications

- Wastewater neutralization
- Pharmaceutical water treatment
- Power and steam generation cycle chemistry and scrubbers
- Semiconductor ultrapure water treatment

### Ordering Information

ISM Electrodes	Rating	Sensor Type	Electrode Conn.	Housing Conn.	Length	Order Number
<b>– For pH &amp; ORP, General Purpose, High Pressure Applications ISM</b>						
4260i-SG-120	See housing limits	Glass and Pt	K8S	Pg 13.5	120mm	52 005 381
<b>– For pH &amp; ORP, Retractable ISM</b>						
4260i-SG-225	See housing limits	Glass and Pt	K8S	Pg 13.5	225mm	52 005 382
<b>– For pH &amp; ORP, General Purpose &amp; Moderately Pure Water ISM</b>						
3250i-SG-120	0 to 100 °C (32 to 212 °F)	Glass and Pt	K8S	Pg 13.5	120mm	52 005 373
<b>– For pH, HF-Resistant Applications</b>						
4262i-SG-120	See housing limits	Glass	K8S	Pg 13.5	120mm	30 018 467

Analog Electrodes	Rating	Sensor Type	Electrode Conn.	Housing Conn.	Length	Order Number
<b>– For pH, General Purpose, Applications</b>						
4010-120-Pt1000	0 to 60 °C (32 to 140 °F) 2 bar(g)/60 °C (30 psig/140 °F) 5 bar(g)/45 °C (75 psig/113 °F)	Polysulfone and glass	VP	Pg 13.5	120mm	52 000 512
<b>– For pH, General Purpose, High Pressure Applications</b>						
4260-120-Pt1000	See housing limits	Glass	VP	Pg 13.5	120mm	52 002 987
<b>– For pH &amp; ORP, General Purpose &amp; Moderately Pure Water Applications *</b>						
3250SG-120-Pt1000	0 to 100 °C (32 to 212 °F) 4 bar(g) (60 psig)	Glass	VP	Pg 13.5	120mm	52 002 559
<b>– For pH, HF-Resistant Applications</b>						
4262-120-Pt1000-VP	See housing limits	Glass	VP	Pg 13.5	120mm	52 003 550
<b>– For pH, Retractable Applications</b>						
4260-225-Pt1000	See housing limits	Glass	VP	Pg 13.5 retractable	225mm	52 002 989

Accessories	Order Number
License ISM Core Essential	30 846 306
License ISM Core Advanced	30 846 307
License ISM Core CFR	30 846 348
iLink cable for ISM Core	52 300 383

\* For use with moderately pure waters (conductivity 5 to 50 µS/cm) use 53 300 021 housing in ¾" NPT(M) earth-grounded metal pipe tee with flow < 100 ml/min and discharge to open drain. For higher purity and/or higher accuracy in pure water see pHure Sensor, page 180–183.

\* All new installations require an electrode, housing and cable.

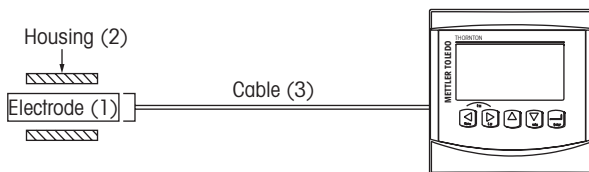

A complete pH or ORP installation requires an electrode (1), a housing (2) and a VP or AS9 cable (3). For suitable housings consult the table on page 184. For suitable cables see table pages 148–149 for analog or page 233 for ISM installations. Each installation requires a transmitter.

For pH/ORP sensors recommended services, see page 183.

## pHure Sensor with ISM

### Reliable pH Measurement in Pure Waters



**ISM**

The METTLER TOLEDO Thornton pHure Sensor™ uses a special internally-pressurized gel electrolyte reference electrode to produce results similar to a flowing junction but with much more convenient installation and maintenance. The electrode also includes a low resistance pH glass membrane, an integral, fast-responding RTD, and AK9 connection. All components of the pHure Sensor have been optimized for performance and value and conform to ASTM Standard D5128. The inclusion of ISM technology allows Plug and Measure capabilities, easier maintenance and convenient calibration. Various lengths of cable can be selected to provide flexibility in locating the sensor.

#### Specifications

Wetted materials	pH Glass
Process connections	¼" NPT(F) in/out
Flow housing volume	5 ml with electrode in place
Maximum pressure	Atmospheric pressure for optimum stability; operational 0 to 2.5 bar(g) (0 to 35 psig); can safely withstand 7 bar(g) (100 psig)
Sample temperature	0 to 80 °C (32 to 176 °F); short term to 100 °C (212 °F)
Sample pH	1 – 11 pH
Sample flowrate	50 to 150 ml/min
Sample conductivity	> 1.5 µS/cm for highest accuracy
Connection	AK9 or VP cable from sensor to instrument

#### Features Overview

- Pressurized gel electrolyte
- Accurate, fast responding temperature compensator
- Low resistance glass membrane
- Low volume 316 stainless steel flow housing

#### Typical Applications

- Reverse osmosis – pH adjustment of clean recycle water or between membranes in two pass systems to optimize rejection rates
- Power plant cycle chemistry
- Monitoring and controlling pH levels to comply with guidelines and minimize corrosion and scaling

### Ordering Information

pHure Sensor		Order Number
pHure Sensor ISM combination electrode with temperature compensator		52 003 821
pHure Sensor combination electrode with RTD		52 002 447
* All new installations require a sensor, housing and cable.		
Housing		Order Number
Flow housing		58 084 010

Cables (pHure Sensor ISM combination electrode with temperature compensator)	
Cable length	AK9
1m (3.3 ft)	59 902 167
3m (9.8 ft)	59 902 193
5m (16.4 ft)	59 902 213
10m (32.8 ft)	59 902 230
20m (65.6 ft)	52 300 204
30m (98.4 ft)	52 300 393
50m (164.0 ft)	52 300 394
80m (262.4 ft)	52 300 395

Cables (pHure Sensor combination electrode with RTD)	
Cable length	VP
1m (3.3 ft)	52 300 107
3m (9.8ft)	52 300 108
5m (16.4 ft)	52 300 109
10m (32.8 ft)	52 300 110

Accessories		Order Number
License ISM Core Essential		30 846 306
License ISM Core Advanced		30 846 307
License ISM Core CFR		30 846 348
iLink cable for ISM Core		52 300 383

\* For pH and ORP buffers, refer to page 185.

pHure Sensor dimensions

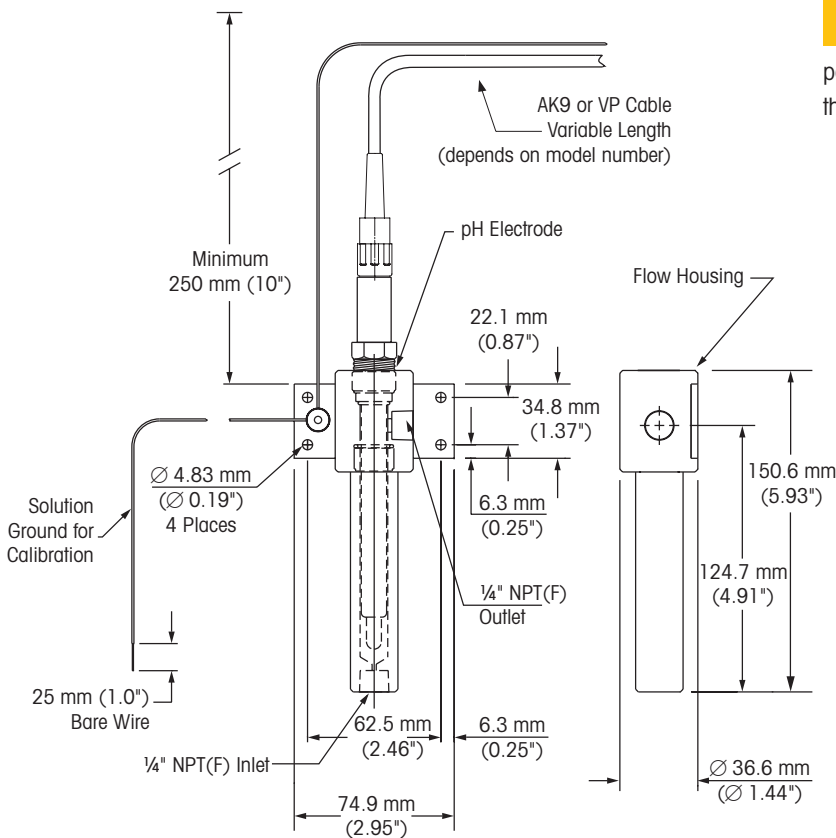

### Did You Know

The small volume and high sample velocity of the pHure Sensor ensures fast response by preventing power plant corrosion products from accumulating around the electrode membrane.

## pHure Sensor LE with ISM

### Reliable pH Measurement in Pure Waters



The METTLER TOLEDO Thornton pHure Sensor LE uses a free-flowing junction to provide the most accurate pH measurement available in low conductivity water. The electrode includes a special pH glass membrane, an integral, fast-responding temperature sensor, and VP or AK9 connection. All components of the pHure Sensor LE have been optimized for performance and value and conform to ASTM Standard D5128. The inclusion of ISM technology allows Plug and Measure capabilities, easier maintenance and convenient calibration. Various lengths of cable can be selected to provide flexibility in locating the sensor.

#### Specifications

Wetted materials	pH Glass, platinum solution ground/ORP
Process connections	1/4" NPT(F) in/out
Flow housing volume	5 ml with electrode in place
Maximum pressure	Atmospheric pressure for measurement; can safely withstand 7 bar(g) (100 psig)
Sample temperature	0 to 100 °C (32 to 212 °F)
Sample pH	1 – 12 pH
Sample flowrate	50 to 150 ml/min
Sample conductivity	> 0.3 µS/cm for highest accuracy
Connection	AK9 or VP cable from sensor to instrument
Reference electrode	3M KCl

#### Features Overview

- Free-flowing junction / diaphragm
- Simultaneous pH & ORP measurements
- Accurate, fast responding temperature compensator
- Low resistance glass membrane
- Low volume 316 stainless steel flow housing
- Easily refillable electrolyte chamber

#### Typical Applications

- Power plant cycle chemistry where pH measurement in low conductivity water is critical
- Reverse osmosis – pH adjustment of clean recycle water or between membranes in two pass systems to optimize rejection rates
- Monitoring and controlling pH levels to comply with guidelines and minimize corrosion and scaling

**ISM**



## Ordering Information

pHure Sensor LE		Order Number
pHure Sensor LE ISM electrode		30 039 086
pHure Sensor LE analog electrode		30 039 085
* All new installations require a sensor, housings and cable.		
* For pH and ORP buffers, refer to page 185.		
Consumables		Order Number
Replacement electrolyte 3M KCl 250 ml		51 340 049
Replacement syringe for electrolyte refill		58 079 520
Housing		Order Number
SS flow housing		58 084 017

Cables (pHure Sensor LE ISM combination electrode with temperature compensator)	
Cable length	AK9
1m (3.3 ft)	59 902 167
3m (9.8 ft)	59 902 193
5m (16.4 ft)	59 902 213
10m (32.8 ft)	59 902 230
20m (65.6 ft)	52 300 204
30m (98.4 ft)	52 300 393
50m (164.0 ft)	52 300 394
80m (262.4 ft)	52 300 395

Cables (pHure Sensor LE combination electrode with RTD)	
Cable length	VP
1m (3.3 ft)	52 300 107
3m (9.8 ft)	52 300 108
5m (16.4 ft)	52 300 109
10m (32.8 ft)	52 300 110

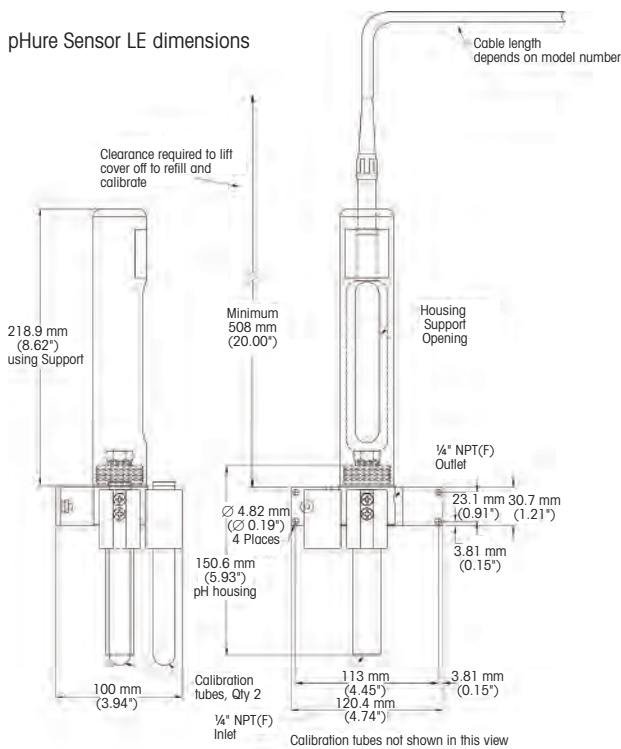

## Recommended pH Sensor Service Agreements

Description	Order Number
<b>Setup Standard Configuration</b>	S39905182
Provides fast and reliable setup and standard configuration to ensure the sensor is ready for use in customer's application.	
<b>Standard Care</b>	B39910002
Maximize uptime with this full coverage over the first 12 months of your equipment's life. Preventive maintenance services include: visual inspection, sensor cleaning, preventive maintenance (consumables replacement and calibration).	

## pH/ORP Housings

### Flexibility in Meeting Process Requirements



58 084 002



53 300 021



58 084 014

METTLER TOLEDO Thornton housings provide a fixed NPT or solvent weld process connection. For easy access to the electrode for cleaning, calibration or replacement, they have internal O-ring seals with hand-tightened mounting nut. The compact METTLER TOLEDO electrode design includes measuring, reference and fast-responding temperature compensator functions so only a single process connection is ever needed.

Housings should be mounted to orient the tip of the electrode at least 15° below horizontal to ensure reliable contact of internal electrolyte with the measuring membrane. They should not be mounted horizontally or upside-down.

#### Specifications

pH Housings	Order Number		
	53 300 021	52 401 520	58 084 014
Wetted parts	CPVC	PVDF	PVC
Sensor fitting	¾" NPT(M) insertion or submersion <sup>a</sup>	¾" NPT(M) insertion or submersion <sup>a</sup>	1" weld tee
Pressure rating	7 bar(g) at 20 °C (100 psig at 68 °F) 2 bar(g) at 80 °C (30 psig at 176 °F)	6 bar(g) at 20 °C (87 psig at 68 °F) 1 bar(g) at 100 °C (15 psig at 212 °F)	3.5 bar(g) at 60 °C (50 psig at 140 °F)

Suitable pH sensors

(by Order Number)<sup>b</sup>:

- 52 005 381	•	•	•
- 52 005 373	•	•	•
- 52 000 512	•	•	•
- 52 002 987	•	•	•
- 52 002 559	•	•	•
- 30 018 467	•	•	•
- 52 003 550	•	•	•

pH Housings	Order Number
	58 084 002
Wetted parts	CPVC
Sensor fitting	Retractable 1½" NPT(M)
Pressure rating	5 bar(g) at 80 °C (75 psig at 176 °F)

Suitable pH sensors

(by Order Number)<sup>b</sup>:

- 52 005 382	•
- 52 002 989	•

<sup>a</sup> For insertion in plastic pipe, use ¾ × 1" reducing bushing and 1" pipe tee.

For submersion with plastic pipe, use ¾ × 1" reducing coupling and 1" pipe.

<sup>b</sup> For information about the corresponding pH sensors consult page 179.

### Drawings of pH housings

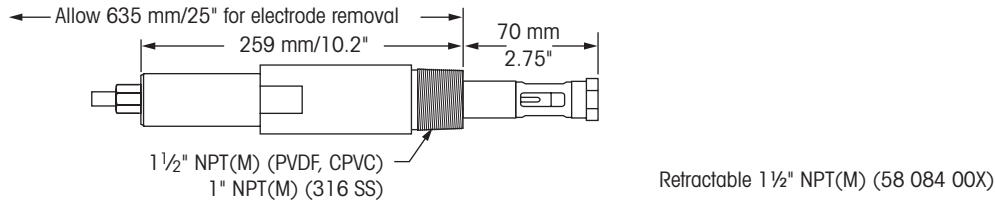
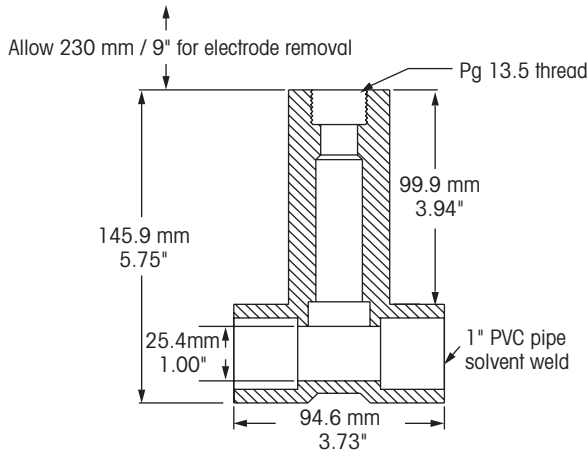
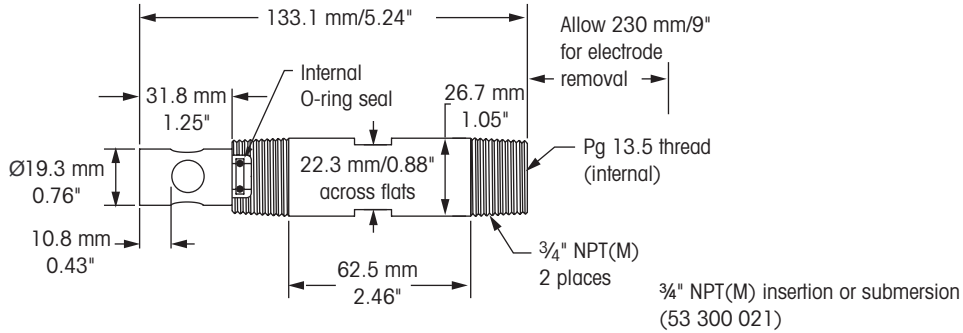

### pH and ORP (Redox) Standard Buffer Solutions



#### Ordering Information

pH and Redox Buffers	Volume	Order Number
<b>pH Buffers</b>		
pH 4.01 buffer	250 ml	51 340 057
pH 7.00 buffer	250 ml	51 340 059
pH 9.21 buffer	250 ml	51 300 193
pH 10.00 buffer	250 ml	51 340 056
<b>Redox Buffers</b>		
Redox buffer 220 mV	6 × 250 ml	51 340 081

# Oxygen Measurement Systems

## High Reliability and Wide Application Coverage

**METTLER TOLEDO provides sensors to measure dissolved oxygen (DO) in demanding low ppb-level applications.**

### Measurement of dissolved oxygen

Proper oxygen levels are important in many processes involving the use of pure and ultrapure water. Control of dissolved oxygen will minimize corrosion, reduce costs or provide maximum semiconductor product yield.

### The optical dissolved oxygen sensor

with its durable OptoCap sensing element ensures fast response time, highly accurate measurement, very low maintenance, and no dissolved hydrogen interference.

### Electrochemical oxygen sensors

The Thornton high-performance sensors have been designed for in-line measurements of dissolved oxygen in the low ppb-range in power plant cycle chemistry and in ultrapure water applications of the semiconductor industry.

### Professional service and validation

Sensor service includes rebuilding, cleaning, testing, and recertification of your Thornton sensor, done quickly and efficiently to minimize downtime.



Optical DO Sensor



High Performance DO Sensor

# Ozone Measurement Systems

## Provide Accurate Response and Excellent Sensitivity

**METTLER TOLEDO Thornton's dissolved ozone measurement systems show rapid and accurate response to ozone concentrations. The excellent sensitivity gives positive detection of zero ozone after destruction by UV light.**

### Measuring principles

Ozone passes through a gas-permeable reinforced membrane of exceptional durability producing an electrochemical reaction and current flow in direct proportion. Behind the membrane is the platinum cathode where ozone reacts to produce the measurement signal. The electrochemical reaction is completed at the silver anode. Full temperature compensation accounts for effects of both membrane permeability and solubility of ozone in water.

### Important features

- Rapid, accurate response
- Positive zero detection
- Low maintenance with drop-in modular membrane

### Ozone sanitization of pharmaceutical water systems

Complete sanitization is achieved by controlling ozonation downstream of the storage tank. A second ozone measurement guarantees the removal of all ozone downstream of UV destruction.

### Ozone sanitization of semiconductor ultrapure water

Ozone sanitization can be controlled by monitoring the ozone concentration downstream of the ozonator and UPW storage tank. To be sure all ozone has been decomposed after UV lights, a second ozone measurement can confirm a zero level.

### Ozone sanitization of bottled water

Continuous measurement and control to proper ozone levels of bottled water is a required quality practice that promotes consistent good taste and long shelf life.

### Ozone sanitization of beverage systems

Ozonated water is used in place of chemicals for CIP operations when changing between flavors. Ozone provides cleaning and disinfection without risk of objectionable residuals or byproducts.



pureO<sub>3</sub> Dissolved Ozone Sensor

## Pure Water Optical DO Sensor

### Fast Response, Reduced Maintenance



METTLER TOLEDO Thornton's Optical DO Sensor provides high accuracy, fast response and increased stability in demanding low ppb-level applications. The outstanding measurement performance with low detection limit, minimum drift and shorter response time improves oxygen monitoring. The proprietary OptoCap design allows highly accurate measurement of dissolved oxygen without susceptibility to hydrogen interference in power generation. The easy maintenance without liquid handling and polarization increases the availability of the measuring system. Easy maintenance, without liquid handling and sensor polarization increases the convenience of the measuring system. Predictive maintenance with ISM permits easy maintenance planning, reducing downtime.

#### Specifications

Operating range	0 – 5000 ppb
System accuracy	± 2 % of reading or 2 ppb, whichever is greater
Response time at 25 °C (77°F) (Air_N <sub>2</sub> )	98 % of final value in < 20 s
Sampling rate	Adjustable between 1 and 60 seconds
Sample flow rate	50 – 800 ml/min
Temperature compensation	Automatic
Measuring temperature range	0 – 50 °C (50 – 122 °F) for DO measure
Environmental temperature range	0 to 121 °C (32 to 250 °F)
Operating pressure	0.2 to 12 bar (2.9 to 174 psi absolute)
Design pressure	Maximum 12 bar (174 psi absolute)
Sample connections	¼" NPT(F)
Wetted materials	Stainless steel, silicone, EPDM O-ring
Cable length	2 – 50 m (6.6 – 164.0 ft)
Components needed	Optical DO probe, housing and cable

#### Construction

Measuring principle	Fluorescence quenching
Cable connection	5-pin
Connector design	Straight
Sensor body	316L stainless steel
Membrane material	Silicone
O-ring material	EPDM (FDA-positive listed)
Sensor diameter	12 mm

#### Features Overview

- High accuracy
- Fast response
- Enhanced stability and reliability
- Reduced maintenance and downtime
- No dissolved hydrogen interference
- No flow sensitivity

#### Typical Applications

- Power plant cycle chemistry monitoring
- Generator stator cooling
- Semiconductor ultrapure water
- Pure water treatment systems

## Ordering Information

Optical DO Sensor	Order Number
Pure Water ISM Optical DO Probe	30 041 040
* All new installations require a sensor, housing and cable.	
Required Accessories	
Pure Water 316 Stainless Steel Housing	58 084 018
Sensor Cables	
2 m (6.6 ft)	52 300 379
5 m (16.4 ft)	52 300 380
10 m (32.8 ft)	52 300 381
15 m (49.2 ft)	52 206 422
25 m (82.0 ft)	52 206 529
50 m (164.0 ft)	52 206 530
Spare Parts	
OptoCap Replacement Kit	52 206 403
Accessories	Order Number
License ISM Core Essential	30 846 306
License ISM Core Advanced	30 846 307
License ISM Core CFR	30 846 348
iLink cable for ISM Core	52 300 399

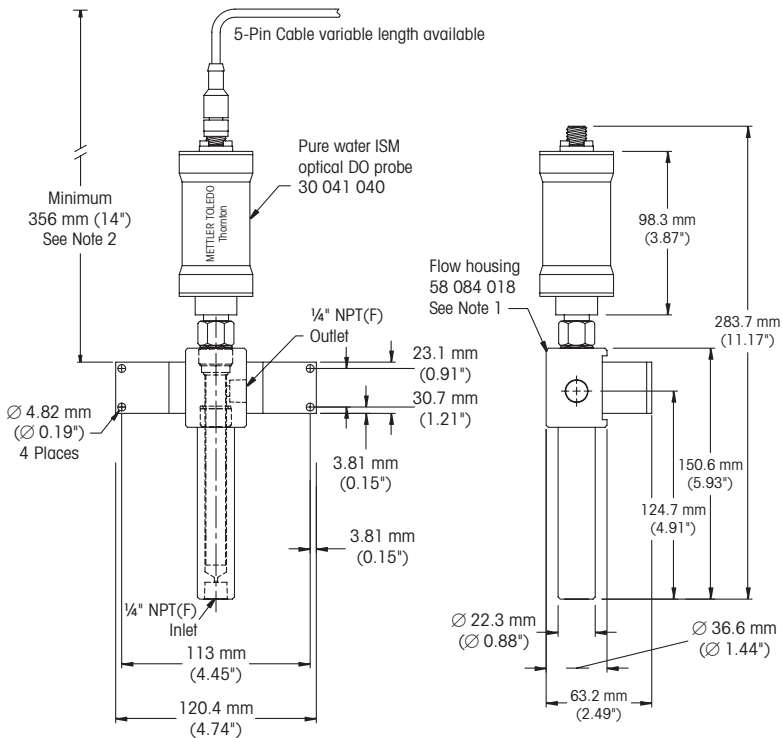

### Notes:

1. Electrode/Flow housing assembly must be in upright position as shown.
2. Allow at least 356 mm (14") clearance to remove sensor.

## Recommended Optical DO Sensor Service Agreements

Description	Order Number
<b>Setup Standard Configuration</b> Provides fast and reliable setup and standard configuration to ensure the sensor is ready for use in customer's application.	S39905182
<b>Extended Care</b> Maximize uptime with this full coverage over the first 24 months of your equipment's life. Preventive maintenance services include: visual inspection, preventive maintenance (OptoCap replacement and calibration).	B39950001
<b>Standard Care</b> Maximize uptime with this full coverage over the first 12 months of your equipment's life. Preventive maintenance services include: visual inspection, preventive maintenance (OptoCap replacement and calibration).	B39910002

# High Performance Dissolved Oxygen Sensors with ISM

## Fast, Accurate Response



**ISM**

METTLER TOLEDO Thornton's high performance ppb-level dissolved oxygen measurement capability excels in demanding low ppb-level applications. It provides a precise zero and a highly accurate response over the entire range of measurement. This allows it to perform well at any level as well as providing very fast response to changes from one level to another. The inclusion of ISM technology allows Plug and Measure capabilities, easier maintenance and convenient calibration.

### Specifications

Sample flow rate	50 to 1,000 ml/min
Sample temperature	0 to 60 °C (32 to 140 °F) for temperature compensation; can tolerate 100 °C (212 °F)
Sample pressure	0 to 5 bar(g) (0 to 72 psig)
Sample connections	1/4" NPT(M)
Wetted materials	Polyacetal flow housing, polyphenylene sulfide probe body, PTFE membrane reinforced with stainless steel and silicone rubber, Viton® and silicone rubber O-rings
Cable length	Probe to instrument: 1 to 80 m (3.3 to 262.4 ft)
Weight	1 kg (2 lb) with flow housing
Response time	98 % of final value in 90 s
Operating range	0–10,000 ppb (µg/L)
System accuracy	± 1 % of reading or 1 ppb, whichever is greater; ± 0.5 °C

### Features Overview

- High accuracy
- Simple maintenance with drop-in modular membrane
- Excellent long-term stability
- Temperature compensation for membrane permeability and oxygen solubility effects

### Typical Applications

- Power plant cycle chemistry monitoring
- Semiconductor ultrapure water
- Pure water treatment systems



**Ordering Information**

High Performance Dissolved Oxygen Sensor	Order Number
ISM High Performance DO probe	52 201 209
Analog High Performance DO probe	52 201 067
Spare parts and Accessories for All High Performance Sensors	
Maintenance kit (electrolyte and 4 membranes)	52 200 024
Analog Polarization module (for portable use with VP cable)	52 200 893
DO electrolyte pack (3 × 25 ml)	30 298 424
Single membrane body	52 200 071
Flow housing	58 084 009

\* All new installations require a sensor, housing, cable and electrolyte.

Cables (High Performance Dissolved Oxygen probe ISM)	
Cable length	AK9
1m (3.3 ft)	59 902 167
3m (9.8 ft)	59 902 193
5m (16.4 ft)	59 902 213
10m (32.8 ft)	59 902 230
20m (65.6 ft)	52 300 204
30m (98.4 ft)	52 300 393
50m (164.0 ft)	52 300 394
80m (262.4 ft)	52 300 395

Cables (High Performance Dissolved Oxygen probe analog)	
Cable length	VP
1m (3.3 ft)	52 300 107
3m (9.8 ft)	52 300 108
5m (16.4 ft)	52 300 109
10m (32.8 ft)	52 300 110

Accessories	
License ISM Core Essential	30 846 306
License ISM Core Advanced	30 846 307
License ISM Core CFR	30 846 348
iLink cable for ISM Core	52 300 383

Dimensions of the ISM High Performance Dissolved Oxygen Sensor

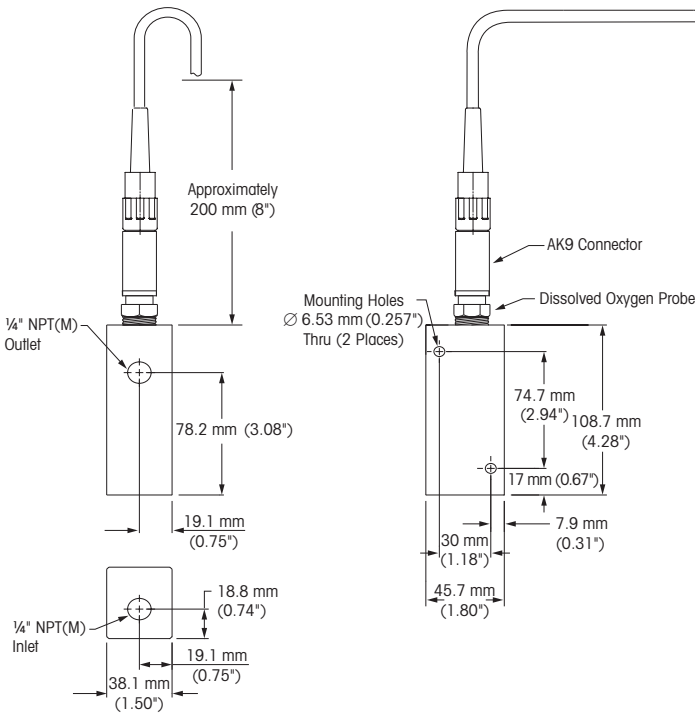

**Did You Know**  
The fast response of high performance DO sensors allows real-time tracking of start-up deaeration.

**Recommended Dissolved Oxygen Sensor Service Agreements**

Description	Order Number
<b>Setup Standard Configuration</b> Provides fast and reliable setup and standard configuration to ensure the sensor is ready for use in customer's application.	S39905182
<b>Extended Care</b> Maximize uptime with this full coverage over the first 24 months of your equipment's life. Preventive maintenance services include: visual inspection, preventive maintenance (electrolyte replacement, membrane body replacement, inner body replacement, and calibration).	B39950001
<b>Standard Care</b> Maximize uptime with this full coverage over the first 12 months of your equipment's life. Preventive maintenance services include: visual inspection, preventive maintenance (electrolyte replacement, membrane body replacement, inner body replacement, and calibration).	B39910002

## pureO<sub>3</sub> Dissolved Ozone Sensor with ISM For Reliable Process Control



**ISM**

The pureO<sub>3</sub><sup>™</sup> dissolved ozone sensor uses proven technology along with ISM for rapid and accurate response to a wide range of ozone concentrations. pureO<sub>3</sub> provides reliable ozone measurement in conjunction with many transmitters including various M800, M400, M300 and M200 ISM models. Intelligent sensor data is stored in memory, providing Plug and Measure simplicity with enhanced diagnostics capabilities. Robust sensor construction is coupled with a membrane cartridge which allows exceptionally fast and easy replacement of electrolyte and membrane when necessary.

### Specifications

Sample flow rate	200 to 500 ml/min with housing; 0.15 to 1 m/s (0.5 to 3 ft/s) without housing
Sample temperature	5 to 50 °C (41 to 122 °F) for compensation; probe can withstand 100 °C (212 °F)
Sample pressure	Normal operation, atmospheric; can withstand 0.8 to 3 bar absolute (0 to 45 psig)
Sample connections	1/4" NPT(F)
Wetted materials	Polycarbonate or 316 stainless steel flow housing, 316L/1.4404 stainless steel probe, silicone rubber membrane, FKM O-rings
Cable lengths	1 to 80 m (3.3 to 262.4 ft)
Weight	0.5 lb (227 g)
Response time	90% response in 30 s
Operating range	0–5,000 ppb (mg/L); 0–5.0 ppm (mg/L) short term; 0–500 ppb (mg/L); 0–0.5 ppm (mg/L) continuous
System accuracy	± 1% of reading or 0.4 ppb, whichever is greater

### Features Overview

- Reinforced silicone membrane for exceptional durability
- Full temperature compensation accounts for effects of both membrane permeability and solubility of ozone in water
- Membrane cartridge provides easy replacement of electrolyte and membrane
- 21CFR Part 11 Data Integrity option when paired with an M800 Transmitter and RecordLOC software (see page 235)

### Applications

- **Pharmaceutical water systems**  
Monitors sanitization levels and ensures removal of all ozone to satisfy the “no added substance” requirement, plus data integrity.
- **Semiconductor ultrapure water systems**  
Monitors ozone concentration downstream of the ozonator and UPW storage tank

### – Bottled water systems

Continuous ozone measurement is a key quality practice to provide good, consistent taste and long product shelf life

### – Beverage systems

Ozone replaces caustic chemicals for clean-in-place operations, providing disinfection without objectionable byproducts

▶ [www.mt.com/Thornton-Ozone](http://www.mt.com/Thornton-Ozone)

## Ordering Information

Ozone Sensor	Order Number
pureO <sub>3</sub> Dissolved Ozone sensor	30 139 305
<b>Required Accessories</b>	
Polycarbonate Housing	58 084 012
Stainless Steel Housing	58 084 020
<b>Spare Parts</b>	
pureO <sub>3</sub> membrane kit including electrolyte, 4 membranes and O-rings	30 235 170
Interior sensor body for pureO <sub>3</sub>	30 236 790
pureO <sub>3</sub> electrolyte, 25 ml	30 135 837
<b>ISM Sensor Cables</b>	
1.0m (3.3 ft)	59 902 167
3.0m (9.8 ft)	59 902 193
5.0m (16.4 ft)	59 902 213
10.0m (32.8 ft)	59 902 230
20m (65.6 ft)	52 300 204
30m (98.4 ft)	52 300 393
50m (164.0 ft)	52 300 394
80m (262.4 ft)	52 300 395

\* All new installations require a sensor, housing and cable.

## Dimensions

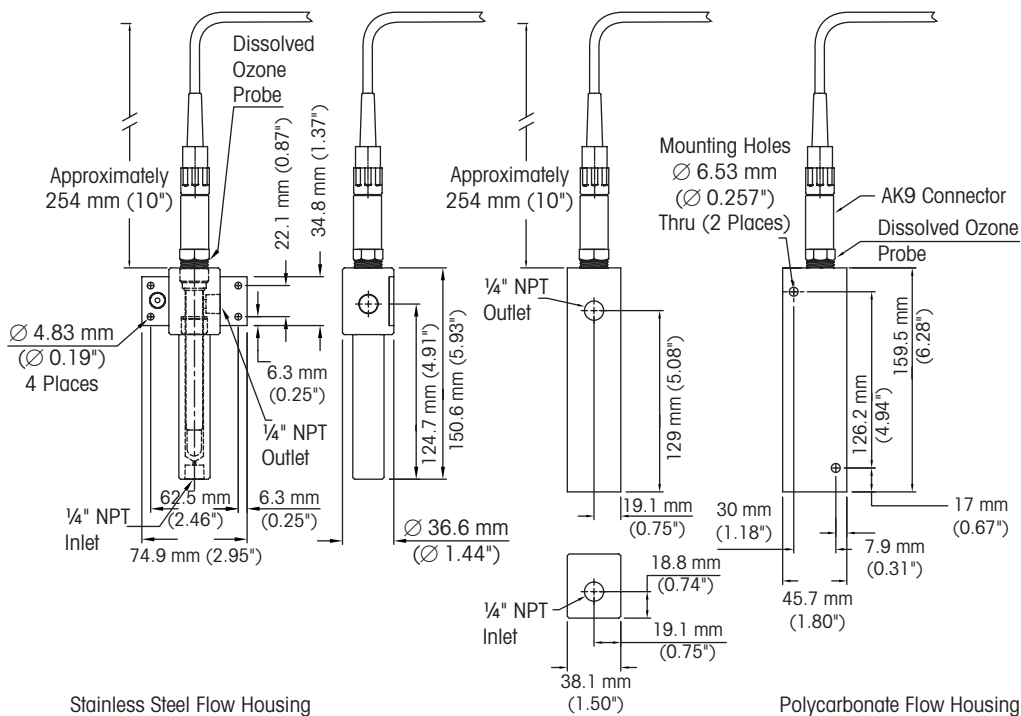

## Notes:

- Sensor/flow housing assembly must be in upright position as shown.
- Allow approximately 254 mm (10") clearance to remove sensor.

## Recommended Dissolved Ozone Sensor Service Agreements

Description	Order Number
<b>Setup Standard Configuration</b> Provides fast and reliable setup and standard configuration to ensure the sensor is ready for use in customer's application.	S39905182
<b>Extended Care</b> Maximize uptime with this full coverage over the first 24 months of your equipment's life. Preventive maintenance services include: visual inspection, preventive maintenance (electrolyte replacement, membrane body replacement, inner body replacement, and calibration).	B39950001
<b>Standard Care</b> Maximize uptime with this full coverage over the first 12 months of your equipment's life. Preventive maintenance services include: visual inspection, preventive maintenance (electrolyte replacement, membrane body replacement, inner body replacement, and calibration).	B39910002

# Vortex Flowmeters

## Maintenance Free, All-Plastic Construction



The ultimate solution for measuring the flow rates of ultrapure water and chemicals. The vortex flow sensors consist of a molded unibody and are available in PFA, PVC or PVDF. With no moving parts, any potential for fluid contamination is eliminated by the corrosive-resistant, all-plastic construction.

**Specifications**

<b>PFA Version</b>	
Display	4-digit LED plus high & low alarm indicators
Connections	Straight tube ends or Flaretek
Straight tube requirements	10 x diameter upstream and 2 x diameter downstream
Wetted materials	PFA Perfluoroalkoxy
Temperature	0 – 100 °C (32 – 212°F)
Viscosity	For liquids more viscous than water, consult Thornton
Electrical connections	2 m (6.5 ft) cable may be extended with 22 gauge 6-conductor shielded cable up to 100 m (325 ft) for pulse input only
Enclosure	NEMA 4X, IP65
Power supply	One external 12 - 24 VDC isolated power supply is required for one or two pulse input sensor
Certificate	CE rated, certificate of accuracy included

**Ordering Information Flow Vortex**

<b>PFA Versions</b>					
Size	Flow Rate l/min (g/m)	Maximum Pressure		Order Number	
		at 20 °C (68°F)	at 100 °C (212°F)		
<b>Straight Tube-end – Connections</b>					
½"	2 – 20 (0.5 – 5)	10 bar(g) (145 psig)	7 bar(g) (100 psig)	58 034 401	
¾"	10 – 70 (2.7 – 19)	7 bar(g) (100 psig)	4 bar(g) (58 psig)	58 034 402	
1"	15 – 150 (4 – 40)	5 bar(g) (70 psig)	3 bar(g) (43 psig)	58 034 403	

**Flow Transmitter Options\***

Model	Mounting	Flow Channels	Order Number
M200, Flow 1-channel	¼-DIN Panel	1	30 280 748
M200, Flow 4-channel	¼-DIN Panel	4	30 280 749
M800, Waer 2-channel	½-DIN	2	58 000 802
M800, DP Water 2-channel	½-DIN	2	58 000 806
M800, Water 4-channel	½-DIN	4	58 000 804

\*One external 12VDC isolated power supply is required for one or two PFA Vortex pulse input sensor(s)

## Technical Data Vortex Sensors PFA Versions

### Flowrate Range for PFA Vortex Flowmeters

Size	Minimum Flowrate									Max Flowrate (l/min)
	(l/min)									
cp*	0.3	0.5	0.7	1**	2	3	4	5	7	—
1/2"	0.6	1	1.4	2	4	6	8	10	14	20
3/4"	3	5	8	10	20	30	40	50	70	70
1"	4.5	7.5	10.5	15	30	45	60	75	105	150

\* cp = Viscosity of measurement fluid (in centipoises)

\*\* Viscosity of water at 20 °C

### Straight Tube-End Dimensions (mm)

Size	+0.30		t ± 0.5	L
	D -0.10	d -0.10		
1/2"	∅ 12.7	∅ 9.52	1.59	190
3/4"	∅ 19.05	∅ 15.88	1.59	190
1"	∅ 25.4	∅ 22.22	1.59	190

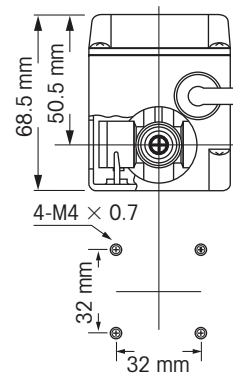
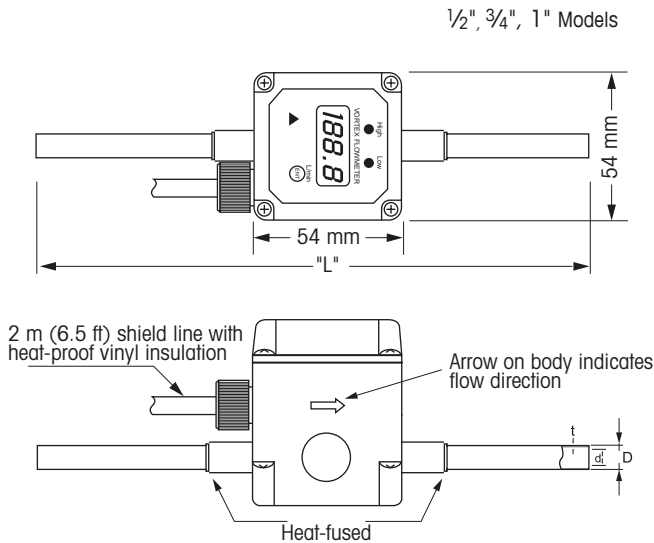

Mounting Dimensions  
(for all models)

## Sanitary Flow Sensors High Quality, Precision



The sanitary turbine flow sensors are designed and manufactured to be compliant with the ASME Bioprocessing Equipment Standard BPE-2014 for measurement of process liquids where high sanitary standards are required. ASME-BPE-2014 is the leading standard on how to design and build equipment used in the production of biopharmaceuticals. This series includes 11 sizes, ¼" to 3" with standard Tri-Clamp™ fittings, covering flow rates of 0.75 to 400 GPM.

### Specifications

Wetted Parts	Body 316 SS, Ra 32 microinch (0.8 micrometer) finish; 17- 4PH SS rotor; PH 15 – 7 Mo SS retaining rings; hard carbon composite bearings.
Certification	3A Rated, manufacturers calibration and materials certificates included.
Electrical connections	Wiring may be run up to 610 m (2,000 ft) with 3 conductor, 20 gauge, shielded cable, such as Belden 9364.
Process connections	To achieve optimum performance, maintain 3A certification and to protect the bearings from excess turbulence and damage, a minimum of 10 pipe diameters upstream and 5 pipe diameters downstream of turbine size pipe must be used.
Linearity	± 0.5 % of reading*
Repeatability	± 0.1 % of reading*
Temperature Range	-40 °F to +325 °F, process fluid with std. magnetic pickup coil

\* Based on manufacturer's calibration in water at 70 °C

Flow Range LPM (GPM)	Tri- Clamp Fitting (C)	Turbine Size	Length (A) mm/inch	Pulse Input Order Number
2.8 – 28 (0.75 – 7.5)	3/4"	3/8"	90.4/3.56	58 034 655
6.6 – 60 (1.75 – 16)	1 – 1/2"	5/8"	90.4/3.56	58 034 656
9.5 – 110 (2.5 – 29)	1 – 1/2"	3/4"	82.6/3.25	58 034 657
15 – 227 (4 – 60)	1 – 1/2"	1"	90.4/3.56	58 034 658
30 – 492 (8 – 130)	1 – 1/2"	1 – 1/2"	116.6/4.59	58 034 659
57 – 852 (15 – 225)	2"	2"	153.9/6.06	58 034 660
95 – 1,514 (25 – 400)	3"	2 – 1/2"	254/10.00	58 034 661

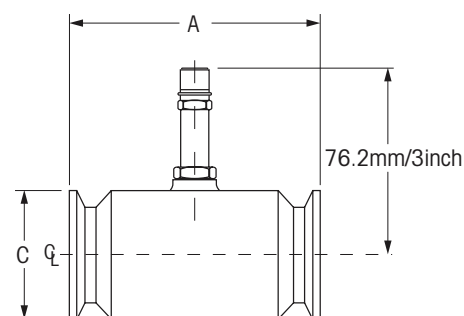

### Flow Transmitter Options

Model	Mounting	Flow Channels	Order Number
M200, Flow 1-channel	1/4-DIN Panel	1	30 280 748
M200, Flow 4-channel	1/4-DIN Panel	4	30 280 749
M800*, Water 2-channel	1/2-DIN	2	58 000 802
M800*, DP Water 2-channel	1/2-DIN	2	58 000 806
M800*, Water 4-channel	1/2-DIN	2	58 000 804

\*The M800 Pulse Flow Adapter (part number 58 080 116) allows an M800 ISM channel to be used with a pulse flow sensor to expand the number of flow sensors per M800 transmitter. The pulse output of the flow sensor is converted to a digital signal at the adapter and transmitted to the M800's ISM channel. By using the adapters, you can now connect up to four pulse flow sensors to a 2-channel M800 (2 ISM channels + 2 pulse channels) or six flow sensors to a 4-channel M800 (4 ISM channels + 2 pulse channels).

See p. 225 for full flow capabilities.

## Total Organic Carbon (TOC) ISM Technology

### Introduction to ISM Technology

The 6000TOC*i* Sensor uses Intelligent Sensor Management technology interfacing with the M800 Multi-parameter Transmitter. This technology allows the M800 to recognize the configuration and sensor parameters when connected. The M800 transmitter will allow up to two or four 6000TOC*i* Sensors to be connected to any of the four input channels. Any remaining channels are available for use with any other ISM Sensors. The M800 also provides two pulse input channels for additional flow measurements.

The sensor connects directly to the M800 transmitter using standard patch cables. The 6000TOC*i* Sensor is designed to meet the requirements of today's industrial facilities with its CE and UL ratings. Combined with the M800 transmitter it provides the most versatile and flexible TOC measurement platform available.

### Measurement Technology UV Oxidation/Differential Conductivity

Thornton 6000TOC*i*, 4000TOC*e* and 450TOC products use proven ultraviolet oxidation with differential conductivity (see Figure 1) as the method to effectively determine TOC concentrations.



High performance digital conductivity sensors provide continuous conductivity measurement before and after sample oxidation. This is accomplished using a continuous flow-through spiral quartz tube design that allows the sample to flow continuously through the sensor. This design maximizes exposure to the 185 nanometer UV light, while minimizing measurement response time and providing complete oxidation. This simple and effective design requires no reagents or chemicals and has no moving mechanical components.

The formation of hydroxyl radicals in the water during UV exposure produces a mechanism through which bonds in non-ionic organic compounds are broken and oxidation occurs to form products such as carbon dioxide and water. The carbon dioxide dissolves

in the water and forms carbonic acid, which dissociates into ionic-conductive species. This change in conductivity is associated with TOC (see Figure 2).

### USP/EP and SST

In the Pharmaceutical Water production process, System Suitability Testing (SST) is an essential activity to verify the performance of a Total Organic Carbon monitoring system and to ensure its adequacy for TOC analysis.

### USP and EP Requirements

In the requirements for TOC measurement, the United States Pharmacopoeia and European Pharmacopoeia have established specific Total Organic Carbon (TOC) tests as described in USP General Chapter <643> and EP Chapter 2.2.44, respectively.



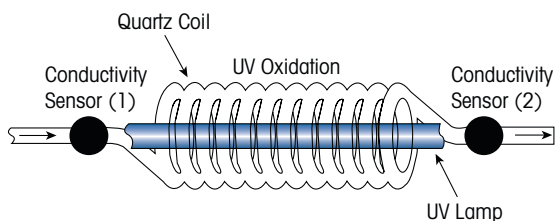

Figure 1

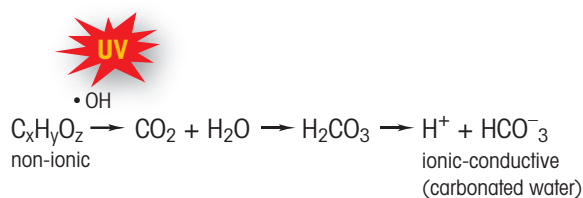

Figure 2

### A TOC sensor model to meet your exact needs



#### 6000TOCi

The 6000TOCi on-line sensor delivers true continuous measurement for the detection of organic contamination. With an extremely rapid response to TOC changes, the 6000TOCi is ideal for all pure water applications where real-time monitoring is critical.



#### 6000TOCi Low PPB

The 6000TOCi low ppb on-line sensor delivers rapid response and trace sensitivity to organics at sub-ppb concentrations to meet the semiconductor application demand of achieving ever-narrowing line widths. The sensor's real-time response reveals swift changes in TOC levels, ensuring greater process control over UPW purification.



#### 4000TOCe

The on-line 4000TOCe total organic carbon sensor provides real-time monitoring of TOC levels for pure and ultrapure water applications, from reverse osmosis post-treatment to point-of-use. The 4000TOCe sensor, combined with the menu-driven M300 transmitter, provides an easy-to-use analytical package that enhances operational performance and offers extensive system diagnostics.



#### 450TOC Portable

The 450TOC total organic carbon analyzer offers the fastest response available in an easily transportable TOC system. Its robust, portable design and convenient multi-point sampling ability make the 450TOC a valuable tool for periodic sampling and water system diagnostics.

# Total Organic Carbon

A TOC Sensor with Reliable Performance

Total Organic Carbon

## 4000TOCe

### Easy to Use On-line Measurement



The enhanced 4000TOCe Sensor provides continuous on-line measurement of Total Organic Carbon in a low maintenance industrial package. In addition to using proven UV oxidation with differential conductivity to determine TOC concentration, the 4000TOCe model also features automatic flow control to ensure consistent water flow through the system.

#### Features/Benefits

- On-line continuous measurement for fastest response
- Advanced UV lamp design extends stability and wavelength emission over lamp life
- Sample Conditioning Coil (included) can prevent CO<sub>2</sub> permeation into the water sample and will stabilize inlet flow, pressure and temperature irregularities
- Local LED Sensor status indication
- Continuous flow design provides rapid detection of system changes
- No gases or reagents to handle, store or replace and no moving parts minimize routine maintenance and service intervals
- Plug and measure sensor design reduces installation and setup time
- Real-time continuous monitoring for precise data trending and better process control
- Wide dynamic operating range meets the needs of pure and ultrapure water applications
- Meets USP <643>, <645>, EP 2.2.44, Ch.P and JP requirements for the Pharmaceutical Industry



#### Applications

- Pure and Ultrapure water
- Pharmaceutical-grade water
- Recycle and reclaim
- Power generation

#### 4000TOCe Sensor Ordering Information

Description	Order Number
4000TOCe Sensor, 110VAC, 50/60 Hz	30 415 866
4000TOCe Sensor, 220VAC, 50/60 Hz	30 415 867
<b>Accessories</b>	
Kit, Tool, TOC Sensor	58 091 520
Kit, Pipe mounting, for 1-1/2" nominal pipe size	58 091 521
High Pressure Inlet Regulator, 1/4" NPT-female	58 091 552
Outlet Drain Tube	58 091 553
<b>Consumables and Spare Parts</b>	
Replacement Inlet Filter Element, 60 micron (Pkg.2) (Recommended with lamp change)	58 091 551
Replacement UV Lamp (recommended every 4,500 hours of operation)	58 079 513
Kit, Fuse, Sensor PCB (for use on both 110 and 220 VAC models)	58 091 519
System Suitability Standards (For use with Cal/SST KIT 58 091 566)	58 091 526
Calibration Standards (For use with Cal/SST KIT 58 091 566)	58 091 529
Combined Calibration and SST Standards (For use with Cal/SST KIT 58 091 566; contains 58 091 526 and 58 091 529)	58 091 537

#### For use with M300TOC Transmitters

Description	Order Number
M300TOC ¼ DIN Enclosure (Panel mounting kit included)	30 414 214
M300TOC ½ DIN Enclosure	30 414 212

▶ [www.mt.com/4000TOCe](http://www.mt.com/4000TOCe)

## Specifications

### 4000TOCe Sensor

Measurement range	0.05 – 1000 ppbC (µgC/L)
Accuracy	± 0.1 ppb C for TOC < 2.0 ppb (for water quality > 15 MΩ-cm [0.067 µS/cm]) ± 0.2 ppb C for TOC > 2.0 ppb and < 10.0 ppb (for water quality > 15 MΩ-cm [0.067 µS/cm]) ± 5% of measurement for TOC > 10.0 ppb (for water quality 0.5 to 18.2 MΩ-cm [2.0 to 0.055 µS/cm])
Repeatability	± 0.05 ppb C < 5 ppb, ± 1.0 % > 5 ppb
Resolution	0.001 ppbC (µgC/L)
Analysis time	Continuous
Initial response time	< 60 s
Limit of detection	0.025 ppbC

### Conductivity Sensor

Conductivity accuracy	± 2%, 0.02-20 µS/cm; Constant Sensor <sup>a</sup>
Cell constant accuracy	± 2%
Temperature sensor	Pt 1000 RTD, Class A
Temperature accuracy	± 0.25 °C

### Sample Water Requirements

Temperature	0 to 100 °C <sup>b</sup>
Particle size	< 100 micron
Minimum water quality	≥ 0.5 MΩ-cm (≤ 2 µS/cm), pH < 7.5 <sup>c</sup>
Flow rate	≥ 20 mL/min
Pressure	0.3 bar(g) to 6.9 bar(g) (4 to 100 psig) at sample inlet connection <sup>d</sup>

### General Specifications

Case dimensions	280 mm (11") W × 188 mm (7.4") H × 133 mm (5.25") D
Weight	2.3 kg (5.0 lb)
Enclosure material	Polycarbonate plastic, flame retardant, UV and chemical resistant
Ambient temperature/ Humidity rating	5 to 50 °C (41 to 122 °F)/5 to 80 % Humidity, non-condensing
Power requirements	100 – 130 VAC or 200 – 240 VAC, 50/60Hz, 25 W Maximum
Local indicators	Four LED lights for Fault, Error, Sensor Status and UV Lamp ON
Ratings/approvals	CE Compliant, UL and cUL (CSA Standards) listed, Conductivity and temperature sensors traceable to NIST, ASTM D1125 and D5391. Meets ASTM D5173 Standard Test Method for On-line Monitoring of Carbon Compounds in Water by UV Light Oxidation

### Sample Connections

Inlet connection	3 mm (0.125") O.D. (2 m (6") FDA compliant PTFE tubing supplied)
Outlet connection	6 mm (0.25") O.D. Barb connection (1.5 m (5") flexible tubing provided)
Inlet filter	316 SS, in-line 60 micron
Wetted parts	316 SS/Quartz/PEEK/Titanium/PTFE/EPDM/FFKM
Wall mount	Standard, mounting tabs provided
Pipe mount	Optional, with pipe-mount bracket accessory for nominal pipe sizes 2.5 cm (1")
Maximum sensor distance	91 m (300')

<sup>a</sup> Readout in equivalent S/m ranges selectable at M300TOC.

<sup>b</sup> Temperature above 70 °C requires Sample Conditioning Coil (included).

<sup>c</sup> For power plant cycle chemistry samples, pH may be adjusted by measurement after cation exchange.

<sup>d</sup> Process pressure above 5.9 bar(g) (85 psig) requires optional High Pressure Regulator p/n 58 091 552.

For TOC sensors recommended services, see page 209.

Dimensions

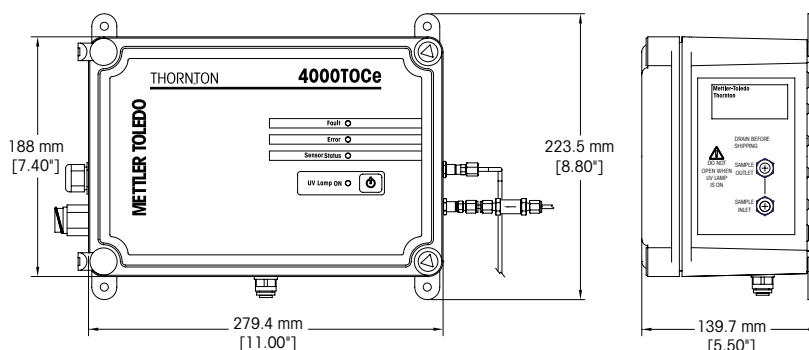

# Total Organic Carbon

A TOC Sensor with Real-Time Continuous Measurement

Total Organic Carbon

## 6000TOC i On-line, Fast and Continuous



The 6000TOC i total organic carbon sensor provides true continuous measurement, refreshing every second, for immediate detection of organic contamination. Its dependable and reliable design uses proven UV oxidation technology for real-time TOC monitoring of your critical water systems. Easily and efficiently monitor TOC levels from post RO waters to point-of-use so you will never miss an excursion. Constructed with the user in mind, its intuitive interface and flexible Plug and Measure design requires no reagents or chemicals for operation.



### Features/Benefits

- On-line continuous measurement
- Meets USP <643>, <645>, EP 2.2.44, Ch.P and JP requirements for the Pharmaceutical Industry
- Semi-automated Calibration and System Suitability Test
- Intelligent Sensor Management (ISM) Interface
- Intelligent diagnostics with iMonitor
- Peak, Average and Rate-of-Change TOC measurement for compliance monitoring
- Compatible with M800 multi-parameter transmitter
- Install up to four TOC sensors to one M800 transmitter
- USB printer capable
- USB for data logging
- Automated flow control
- At-a-glance LED status
- Universal Power Ballast
- 21CFR Part 11 Data Integrity option when paired with an M800 Transmitter and RecordLOC software (see page 235)

### True continuous measurement

With an initial response rate of less than a minute and measurement updates every second, the 6000TOC i is ideal in all pure water applications where rapid detection of TOC changes is critical.

### Stable and reliable analysis

With highly stable and reproducible TOC measurements, you can be confident that you have the control over your water system that is required to meet regulatory and internal water quality specifications.

**Verifiable system performance** Intelligent Sensor Management (ISM) advanced diagnostics help ensure your sensor performs optimally at all times.

### Supports regulatory compliance

For regulated industries, the 6000TOC i Sensor and M800 Transmitter provide the tools necessary to be compliant. They satisfy the requirements of all major global pharmacopeias for TOC instrumentation, including USP, EP, JP, ChP and IP. ALCOA-compliant audit trail for data integrity when paired with an M800 Water 2-channel RecordLOC transmitter and RecordLOC software (see page 235).

► [www.mt.com/6000TOCi](http://www.mt.com/6000TOCi)

## Specifications

### 6000TOCi Sensor

Measurement range	0.05 – 2000 ppbC (µgC/L)
Accuracy	±0.1 ppbC for TOC <2.0 ppbC (for water quality >15 MΩ-cm [0.067 µS/cm]) ±0.2 ppbC for TOC >2.0 ppbC and <10.0 ppbC (for water quality >15 MΩ-cm [0.067 µS/cm]) ±5% of measurement for TOC >10.0 ppbC (for water quality 0.5 to 18.2 MΩ-cm [2.0 to 0.055 µS/cm])
Repeatability	±0.05 ppbC <5 ppbC, ±1.0% >5 ppbC
Resolution	0.001 ppbC (µgC/L)
Analysis Time	Continuous
Initial Response Time	<60 seconds
Update Rate	1 second
Limit of Detection	0.025 ppbC

## Specifications

### Conductivity Sensor

Conductivity Accuracy	±2%, 0.02 – 20 µS/cm ±3%, 20 – 100 µS/cm*
Cell Constant Accuracy	±2%
Temperature Sensor	Pt1000 RTD, Class A
Temperature Accuracy	±0.25°C

### Sample Water Requirements

Temperature	0 to 100°C (32 to 212 °F)**
Particle Size	<100 micron
Minimum Water Quality	≥0.5 MΩ-cm (≤ 2 µS/cm), pH <7.5***
Flow Rate	>8.5 mL/min
Pressure	0.3 bar(g) to 13.6 bar(g)/4 to 200 psig at sample inlet connection****

### General Specifications

Case Dimensions	302.75 mm (11.9") W × 229.8 mm (9") H × 144.7 mm (5.7") D
Weight	5 kg (11.0 lb)
Enclosure Rating	IP55
Enclosure Material	Ignition Resistant Polystyrene Resin meeting UL 94V-0, Painted Aluminum
Ambient Temperature/Humidity Rating	5 to 50°C (41 to 122 °F)/5 to 80% Humidity, non-condensing
Power Requirements	100 – 240 VAC, 50 – 60 Hz, 25W
Local Indicators	Four LED lights for Fault, Error, Sensor Status and UV Lamp ON
Ratings/Approvals	CE Compliant, UL and cUL (CSA Standards) listed. Conductivity and temperature sensors traceable to NIST, ASTM D1125 and D5391. Meets ASTM D5173 Standard Test Method for On-Line Monitoring of Carbon Compounds in Water by UV Light Oxidation

### Installation/Power/Enclosure

Inlet Connection	3 mm (0.125") O.D. (1.83 m [6 ft] FDA compliant PTFE tubing supplied)
Outlet Connection	3 mm (0.125") O.D. (165 mm [6.5"] fixed 316 SS tube provided)
Inlet Filter	316 SS, inline 60 micron
Wetted Parts	316 SS/Quartz/PEEK/Titanium/PTFE/EPDM
Wall Mount	Standard, mounting bracket provided
Maximum Sensor Distance	91 m (300 ft)

\* Readout in equivalent S/m ranges selectable at M800

\*\* Temperature above 70 °C requires Sample Conditioning Coil (included)

\*\*\* For power plant cycle chemistry samples, pH may be adjusted by measurement after cation exchange.

\*\*\*\* Process pressure above 5.9 bar(g)/85 psig requires optional High Pressure Regulator p/n 58 091 552.

Specifications subject to change without notice.

## Total Organic Carbon

A TOC Sensor for Critical Water Release

### Ordering information

Sensor	Order no.
6000TOC i Sensor, 100–240 VAC 50–60 Hz	30 472 150
Transmitter	
M800 Water 2-channel	58 000 802
M800 Water 2-channel RecordLOC	30 656 182
M800 Water 4-channel	58 000 804
M800 DP 2-channel	58 000 806
Accessories	
Pump Module, 6000TOC i	30 472 152
Inlet Filter Assembly, High Capacity	58 091 550
High Pressure Regulator	58 091 552
Accessories – Cords	
Patch Cord, 0.3 m (1 ft)	58 080 270
Patch Cord, 1.5 m (5 ft)	58 080 271
Patch Cord, 3.0 m (10 ft)	58 080 272
Patch Cord, 4.5 m (15 ft)	58 080 273
Patch Cord, 7.6 m (25 ft)	58 080 274
Patch Cord, 15.2 m (50 ft)	58 080 275
Patch Cord, 30.5 m (100 ft)	58 080 276
Patch Cord, 45.7 m (150 ft)	58 080 277
Patch Cord, 61.0 m (200 ft)	58 080 278
Patch Cord, 91.4 m (300 ft)	58 080 279
Consumables & Spare Parts	
Replacement UV Lamp	58 079 513
Calibration Standards	30 472 083
System Suitability Test Standards	30 472 084
Combined Calibration and System Suitability Test Standards	30 472 085
Calibration Standards for Extended Range Calibration	30 472 086
Combined Calibration and System Suitability Test Standards for Extended Range Calibration	30 472 087
Fuse, 1.25A, Sensor PCB	58 091 583
Inlet Filter Replacement	58 091 551

For TOC sensors recommended services, see page 209.

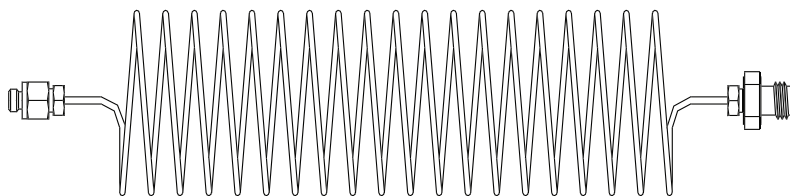

#### Did You Know

The sample conditioning coil optimizes the 6000TOC i sensor performance under adverse conditions such as:

- High sample temperature
- A highly humid environment
- Varying inlet pressure

It also prevents CO<sub>2</sub> ingress into the sample.

### System Suitability Testing

Since the 6000TOC*i* sensor provides continuous monitoring, the system suitability test can be performed far faster than other TOC measurement technologies which rely on lengthy batch measurement or laboratory analysis. During the system suitability test, the operation of the instrument is identical to normal operating conditions with no extra oxidation cycle times. The solutions are easily introduced into the system, and results are available in minutes.

The system suitability test kit from Thornton provides the equipment needed to perform a system suitability test on the 6000TOC*i* Sensor. The system suitability test kit is designed for use with the system suitability standards solutions kit available from Thornton. The Solutions Kit includes one bottle of 500 ppb sucrose, one bottle of 500 ppb 1,4-benzoquinone and two bottles of reagent TOC water. The solutions are produced from USP Reference Standards for assured consistency, quality and compliance.

### Dimensions

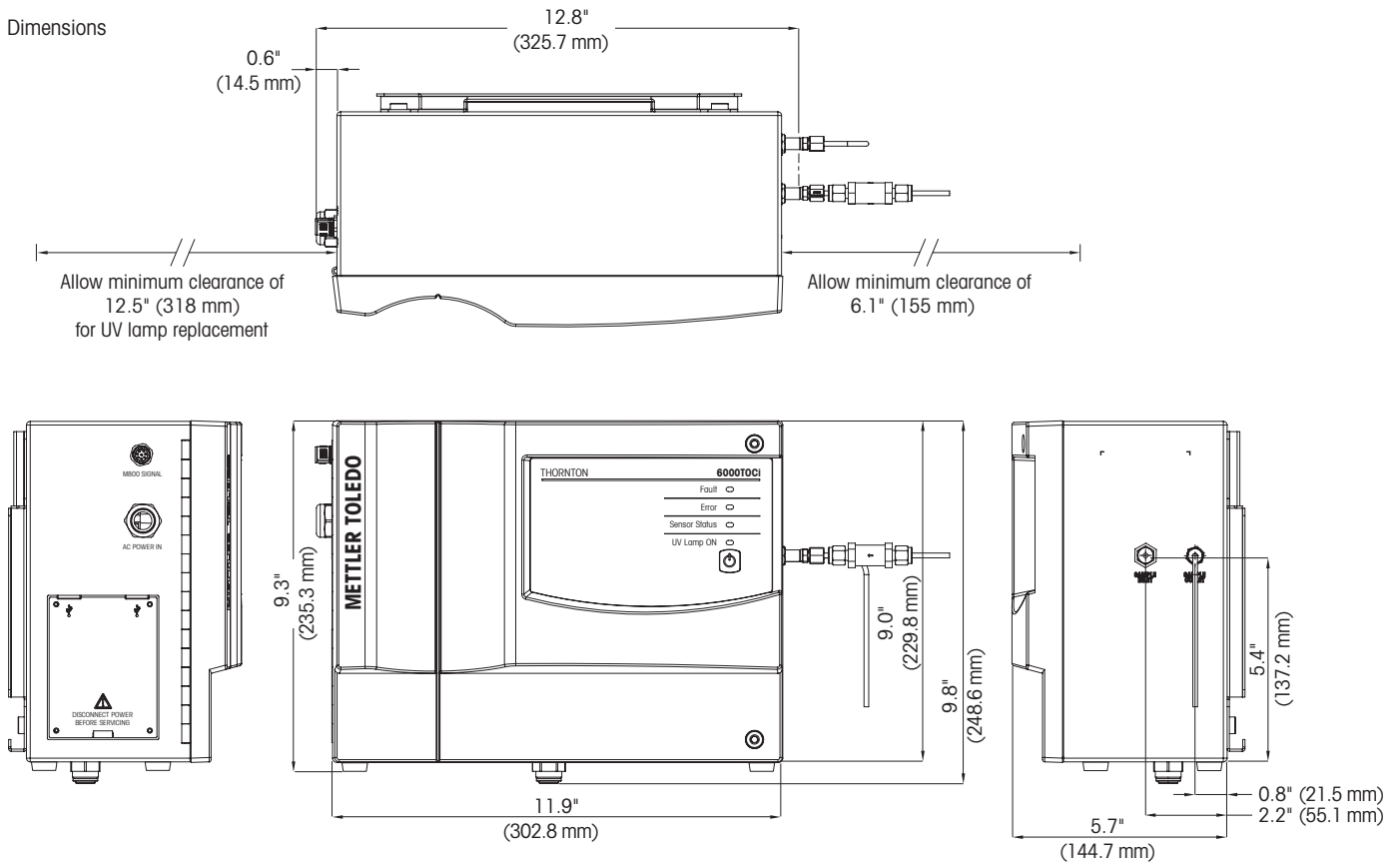

# Total Organic Carbon

A TOC Sensor with Real-Time Continuous Measurement

Total Organic Carbon

## 6000TOC i Low ppb Rapid Detection of TOC Changes



### Features Overview

- On-line continuous measurement
- Semi-automated Calibration
- Intelligent Sensor Management (ISM) Interface
- Intelligent diagnostics with iMonitor
- Peak, Average and Rate-of-Change TOC measurement for compliance monitoring
- Compatible with M800 multi-parameter transmitter
- Install up to four TOC sensors to one M800 transmitter
- USB printer capable
- USB for data logging
- Automated flow control
- At-a-glance LED status
- Universal Power Ballast
- On-site, high precision calibration at low ppb concentrations with certificate of compliance provided

### Real-time Total Organic Carbon Control

The 6000TOCi online sensor delivers true continuous measurement for the detection of organic contamination. With an extremely rapid response to TOC changes, the 6000TOCi is ideal for all pure water applications where rapid detection of TOC changes is critical.

### Real-Time Transparency of TOC Levels

Achieve clear control of your water system with the fastest response time available and measurement updates every second for continuous TOC analysis.

### Conclusive Data to Support Compliance

The 6000TOCi uses proven UV oxidation technology and highly accurate conductivity sensors to deliver consistent and accurate determination of organic material.

### Verifiable System Performance

Using advanced sensor diagnostics, the 6000TOCi gives you the insight needed to ensure your TOC system is always measuring effectively.

### Features/Benefits

Measuring range	0.05 – 2000 ppbC ( $\mu\text{gC/L}$ )
Measurement Range	0.05 ppb – 2,000 ppb
Response Time	60 s
Detection limit	0.025 ppb
Pressure Range	0.3 bar – 13.6 bar (4 psi – 200 psi)
Temperature accuracy ( $\pm$ )	$\pm 0.25^\circ\text{C}$
Analysis Time	Continuous
Limit of Detection	0.025 ppbC
Flow rate	$> 8.5 \text{ mL/min}$
Maintenance	6 mo UV replacement
Weight	6 kg (11.0 lb)
Repeatability	$\pm 0.05 \text{ ppbC} < 5 \text{ ppbC}$ , $\pm 1.0\% > 5 \text{ ppbC}$
Temperature Sensor	PT1000 RTD, Class A
Dimensions W×H×D	302.75 mm × 229.8 mm × 144.7 mm 11.9" × 9" × 5.7"
Online or Portable	Online
Enclosure Material	Powder-coated aluminum back enclosure and polystyrene resin front enclosure.
Initial Response Time	$< 60 \text{ seconds}$
Resolution	0.001 ppbC ( $\mu\text{gC/L}$ )
Operating Range (Temp.)	$0^\circ\text{C} - 100^\circ\text{C}$
Conductivity Accuracy	$\pm 2\%$ , 0.02 – 20 $\mu\text{S/cm}$ $\pm 3\%$ , 20 – 100 $\mu\text{S/cm}$
Cell Constant (accuracy)	$\pm 2\%$
Intelligent Sensor Management (ISM™)	Yes

► [www.mt.com/6000TOCi-low-ppb](http://www.mt.com/6000TOCi-low-ppb)



## Ordering information

Sensor	Order no.
6000TOC i Sensor, Low ppb calibration, 100 – 240 V AC 50 – 60 Hz	30 472 151
Transmitter	Order no.
M800 Water 2-channel	58 000 802
M800 Water 2-channel RecordLOC	30 656 182
M800 Water 4-channel	58 000 804
M800 DP 2-channel	58 000 806
Accessories	Order no.
Pump Module, 6000TOCi	30 472 152
Inlet Filter Assembly, High Capacity	58 091 550
High Pressure Regulator	58 091 552
Accessories – Cords	Order no.
Patch Cord, 0.3 m (1 ft)	58 080 270
Patch Cord, 1.5 m (5 ft)	58 080 271
Patch Cord, 3.0 m (10 ft)	58 080 272
Patch Cord, 4.5 m (15 ft)	58 080 273
Patch Cord, 7.6 m (25 ft)	58 080 274
Patch Cord, 15.2 m (50 ft)	58 080 275
Patch Cord, 30.5 m (100 ft)	58 080 276
Patch Cord, 45.7 m (150 ft)	58 080 277
Patch Cord, 61.0 m (200 ft)	58 080 278
Patch Cord, 91.4 m (300 ft)	58 080 279
Consumables & Spare Parts	
Replacement UV Lamp	58 079 513
Calibration Standards	30 472 083
System Suitability Test Standards	30 472 084
Fuse, 1.25A, Sensor PCB	58 091 583
Inlet Filter Replacement	58 091 551

For TOC sensors recommended services, see page 209.

## 450TOC

### Portable TOC Measurement



The 450TOC Total Organic Carbon analyzer from METTLER TOLEDO Thornton offers the fastest response to TOC changes available in a portable TOC system. With its robust, portable design the 450TOC is an ideal tool for multi-point TOC measurement for point-of-use monitoring, water system diagnostics, and maintenance verification.

#### Portable, Real-time TOC Measurement

- Reduce system and component verification time by 80% with portable, real-time total organic carbon analysis
- Ensure 100% system compliance with fast, simple and easy point-of-use monitoring
- Reduce system diagnostics time by 80% with fast, on-the-spot test results for TOC and conductivity
- Quickly capture and analyze results with on-board USB stick data collection and simple export to spreadsheet programs
- Eliminate costly sampling errors by bringing the measurement directly to the sampling point

#### Other Highlights

- Continuous measurement technology for superior system profiling and performance trending
- USB printer support for hard-copy record keeping
- Compliant with USP, EP, Ch P and JP

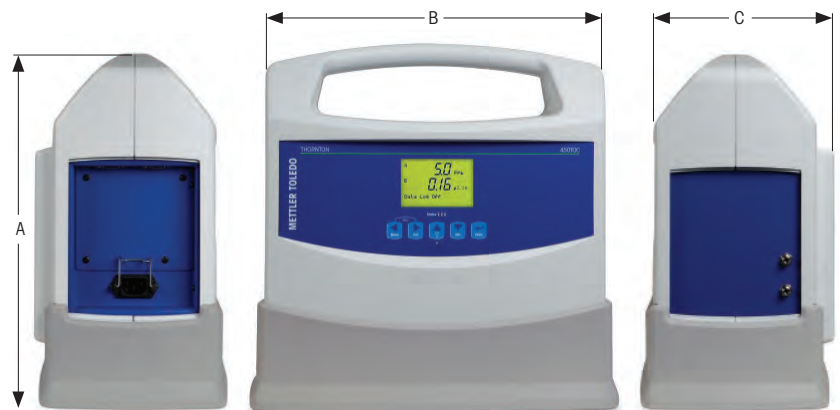

Dimensions	With Base	Without Base
A	349 mm (13.75")	324 mm (12.75")
B	358 mm (14.1")	334 mm (13.15")
C	192 mm (7.56")	185 mm (7.30")

[www.mt.com/450TOC](http://www.mt.com/450TOC)

## Specifications

<b>450TOC Sensor</b>	
Measurement range	0.05 – 1000 µgC/L (ppbC)
Accuracy	±0.1 ppbC for TOC <2.0 ppb (for water quality > 15 MΩ-cm) ±0.2 ppbC for TOC >2.0 ppb and < 10.0 ppb (for water quality > 15 MΩ-cm) ±5 % of measurement for TOC > 10.0 ppb (for water quality 0.5 to 18.2 MΩ-cm)
Repeatability	±0.05 ppbC <5 ppb, ±1.0% >5 ppb
Resolution	0.001 ppbC (µgC/L)
Analysis time	Continuous
Initial response time	<60s
Limit of detection	0.025 ppbC
<b>Conductivity Sensor</b>	
Conductivity accuracy	±2 %, 0.02 to 20 µS/cm; ±3 %, 20–100 µS/cm
Cell constant accuracy	±2 %
Temperature sensor	Pt 1000 RTD, Class A
Temperature accuracy	±0.25 °C
<b>Sample Water Requirements</b>	
Temperature	0 to 70 °C
Particle size	< 100 micron
Minimum water quality	≥0.5 MΩ-cm (≤2 µS/cm), pH < 7.5*
Flow rate	20 mL/min
Pressure	0.3 to 5.8 bar (4 to 85 psig) at sample inlet connection
<b>General Specifications</b>	
Overall dimensions	334 × 185 × 324 mm (13.15" L × 7.3" W × 12.75" H)
Sample connections	3 mm (0.125") O.D. (2 m [6'] FDA compliant PTFE tubing supplied)
Weight	With base: 7.0 kg (15.4 lb); without base: 6.1 kg (13.6 lb)
Wetted parts	316 SS/quartz/PEEK/titanium/PTFE/silicone/FFKM/EPDM
Power requirements	100–240 VAC, 50/60 Hz, 40 W maximum
Ratings/approvals	CE Compliant, cULus Listed. Conductivity and temperature sensors traceable to NIST and ASTM D1125 and D5391 Meets ASTM D5173 Standard Test Method for On-Line Monitoring of Carbon Compounds in Water by UV Light Oxidation

\* For power plant cycle chemistry samples, pH may be adjusted by measurement after cation exchange. Specifications subject to change without notice.

## 450TOC Portable Analyzer Ordering Information

Description	Order Number
450TOC Portable Analyzer	58 036 041
Accessories	Order Number
450TOC protective base	58 091 585
Kit, ISM calibration and System Suitability Test (SST and calibration standards sold separately)	58 091 566
Stand, calibration and System Suitability Test kit	58 091 586
Case, 450TOC storage and transport, hard walled	58 091 587
High pressure regulator	58 091 552

## Recommended TOC Sensors Service Agreements

Description	Order Number
<b>Comprehensive Qualification (EQPac)</b> Installation qualification (IQ) and operational qualification (OQ) using factory calibration data combined with a system suitability test (SST). Includes SST reference solutions.	S39905162
<b>Extended Care</b> Maximize uptime with this full coverage over the first 24 months of your equipment's life. Preventive maintenance services include: visual inspection, full calibration (TOC, conductivity, flow rate, temperature) and replacement UV lamp and filter.	B39950001
<b>Comprehensive Care</b> Continue maximized uptime beyond your system's first 24 months. Preventive maintenance services include: visual inspection, full calibration (TOC, conductivity, flow rate, temperature) and replacement UV lamp and filter.	B39910001
<b>System Suitability Test (for compendial water systems)</b> Ensures that the TOC system meets regulations and provides evidence that the system performance meets compliance requirements for pharmaceutical customers.	S39905157

## TOC Pump Module

### Valveless Design, Drift-Free Performance



The Pump Module uses a precision, positive displacement pump to provide a highly stable, metered flow of process water to the TOC sensor to ensure reliable and consistent TOC measurement performance. This accessory is recommended for applications where system pressure is either too low to provide adequate flow through the TOC sensor, or for low pressure applications where system pressure may vary routinely during operation. The Pump Module is ideally suited for applications such as distillation, RO permeate, CIP and pharmaceutical washing.

#### Features Overview

- Positive displacement pumping mechanism
- Flow rate independent of supply pressure
- Requires only a wetted-suction for operation
- Flow pre-set for 20 ml/min or 8.5 ml/min
- Universal AC supply



#### Installation Diagram

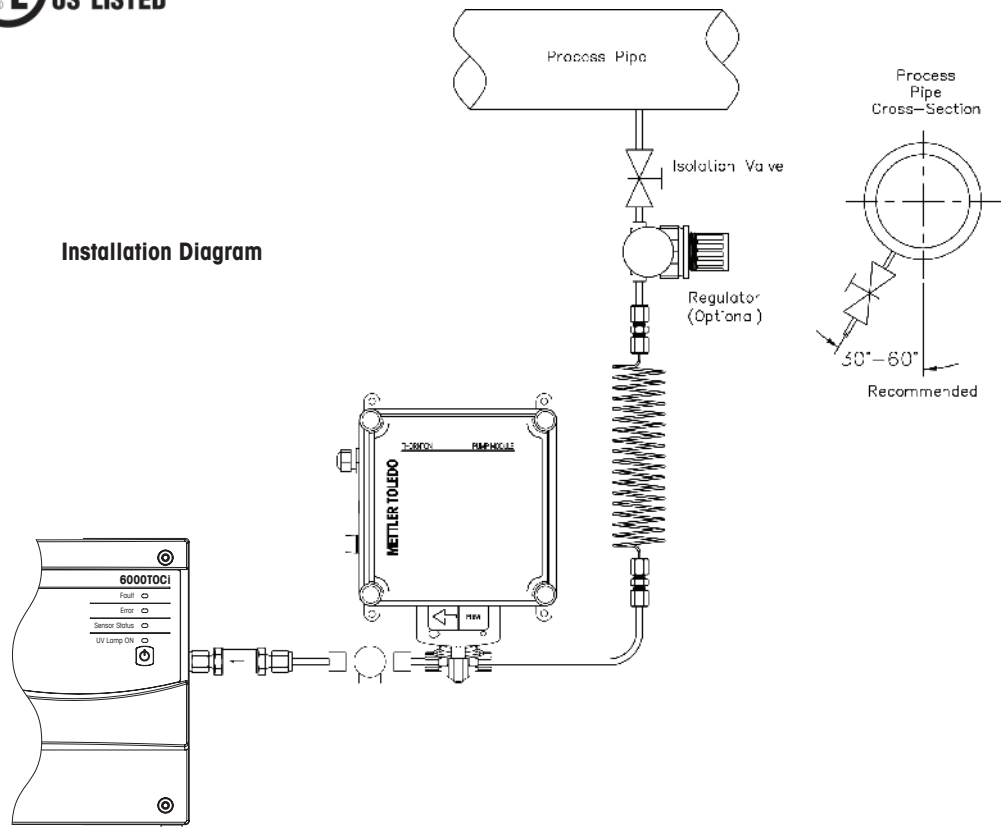

[www.mt.com/Thornton-TOC](http://www.mt.com/Thornton-TOC)

## Ordering Information

Description	Order Number
Pump Module 20 ml/min (for use with the 4000TOCe sensor)	58 091 565
Pump Module 8.5 ml/min (for use with the 6000TOCi sensor)	30 472 152
<b>Pump Module Spare Parts</b>	
Pump Seal Replacement Kit	58 091 020
Replacement Fitting Kit	58 091 021
Replacement Fuse (Fuse rating 250V 0.375A 5 × 20 mm Type 'T' [Time Log])	58 091 024
Pulsation Dampener with Interconnect	58 091 025
Pulsation Dampener Bellows Replacement Kit with Seal	58 091 026

## Specifications

Sample Water Requirements	
Temperature	0 to 100 °C*
Particle size	< 100 micron
Flow rate	20 ± 0.5 ml/min; 8.5 ± 0.25 ml/min
Pressure	Flooded suction to 0.69 bar(g) (10 psig) at sample inlet connection
General Specifications	
Overall dimensions	188 mm (7.4") W × 188 mm (7.4") H × 133 mm (5.25") D
Sample connections	Inlet 3 mm (0.125") O.D. (2 m (6') FDA compliant PTFE tubing supplied) Outlet 3 mm (0.125") O.D.
Weight	2.3 kg (5.0 lb.)
Ambient temperature/Humidity rating	5 to 50 °C/5 to 80 % humidity, non-condensing
Enclosure material	Polycarbonate plastic, flame retardant, UV and chemical resistant UL #E75645, Vol.1, Set 2, CSA #LR 49336
Power requirements	100–240VAC, 50/60 Hz, 0.2A
Wall mount	Standard, mounting tabs provided
Ratings/Approvals	CE Compliant, UL and cUL (CSA Standards) listed. Not NEMA or IP rated

\* Temperature above 70 °C requires Sample Conditioning Coil p/n 58 079 518

## Dimensions

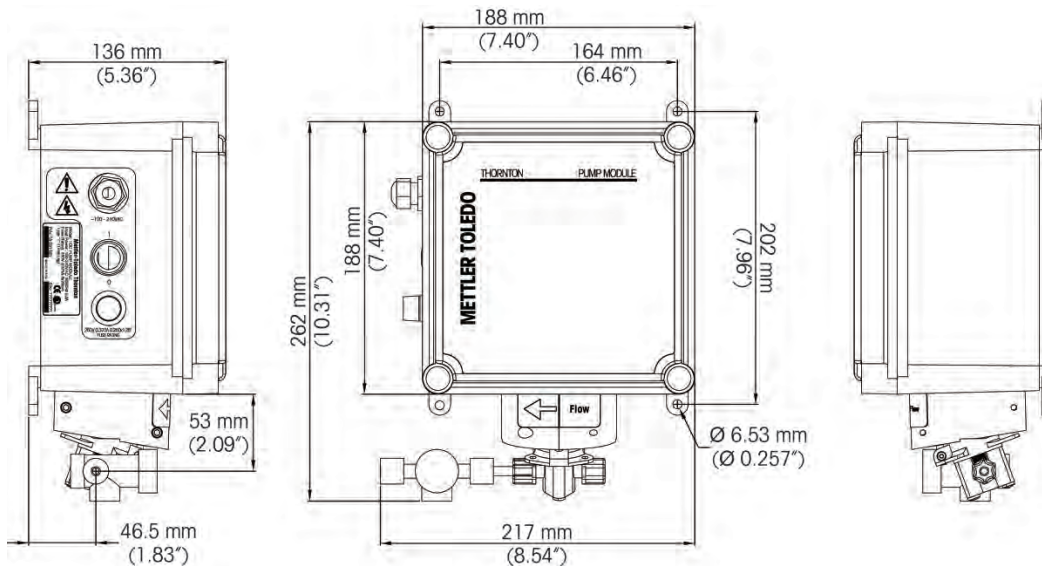

# Microbial Detection Analyzer

Real-time Monitoring of Microbial Contamination

Microbial Contamination

## 7000RMS Microbial Detection Analyzer Continuous, At-line and Dependable

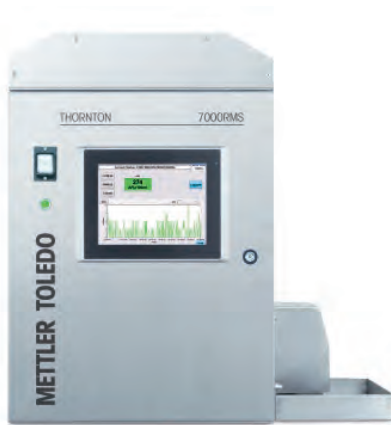

METTLER TOLEDO Thornton's 7000RMS™ (Real-time Microbial System) is an at-line analyzer for real-time measurement of microbial contamination (bioburden) in Pharmaceutical Waters. Advanced, laser-induced fluorescence and Mie scattering measurement technology provides immediate detection and quantification of microorganisms. The compact analyzer overcomes limitations of growth-based technologies that are dependent on incubation conditions, growth media, reagents and time.

The 7000RMS enables risk reduction and greater process control, and offers significant costs savings from the combined decrease in laboratory testing and false-positive results.

### Features/Benefits

- Continuous results every 2 seconds, no incubation or preparation needed
- Laser-induced fluorescence allows for the measurement of AFU
- Detection is not based on organisms forming a colony
- Increase process control by monitoring/reacting to water system trends prior to an out-of-specification event
- Reduce risk of releasing contaminated water
- Convenient touchscreen display with intuitive user interface
- Monitor at-line
- Alarms for alert, action and breach limits
- SCADA connectivity, analog output, Ethernet and Modbus compatible

### Typical Applications

Continuous monitoring of PW, WFI and UPW

- Distribution loops
- Sub loops
- Return loops
- Recirculating storage tanks
- Post purification before storage
- Sampling points

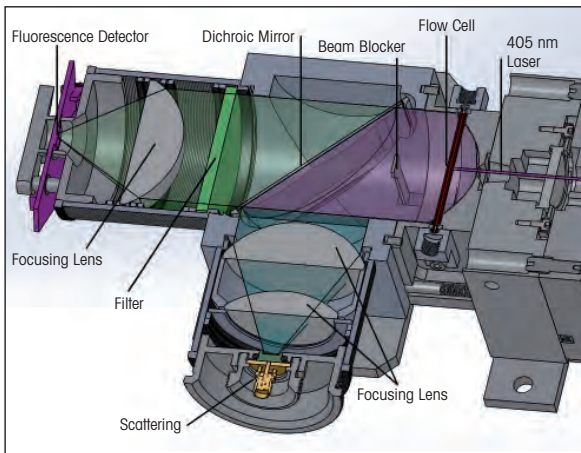

Cross-section drawing of the optical detection system



### Laser Certifications

- The 7000RMS analyzer is certified as a Class 1 laser product.
- The 7000RMS unit contains a Class 3B Laser System, as specified by IEC 60825-1 Ed.3 (2014).

[www.mt.com/7000RMS](http://www.mt.com/7000RMS)



## Specifications

### General Specifications

Flow rate	30 mL/min
Detection limit	1 AFU (Auto Fluorescent Units)
Minimum detection size	≥ 0.3 µm
Response time	2 seconds (1 mL)
Data communication	<ul style="list-style-type: none"> <li>– Ethernet - standard RJ 45 / Wi-Fi capable</li> <li>– SCADA connectivity via Modbus TCP</li> <li>– Analog output channels; 4 – 20 mA standard, with configurable output ranges</li> <li>– USB</li> </ul>

### Water Requirements

Temperature (non-condensing)	5 – 90 °C (41 – 194 °F)*
Inlet pressure	2 – 5.5 bar(g) (20 – 80 psig)** <sup>1</sup>
Type/Quality	Purified Water (PW), Ultrapure Water (UPW), Water for Injection (WFI)

### Power/Installation/Enclosure

Power requirements	100 – 240 VAC, 50 – 60 Hz, 5A Use the power cord included with the instrument 2.5 m (8.2 ft) cord length provided standard
Ambient temperature (non-condensing)	0 – 37 °C (32 – 98.6 °F)*
Inlet connection; Outlet connection	3 mm (0.125") O.D.; 3 mm (0.125") O.D.
Wall mount	Anti-vibration shelf required (P/N 58 079 700)
Enclosure material	Stainless steel
Physical dimensions (W × H × D)	56.4 cm × 61.6 cm × 30.5 cm (22.2" × 24.25" × 12")
Weight	33.3 kg (73.4 lbs)

### Environmental Conditions

Altitude	Up to 2000m (6562 ft)
Environmental Temperature	5 – 35 °C (41 – 95 °F)
Environment	Pollution degree 2
Humidity (non-condensing)	80% maximum relative humidity up to 31 °C (87.8 °F) decreasing linearly to 50% relative humidity at 40 °C (104 °F)
Voltage	MAINS supply voltage fluctuations up to ±10% of the nominal voltage of 100 – 240 VAC 50 – 60 Hz TRANSIENT OVERVOLTAGES: up to levels of OVERVOLTAGE CATEGORY II TEMPORARY OVERVOLTAGES occurring on the MAINS SUPPLY

\* Temperature below 15 °C or above 45 °C requires Sample Conditioning Coil (included)

\*\* Process pressure above 80 psig (5.5 bar(g)) requires optional High Pressure Regulator (P/N 58 091 552). For Process inlet pressure below 2 bar (20 psig use the 700RMS Pump Module Accessory (P/N 30 616 889) [Min pressure ≥ 5psig (0.34 bar(g)); Max pressure ≤ 50psig (3.44 bar(g))]

<sup>1</sup> Calibration, cleaning and grab sample requires sample pressure of 0 psig (0 bar(g))

## Ordering Information

Description	Order Number
700RMS Microbial Detection Analyzer	58 045 001
700RMS Pump Module Accessory	30 616 889

## Recommended Microbial Analyzer Service Agreements

Description	Order Number
<b>Comprehensive Qualification</b> Expert installation ensures that the highest level of quality assurance and documentation is achieved for strictly regulated industries. In-depth user familiarization provides confidence in use and maintenance of the analyzer.	S39905162
<b>Extended Care</b> Ensure peace of mind and maximize uptime with this full service contract over the first 24 months of your analyzer's life. With preventive maintenance right from the start, you minimize possible long term impacts on your analyzer too.	B39950001
<b>Comprehensive Care</b> Continue maximized uptime beyond your systems first 24 months with this comprehensive service offering. Avoid risk and protect your equipment against downtime, performance issues and unexpected repair labor and material costs.	B39910001
<b>Basic Care</b> Service contract provides a faster response time with priority scheduling. It includes full preventive maintenance which covers calibration, inspection, cleaning and operational testing to catch any out-of-specification performance issues.	B39910003

## 2300Na Sodium Analyzer

### High Sensitivity, Low Maintenance



The METTLER TOLEDO Thornton 2300Na Sodium Analyzer offers a new approach for a traditional measurement in pure/ultrapure water treatment and power cycle chemistry monitoring. This analyzer provides assurance of water purity to minimize corrosion and maximize water production during power generation. It also ensures water purity in microelectronics production through early detection of breakthrough in cation resin during ultrapure water treatment. Early detection of trace contamination is enabled with minimal operator supervision.

#### Features/Benefits

- Fully automatic, unattended calibration: ensures reliable operation while saving technician time
- Reagent addition confirmation by pH: ensures reliable measurement results
- Convenient grab sample measurement: for additional samples and QC checks for other areas of the plant
- Slow and complete reagent consumption: saves reagent costs and eliminates waste disposal issues
- Simultaneous display of sodium, adjusted pH, temperature and calibration progress: provides convenient analyzer and sample status at a glance, saving operator time
- Automated electrode conditioning with each calibration: minimizes the need for electrode etching
- Choice of two enclosures: full locking door for dirty plant environments or with controls conveniently accessible for clean sample rooms
- Four analog outputs for sodium, pH and temperature with choice of scaling: enables full integration into data acquisition or control systems

#### Typical Applications

- Ultrapure water monitoring at sub-ppb sodium levels
- Cation exchange monitoring in pure water treatment detects the first breakthrough of sodium
- Power steam quality monitoring protects turbines from sodium attack
- Power condensate monitoring detects small leaks early to allow time to plan corrective action



## Specifications

### Measurements

Response time (90%)	5 min
Update rate	Once per second
Reagent consumption	Diisopropylamine, DIPA, or Ammonium Hydroxide, approximately 0.7 L filling per 2 months; more at higher temperatures and for cation exchange samples
Sample pH	2.5–12
Sample flow rate	> 40 mL/min (> 20 mL/min for cation exchange samples), excess to drain
Sample temperature	5–50 °C (41–122 °F)
Sample pressure	0.3–7 bar(g) (5–100 psig)
Calibration	Automatic, unattended 3-point known addition; manual 1- or 2-point
Electrode conditioning	Part of auto-cal sequence
Grab sample measurement	Included
Range, temperature	0–100 °C (32–212 °F)

### Outputs

Analog outputs	For sodium, conditioned pH, temperature; four powered 0/4–20 mA, 22 mA alarm, 500 ohm max load, not for use with externally powered circuits
Analog output scaling	Linear, bi-linear, logarithmic (1,2,3 or 4 decades) or auto ranging
Analog output accuracy	±0.05 mA
Relay contacts	Two unpowered, SPDT, 250 VAC/30VDC, 3 A resistive freely assignable to setpoints for sodium, pH, temperature; other relays used for auto-cal

### Installation/Power/Enclosure

Operator interface	4-line backlit LCD, 5 tactile keys; simultaneous display of sodium, conditioned pH, auto-cal status (temperature optional)
Connections	Sample inlet: 1/4" or 6 mm OD tube SS compression fitting Drain hose: 19 × 25.4 mm (3/4 × 1"), 2 m (6ft) length included
Power	100–240 VAC, 50–60 Hz, 25 W; on power loss all settings are retained without batteries
Dimensions HWD	Enclosures: 900 × 450 × 190 mm (35.4 × 17.7 × 7.5")
Weight	27 kg (60 lbs)
Ambient operating temperature	10–45 °C (50–113 °F)
Humidity	10–90% non-condensing
Ratings/approvals	CE, cULus

## Ordering Information

Description	Order No.
2300Na Sodium Analyzer, with full dust & water resistant enclosure	58 042 002
2300Na Sodium Analyzer Panel (clean locations)	
100–240 VAC	30 768 009
Required Startup Kit	58 091 233*
1 L of 100 ppm calibration standard solution, 250 mL of 7 and 10 pH buffer solutions and etch solutions	

\* Diisopropylamine (DIPA) reagent to be sourced locally.

For Analyzers recommended services, see page 221.

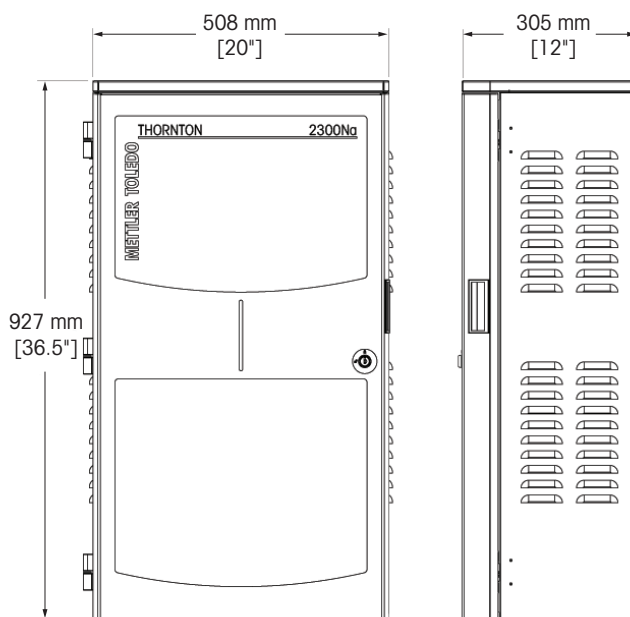

## 2301Na Sodium Analyzer

### Accurate and Reliable Measurement, Solid Value

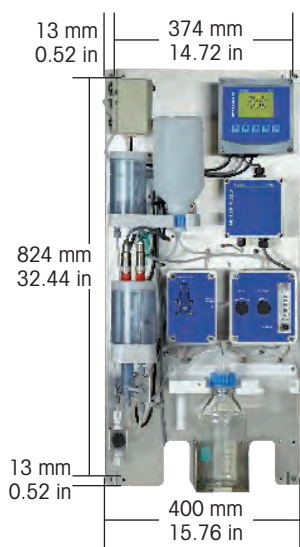

The METTLER TOLEDO 2301Na Sodium Analyzer offers an open panel-mounted design for pure water treatment projects. This analyzer features a measurement range starting at 0.01 ppb for trace measurement applications. This low-maintenance analyzer has a manual calibration process to ensure accurate measurements and to help you identify cation resin breakthrough during pure water treatment. This analyzer offers add-on features to enhance capabilities according to your project's needs.

#### Features/Benefits

- Wide measurement range: 0.01 ppb-100,000ppb assures early detection of trace contamination
- Choice of reagent, DIPA or Ammonium Hydroxide to better comply with plant safety requirements
- pH check verifies reagent delivery assuring reliability of measurement
- Two models available, a panel-mounted assembly or lockable full-door enclosure
- Controlled, efficient reagent consumption eliminates waste disposal issues
- Low maintenance ensures low cost of ownership
- Grab sample capability is available as an add-on option for testing samples in multiple areas of the plant

#### Specifications

Measurements	
Range, sodium	0.01 – 100,000 ppb or equivalent ppm, auto ranging
Resolution, sodium	4 digits with decimal, auto ranging; 0.001 ppb in lowest range
Accuracy, sodium	± 10 % of reading ± 0.1 ppb, typical; using DIPA as reagent ± 10 % of reading ± 1 ppb, typical; using ammonium hydroxide as reagent
Response time (90 %)	5 min
Update rate	Once per second
Reagent consumption	Diisopropylamine (DIPA), or ammonium hydroxide, approximately 0.7 L fillings per 2 months; more at higher temperatures and for cation exchange samples
Sample pH	2.5 – 12
Sample flow rate	> 40 mL/min (> 20 mL/min for cation exchange samples excess to drain)
Sample temperature	5 – 50 °C (41 – 122 °F)
Sample pressure	0.3 – 7 bar(g) [5 – 100 psi(g)]
Calibration	Manual 3-point known addition; manual 1- or 2-point
Grab sample measurement	Available option
Range, pH	0 – 14 pH, reagent conditioned sample
Range, temperature	0 – 100 °C (32 – 212 °F)

## Specifications

Outputs	
Analog outputs	For sodium, conditioned pH, temperature; four powered 0/4–20 mA, 22 mA alarm, 500 ohm max load, not for use with externally powered circuits
Analog output scaling	Linear, bi-linear, logarithmic (1,2,3 or 4 decades) or auto ranging
Analog output accuracy	±0.05 mA
Relay contacts	Two unpowered, SPDT, 250 VAC/30 VDC, 3 A resistive freely assignable to setpoints for sodium, pH, temperature
Installation/Power/Enclosure	
Operator interface	4-line backlit LCD, 5 tactile keys; simultaneous display of sodium, conditioned pH, cal status (temperature optional)
Connections	Sample inlet: 1/4" or 6 mm OD tube SS compression fitting Drain hose: 19 × 25.4 mm (3/4 × 1"), 2 m (6 ft) length included
Power	100–240 VAC, 50–60 Hz, 25 W; on power loss all settings are retained without batteries
Dimensions HWD	851 × 450 × 165 mm (33.5 × 15.75 × 6.5")
Weight	4.5 kg (10 lbs)
Ambient operating temperature	5–50 °C (41–122 °F)
Humidity	10–90% non-condensing
Ratings/approvals	CE, cULus, IP 65, UKCA

## Ordering Information

Description	Order No.
2301Na Sodium Analyzer panel assembly	58 042 003
2301Na Sodium Analyzer with full door enclosure	58 042 004

## Accessories and Consumables

Consumables kit 1 year – Includes sodium and pH electrodes, air filters, sample filter, diffusion tubing, calibration kit, 7 and 10 pH buffer solutions	58 091 111
Calibration kit 1 year – Includes 120 mL of 100 ppm calibration standard, 60 mL of conditioning solution, etch kit	58 091 108
Diisopropylamine (DIPA)	58 140 017
Ammonium Hydroxide 30 %	58 091 114

## Key Power Applications

- **Make Up Water:** Detects cation breakthroughs of sodium ions signaling exhaustion of cation resin.
- **Condenser and Polisher:** Warns of cation breakthrough and condenser leakage.
- **Economizer:** Detects sodium carryover into inlet water before it enters the boiler.
- **Superheater:** Detects sodium carryover into steam to protect turbines.

For Analyzers recommended services, see page 221.



## Did You Know

SQ144 and SQ148 Sequencers offer the capability to measure up to 8 sample streams with a single sodium, silica, chloride/sulfate analyzer. Please speak with your METTLER TOLEDO representative to learn more.

## 2850Si Silica Analyzer

### Intelligent, Flexible, Compact



The METTLER TOLEDO Thornton 2850Si Silica Analyzer is a compact and reliable on-line analyzer designed for measuring silica in pure/ultrapure water treatment and power cycle chemistry monitoring. It supports early detection of trace contamination with minimal operator supervision, proactively monitors reagent usage and reports time to maintenance. This analyzer offers optional built-in sequencing to support multiple sample streams and phosphate monitoring to ensure sufficient levels are maintained for optimal boiler water treatment.

#### Features/Benefits

- Automatic, unattended calibration provides excellent repeatability and saves operator time
- Automatic zeroing with every measurement ensures measurement stability
- Convenient grab sampling allows quality testing of remote samples
- Intelligent internal analytics ensure peak performance and minimal downtime
- Configurable simultaneous display of parameters including silica/phosphate levels and measurement timing
- Analog output with choice of scaling for integration into data acquisition system
- Available as panel assembly or with full enclosure that protects reagent containers and components from plant environment
- Small footprint simplifies upgrades and saves valuable panel space
- Lightweight, compact, simple-to-maintain design supports up to four sample streams

#### Typical Applications

- Anion exchange monitoring in pure water treatment detects the first breakthrough at very low ppb levels of silica to trigger regeneration and ensure contaminated water can be diverted before it reaches critical areas.
- Power steam quality monitoring protects turbines from silica deposition and resulting imbalance, loss of capacity and reduced efficiency. Silica measurement and control may also be needed to meet turbine manufacturer warranty requirements.
- At larger plants, monitoring silica levels at the economizer provides a final feed-water quality check before the pre-heated water enters the steam drum.
- When treating boiler water with phosphate, monitoring ppm levels is important for maintaining appropriate concentrations to control scale and protect against caustic corrosion.

► [www.mt.com/Thornton-silica](http://www.mt.com/Thornton-silica)

## Specifications

### Measurements

Silica measurement range	0–5,000 ppb
Phosphate measurement range	0.3–10 ppm
Silica measurement accuracy	±5% of reading or ±1 ppb, whichever is greater
Phosphate measurement accuracy	±10% of reading or ±0.3 ppb, whichever is greater
Resolution	4 digits with decimal, auto ranging; 0.001 ppb in lowest range
Measurement cycle time	Adjustable ≥ 10 min; 20 min typical
Reagent consumption	Approx. 500 mL each per 3 months with 20 min measurement cycle time
Sample flow rate	50–250 mL/min
Sample temperature	5–60 °C (41–140 °F)
Sample pressure	0.3–7 bar (5–100 psig)
Zero calibration	Automatic, every measurement cycle
Span calibration	Automatic per schedule; once per month, typical
Grab sample measurement	500 mL capacity

### Outputs

Analog output	8 powered 0/4–20 mA, 22 mA alarm, 500 ohm max load, not for use with externally powered circuit
Analog output accuracy	±0.05 mA
Analog output scaling	Linear, bi-linear, logarithmic (1,2,3,4 decades), auto ranging
Relay contacts	4-SPST mechanical rated at 250 VAC, 3 A; 4-SPST Type Reed 250 VAC or DC, 0.5 A
Digital input	Remote start/stop of measurement cycle
Communication	PROFIBUS DP

### Installation/Power/Enclosure

Operator interface	TFT color touchscreen; simultaneous display of silica/phosphate concentration and measurement or auto-cal status
Process connections	Sample inlet: 6 mm or 1/4" OD tube SS compression fitting Drain hose: 19 × 25.4 mm (3/4 × 1"), 2 m (6 ft) length included
Power supply	100–240 VAC, 50–60 Hz, 65 W; all settings retained on power loss
Dimensions HWD	Enclosure: 543 × 396 × 300 mm (21.4" × 15.6" × 11.8")
Weight	18 kg (40 lbs)
Ambient operating temperature	10–50 °C (50–122 °F)
Humidity	10–90% non-condensing
Ingress protection	IP66/NEMA 4X (Electronics); IP55 (Enclosure)
Ratings/approvals	CE, cULus, UKCA

Specifications subject to change.

## Ordering Information

Description	Order No.
Analyzer 2850Si Silica, 1-stream	30 571 931
Analyzer 2850Si Silica, 2-stream	30 571 932
Analyzer 2850Si Silica, 4-stream	30 571 933
Analyzer 2850Si Silica, 1-stream with Phosphate	30 571 934
Analyzer 2850Si Silica, 2-stream with Phosphate	30 571 935
Analyzer 2850Si Silica, 4-stream with Phosphate	30 571 936
Analyzer 2850Si Silica, 1-stream Panel	30 571 937
Analyzer 2850Si Silica, 2-stream Panel	30 571 938
Analyzer 2850Si Silica, 4-stream Panel	30 571 939
Analyzer 2850Si Silica, 1-stream Panel with Phosphate	30 571 940
Analyzer 2850Si Silica, 2-stream Panel with Phosphate	30 571 941
Analyzer 2850Si Silica, 4-stream Panel with Phosphate	30 571 942
Silica Reagent Kit* (3 month supply of reagents and 500 mL of 250 ppb silica calibration standard.)	30 571 930
Silica/Phosphate Reagent Kit* (3 month supply of reagents and 500 mL of 250 ppb silica/1 ppm PO <sub>4</sub> calibration standard.)	30 571 929

\* Reagent Kit determined based on Silica only or Silica/Phosphate measurement models.



## 3000CS Chloride & Sulfate Analyzer

### High Sensitivity, On-line Measurement



The METTLER TOLEDO Thornton 3000CS Analyzer is a reliable on-line instrument designed to directly measure chlorides and sulfates in pure water and power cycle chemistry. This analyzer enables monitoring of these highly corrosive contaminants to assist in corrosion control and minimizing damage to critical plant equipment. Early, unambiguous detection of trace levels of these contaminants is enabled with minimal operator supervision.

#### Features/Benefits

- Intuitive touchscreen interface: allows display of trendlines for each measurement
- Simultaneous display of ion concentrations and measurement timing: provides convenient analyzer status at a glance, saving operator time
- Convenient grab sample capability: allows measurement of additional samples or for QC checks
- Full enclosure: protects internal reagent containers and components from plant environment

#### Typical Applications

- Steam quality monitoring at turbine inlet to ensure chloride and sulfate levels are under acceptable limits.
- Condensate monitoring at condensate polisher, to detect breakthrough or deterioration of sulfonated cation resin.
- Boiler feedwater monitoring, to activate boiler blowdown if needed to control contaminant levels.
- Makeup water quality.

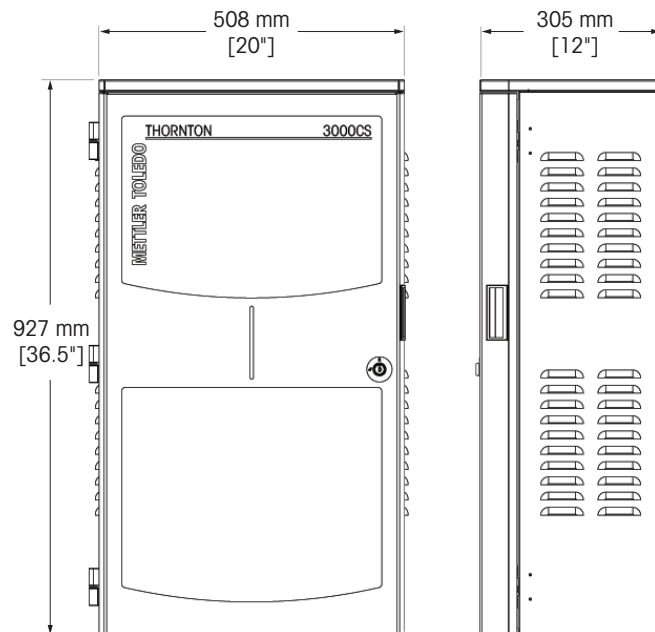

[www.mt.com/Thornton-ion](http://www.mt.com/Thornton-ion)

## Specifications

Measurements	
Range	0–300 ppb
Limit of detection	Chloride: 0.5 ppb; Sulfate: 1 ppb
Accuracy	Chloride: $\pm 5\%$ of reading $\pm 0.5$ ppb, typical; Sulfate: $\pm 10\%$ of reading $\pm 1$ ppb
Measurement cycle time	45 min typical, programmable between 15 minutes and 1 hour
Sample flow rate	25–50 mL/min
Sample temperature	10–45 °C (50–113 °F)
Sample pressure	0.3–7 bar (5–100 psig)
Grab sample measurement	100 mL capacity
Outputs	
Analog outputs	8 powered 0/4–20 mA, 22 mA alarm, 500 ohm max load, not for use with externally powered circuit
Analog output accuracy	$\pm 0.05$ mA
Analog output scaling	Linear, bi-linear, logarithmic (1,2,3,4 decades), auto ranging
Relay contacts	Mechanical rated at 250 VAC, 3 Amps (Relay 1 NC, Relay 2 to 4 NO), 4-SPDT Type Reed 250 VAC or DC, 0.5 Amps (Relay 5 to 8)
Installation/Power/Enclosure	
Operator interface	Color touchscreen; simultaneous display of ion concentrations and analyzer status
Process connections	Sample inlet: ¼" or 6 mm OD tube SS compression fitting Drain hose: 19 × 25.4 mm (¾ × 1"), 2 m (6 ft) length included
Power	100–240 VAC, 50–60 Hz, 100 W typical
Dimensions HWD	927 × 508 × 305 mm (36.5" × 20.9" × 12")
Weight	44 kg (97 lbs)
Ambient operating temperature	10–35 °C (50–95 °F)
Humidity	10–70 % non-condensing
Ratings/approvals	CE, cULus, UKCA

\* Specifications subject to change.

## Ordering Information

Description	Order No.
3000CS Analyzer	58 044 001
Required Consumable Kit	58 091 401
Includes 2-month supply of reagents, cartridge, and calibration standard solution.	
Conditioning Resin Kit	30 416 018

## Recommended Analyzer Service Agreements

Service Description	Order Number
<b>Setup and Configuration</b> Provides fast and reliable setup and standard configuration to ensure the analyzer is ready for use in your application.	S39905182
<b>ExtendedCare</b> Ensure peace of mind and maximize uptime with this full coverage service contract over the first 24 months of your equipment's life. With preventive maintenance right from the start, you minimize possible long term impacts on your equipment too.	B39950001
<b>ComprehensiveCare</b> Continue maximized uptime beyond your analyzer's first 24 months with this comprehensive service offering. Avoid risk and protect your equipment against downtime, performance issues and unexpected repair labor and material cost.	B39910001
<b>BasicCare</b> Service contract provides a faster response time with priority scheduling. It includes full preventive maintenance which covers calibration, inspection, cleaning and operational testing to catch any out-of-specification performance issues.	B39910003

# Transmitters for All Parameters Your Access to Water Analytics

**Whether you require a multi-parameter, multi-channel, parameter specific or portable unit, METTLER TOLEDO's wide portfolio of globally-approved transmitters includes the right solution for you.**

### Constant information

Transmitters are the components that communicate to the user and translate sensor readings into displayed measurements for indication and control. METTLER TOLEDO provides tailorable transmitter solutions to meet the needs of a wide range of applications and functional requirements. Intelligent diagnostics keep users informed of sensor "health".

### Single- or multi-channel?

For simpler processes where only a single parameter requires measurement, a single-channel transmitter is the obvious choice, but for processes where more than one parameter must be monitored, multi-channel, multi-parameter transmitters offer significant advantages and value. METTLER TOLEDO multi-channel transmitters combine operating flexibility with ease of use.

### Communication

We offer transmitters for most common communication protocols for easy interface with your DCS or PLC. Intelligent Sensor Management (ISM) diagnostics data can also be accessed on control systems to provide an overview of the performance of all measurement systems from one point.





### The way forward

Use of digital sensors is becoming increasingly common in the process industries. Many of our transmitters accept traditional analog as well as ISM digital sensors, providing a future oriented investment in your plant. Our latest transmitter developments include the M800 multi-parameter, multi-channel unit. Its large touchscreen

display and intuitive menus save operating time, while predictive maintenance ensures reliability and reduced maintenance. The M300 is flexible, price competitive and offers single and dual channel measurements with ISM or analog sensors. The M200 has been designed around one central requirement: ease-of-use. From system selection to commissioning, operation and maintenance,

all M200 system components are narrowly tailored to include only necessary functions. METTLER TOLEDO Thornton transmitters provide reliable performance for measuring conductivity, total organic carbon (TOC), pH, ORP, dissolved oxygen, dissolved ozone and flow.



	M200 (p. 224–227)	M300 Water (p. 228–231)	M400 (p. 92–95)	M800 Water (p. 232–234)
<b>Channels</b>	1/2	1/2	1	2/4
<b>Plug and Measure</b>	•	•	•	•
<b>Dynamic Lifetime Indicator (DLI)</b>	–	•	•	•
<b>Adaptive Calibration Timer (ACT)</b>	–	•	•	•
<b>Time To Maintenance (TTM)</b>	–	•	•	•
<b>Calibration history</b>	–	•	•	•
<b>iMonitor</b>	–	•	•	•
<b>CIP/SIP/autoclaving counter</b>	–	•	•	•
<b>Power plant calc parameters</b>	•	•	–	•
<b>USP/EP conductivity setpoints</b>	•	•	•	•
<b>Di-Cap™</b>	–	–	–	•
<b>Communication</b>	–	–	HART	Profibus DP, Profinet*, Ethernet/IP*
<b>Panel cutout</b>	½ DIN, ¼ DIN	½ DIN, ¼ DIN	½ DIN	½ DIN
<b>Mixed-mode input</b>	–	•	•	–
<b>PID controller</b>	–	•	•	•
<b>Hold input</b>	•	•	•	•
<b>Analog input</b>	–	–	**	•
<b>Relays</b>	2	4	4	4/8
<b>Analog outputs</b>	2/4	2/4	4	4/8
<b>USB data logging</b>	–	•	•	–
<b>Transmitter Configuration Tool (TCT)</b>	•	•	•	•
<b>Approvals</b>	cULus, CE	cULus, CE	cCSAus Cl 1 Div 2, ATEX Zone 2, CE, NEPSI	cULus, CE
<b>Parameter compatibility (water)</b>				
<b>pH/ORP/pNa</b>	•	•	•	•
<b>Dissolved oxygen</b>				
Amperometric sensors				
Low (High Performance)	•	•	**	•
Optical sensors				
Low (pure ODO)	–	–	**	•
<b>TOC</b>	–	–	–	•
<b>Conductivity 2-e/4-e (analog)</b>	–	•	•	–
<b>UniCond 2-e/4-e</b>	•	•	•	•
<b>Dissolved ozone</b>	•	•	**	•
<b>Flow**</b>	•	–	–	•
<b>21CFR Part 11   RecordLOC</b>	–	–	–	•

\* Model dependent

\*\* Each M800 has two pulse flow input channels. Additional flow sensors can be connected using optional pulse flow adapter. Flow is available on selective M200 models.

## M200: Convenient and Reliable For Basic Water Applications



The METTLER TOLEDO M200 transmitter line provides an exceptional ease-of-use interface for digital conductivity, pH, ORP, dissolved oxygen and ozone measurement. From system selection to commissioning, operation and maintenance, all system components are designed to eliminate any unnecessary functions. Plug and Measure provides maximum compatibility and easy operation for digital sensor operation. Simply connect selected digital ISM or unique to M200 digital easySense sensors and the transmitter does the rest.

### Specifications

#### Enclosure / Power

Operator interface	4 line backlit LCD; 5 tactile keys
Material	Polycarbonate
Weight, ¼ DIN models	0.7 kg (1.5 lb)
Weight, ½ DIN models	1 kg (2.2 lb)
UL electrical environment	Installation (overvoltage) Category II
Ratings/approvals	UL (US & Canada), CE compliant; ¼ DIN: IP 65 (front); ½ DIN: IP 65/UL 4X
EMC emissions	EN61226-1:2013 Class A
Power	Universal 100–240 VAC, 50–60 Hz or 20–30 VDC; 5 W

#### Outputs

Analog outputs (as specified for individual models)	Powered 0/4–20 mA, 22 mA alarm, 500 Ω maximum load; not for use with externally powered circuits
Analog output accuracy	±0.05 mA
Analog output scaling	Linear, bi-linear, logarithmic (1,2,3 or 4 decades), auto ranging
Relays (as specified for individual models)	All contacts are potential free, with adjustable hysteresis and time delay SPDT, SPST NO, SPST NC: 250 VAC/30 VDC, 3 A, resistive SPST reed: 300 VDC, 0.5 A, 10 W
Flow models only	SPST reed: 300 VDC, 0.5 A, 10 W
Service interface	USB, type B connector, for remote configuration and commissioning
Discrete input (as specified individual models)	Accepts dry contact closure for remote flow totalizer reset or for remote PID control auto/manual selection

### Other Highlights

- Digital easySense and ISM sensor compatibility
- Quick setup mode for fast installation
- Digital, backlit, high contrast display

### Features Overview

- Multi-parameter allows up to two user-configurable channels with pre-calibrated sensors
- Selectable conductivity temperature compensation on/off and USP alarm capabilities
- Multi-level password protection against accident accidental changes
- Transmitter Configuration Tool (TCT) software included, for fast, simple and consistent transmitter programming via USB port

▶ [www.mt.com/M200](http://www.mt.com/M200)

## Transmitter Specifications

Outputs		
pH/ORP/Cond/DO/Ozone/Temperature	Single-channel	Two-channel
Setpoints/alarms	4-high, low, outside, between, USP, EP	6-high, low, outside, between, USP or EP
Relays	2 SPDT	2 SPDT
Analog output signals	2	4
Discrete inputs	1	2
Flow	Single-channel	Four-channel
Setpoints/alarms	4-high, low, outside, or between	8-high, low, outside, or between
Relays	2 SPDT, 1 SPST NO, 1 SPST NC	2 SPDT, 1 SPST NO, 1 SPST NC
Analog output signals	2	4
Discrete inputs, for external totalizer reset	1	2

## Flow Transmitter Specifications

Flow rate range	0 to 9999 GPM, L/min, m <sup>3</sup> /hr
Total flow range	0 to 9,999,999 Gallons, 37,850,000 Liters, 37,850 m <sup>3</sup>
RO % recovery range	0 to 100 %
Flow velocity range	Equivalent ft/s, m/s
Frequency range	1 to 4000 Hz
Calculated parameters	Ratio, sum and difference of two flowrates (4-channel)
Resolution	4 significant digits, auto-ranged; up to 8 digits for total flow
Update rate	Display and outputs, once per 2 s
Input pulses	Low < 1.0 volt; high > 1.4 volts (36 volts max.)
Accuracy	± 0.5 Hz
Repeatability	± 0.2 Hz

## Measurement Specifications

See ISM sensor pages for specifications: conductivity pages 166–175, pH/ORP pages 176–185, dissolved oxygen pages 186–191 (note optical dissolved oxygen is not compatible with M200), and dissolved ozone page 192–193.

### M200 Digital easySense Measurement Specifications (only compatible with M200 transmitter models)

#### Selected specifications of easySense conductivity sensors

	71	72	73	77
Type	2-electrode	2-electrode	2-electrode	4-electrode
Cell constant	0,1 cm <sup>-1</sup>	0,1 cm <sup>-1</sup>	0,1 cm <sup>-1</sup>	0.3 cm <sup>-1</sup>
Measuring range	0.01–2000 µS/cm	0.01–2000 µS/cm	0.01–2000 µS/cm	0.02–400 mS/cm
System accuracy	± 3.0 % or better	± 3.0 % or better	± 3.0 % or better	± 5.0 % or better
Temperature compensation	standard high purity, cation, ammonia, Light 84, isopropanol, glycol			
Temperature sensor	30 kOhm NTC	30 kOhm NTC	30 kOhm NTC	30 kOhm NTC
Electrode material	Titanium	Titanium	Titanium	1.4404 SS (316L)
Insertion fitting	¾" NPT	½" NPT	¾" NPT & subm.	¾" NPT
Cable length/Order number				
– 7.6 m (25 ft)	58 031 300	58 031 302	58 031 304	–
– 30.5 m (100 ft)	58 031 301	58 031 303	58 031 305	–
– K8S connector	–	–	–	52 003 810

For transmitter recommended services, see page 234.

# Transmitters

Outstanding Performance, Advanced Electronics

## M200 Digital easySense Measurement Specifications (only compatible with M200 transmitter models) continued

### Selected specifications of easySense pH / ORP, and oxygen sensors

	<b>31</b>	<b>32</b>	<b>33</b>	<b>34</b>	<b>41</b>	<b>21</b>
Parameter	pH	pH	pH	pH	ORP	Oxygen
Measurement range	0–14	0–14	0–14	0–14	± 1500 mV	0.03 ppm – 100% saturation
Temperature	–5–80 °C (23–176 °F)	–5–80 °C (23–176 °F)	–5–80 °C (23–176 °F)	–5–80 °C (23–176 °F)	–5–80 °C (23–176 °F)	0–60 °C (32–140 °F)
Pressure resistance	0–2 barg (0–29 psig)	0–2 barg (0–29 psig)	0–2 barg (0–29 psig)	0–2 barg (0–29 psig)	0–2 barg (0–29 psig)	0.5–2 barg (7–29 psig)
Pressure resistance 0–40 °C (32–104 °F)	0–6 barg (0–87 psig)	–	–	–	0–6 barg (0–87 psig)	–
Reference system	Argenthal (Ag/AgCl)	Argenthal (Ag/AgCl)	Argenthal (Ag/AgCl)	Argenthal (Ag/AgCl)	Argenthal (Ag/AgCl)	–
Reference electrolyte	Gel	Pressurized gel	Pressurized gel	Pressurized gel	Polymer	–
Diaphragm	1 ceramic	1 ceramic	1 ceramic	1 ceramic	Open junction	–
Membrane glass	HA	HA	HF	LoT	– (Platinum ring)	–
Application	General purpose	Harsh processes	HF resistant	Low temperature	General purpose	General purpose
Plug head	K8S, Pg 13.5	K8S, Pg 13.5	K8S, Pg 13.5	K8S, Pg 13.5	K8S, Pg 13.5	K8S, Pg 13.5
Order number	52 003 771	52 003 768	52 003 770	52 003 769	52 003 772	52 206 406

### Selected specifications of easy housings

	<b>easyFit 21</b>	<b>easyFit 22</b>	<b>easyFlow 21, 22</b>	<b>easyFlow 23</b>	<b>easyDip 21, 22</b>
Material	CPVC	Stainless Steel	CPVC	Polysulfone	PVC
Temperature	–5–80 °C (23–176 °F)	–5–100 °C (23–212 °F)	–5–80 °C (23–176 °F)	–5–130 °C (23–266 °F)	0–60 °C (32–140 °F)
Max pressure at	7.0 barg / 65 °C 3.5 barg / 80 °C (100 psig / 149 °F) (50 psig / 176 °F)	10 barg / 100 °C (145 psig / 212 °F)	3.5 barg / 80 °C (50 psig / 176 °F)	7.0 barg / 130 °C (100 psig / 266 °F)	ambient
Order Number	52 403 951	52 403 952	<b>easyFlow 21:</b> 52 403 953 <b>easyFlow 22:</b> 52 403 954	52 403 955	<b>easyDip 21:</b> 52 403 956 <b>easyDip 22:</b> 52 403 957
– US size					
– Metric size					

### Ordering Information

Description		Order Number	Order Number
M200 Digital Transmitter	Outputs	¼ DIN	½ DIN
M200 1-channel Multi-parameter	2 Analog; 2 Relays	52 121 554	52 121 555
M200 2-channel Multi-parameter	4 Analog; 2 Relays	52 121 556	52 121 557
M200 Flow 1-channel	2 Analog; 4 Relays	30 280 748	–
M200 Flow 4-channel	4 Analog; 4 Relays	30 280 749	–

### Sensor Cables for ISM

Conductivity	Order Number
0.3m (1ft)	58 080 270
1.5m (5ft)	58 080 271
3.0m (10ft)	58 080 272
4.5m (15ft)	58 080 273
7.6m (25ft)	58 080 274
15.2m (50ft)	58 080 275
30.5m (100ft)	58 080 276
45.7m (150ft)	58 080 277
61.0m (200ft)	58 080 278
91.4m (300ft)	58 080 279
pH/DO/Ozone	Order Number
1.0m (3ft)	59 902 167
3.0m (10ft)	59 902 193
5.0m (16ft)	59 902 213
10.0m (33ft)	59 902 230
Accessories	Order Number
Panel mount kit for ½ DIN models	52 500 213
Pipe mount kit for ½ DIN models	52 500 212
Adapter, VP to standard, for calibrating conductivity with VP patch cord (analog)	58 080 102
Adapter panel – M200 ¼ DIN to 200CR/2000 cutout	58 083 305

For transmitter recommended services, see page 234.

## M300 Water: Versatile and User-Friendly

### For a Wide Range of Applications and Industries



The multi-parameter M300 Water transmitter line for digital or analog conductivity/resistivity, pH/ORP, dissolved oxygen and ozone measurements offers exceptional measurement performance with excellent user ergonomics.

The high contrast black and white touchscreen display together with the harmonized menu structure for all parameters provides clear indication, with trending capabilities, facilitates navigation while ensuring easy, user-friendly operation. On-line diagnostics information, such as the Dynamic Lifetime Indicator, allows operators to schedule sensor maintenance or replacement. The clearly visible diagnostic information tells you when it's time to do maintenance or calibration of sensors with Intelligent Sensor Management (ISM) technology.

The integrated USB interface allows for data logging or storage of the configuration on a USB flash drive.

#### Specifications

Power supply	80 to 255 VAC, or 20 to 30 VDC, 10 VA
Frequency for AC	50 to 60 Hz
Current output	2 × 0/4 to 20 mA (4 × for dual channel), 22 mA alarm (according to Namur NE43)
Display	4.0" b/w touchscreen, 320 × 240 pixel
Languages	9 (English, German, French, Italian, Spanish, Portuguese, Russian, Japanese and Chinese)
Ambient temperature	-10 to 50 °C (14 to 122 °F)
Relative humidity	0 to 95% non-condensing
Rating	¼ DIN: IP65 (front) ½ DIN: IP65
PID controller	Yes
Control input (Hold)	1 or 2 (dual channel version)
Relays	2 × SPST, 2 × reed
Approvals and certificates	cULus, CE
USB interface	1 × USB Host: Data logging and configuration storage on USB flash drive 1 × USB Device: Software update interface

#### Other Highlights

- Mixed-mode functionality allows the connection of analog or digital ISM sensors
- Full ISM diagnostics available (for ISM sensors)

#### Features Overview

- 4.0" touchscreen interface/display
- Multi-parameter transmitter for conductivity/resistivity, pH/ORP, dissolved oxygen, and ozone
- Available as single-channel or dual-channel transmitters
- PID controller with pulse length, pulse frequency or analog control
- User management available

[www.mt.com/M300](http://www.mt.com/M300)

## Measurement Specifications

<b>Conductivity/Resistivity</b>		<b>Analog</b>	<b>ISM</b>
Ranges	0.01 constant sensor: 0.1 constant sensor: 10 constant sensor: 4-electrode sensor:	0.002 to 200 $\mu\text{S}/\text{cm}$ 0.02 to 2,000 $\mu\text{S}/\text{cm}$ 50 to 40,000 $\mu\text{S}/\text{cm}$ 0.01 to 650 $\text{mS}/\text{cm}$	0.002 to 500 $\mu\text{S}/\text{cm}$ 0.02 to 50,000 $\mu\text{S}/\text{cm}^*$  0.01 to 1,000 $\text{mS}/\text{cm}$
Accuracy	$\pm 0.5\%$ of reading or $0.5\Omega$ , whichever is greater (analog only)		
Concentration ranges of HCl, NaOH, $\text{H}_2\text{SO}_4$	0–20 %, 0–15 %, 0–20 %		
TDS ranges ( $\text{CaCO}_3$ and NaCl)	Cover equivalent conductivity ranges		
Calculated parameters (2-channel)	% Rejection, power plant calculations of pH based on specific and cation conductivity, and $\text{CO}_2$ based on cation and degassed conductivity		
Temperature compensation	Selectable as: Std (standard high purity Thornton/Light), Light 84, Std referenced to $75^\circ\text{C}$ , linear $\%/^\circ\text{C}$ , 50% glycol, 100% glycol, cation, ammonia, isopropyl alcohol, none		
<b>pH</b>			
pH, ORP ranges	–1.00 to 15.00 pH, –1500 to 1500 mV		
Temperature range	–30 to $100^\circ\text{C}$ (–22 to $212^\circ\text{F}$ )		
Accuracy	$\pm 0.03$ pH, $\pm 2$ mV		
Temperature compensation	Automatic/manual for electrode output, plus adjustable solution temperature coefficient for solution ionization effects		
Calibration	1- or 2-point, with auto buffer recognition		
Diagnosics	Selectable continuous checking of membrane resistance and reference diaphragm/junction resistance (with solution ground sensors)		
<b>Dissolved Oxygen</b>			
Ranges	0–20,000 ppb; 0–20 ppm, 0–200 % saturation; resolution 0.1 ppb		
Temperature compensation	Automatic, for membrane permeability and oxygen solubility		
Accuracy	$\pm 1\%$ of reading or $\pm 1$ ppb, system accuracy		
<b>Dissolved Ozone</b>			
Ranges	0–5,000 ppb, 0–5 ppm; resolution 0.1 ppb		
Temperature compensation	Automatic, for membrane permeability and ozone solubility		
Accuracy	$\pm 2\%$ of reading or $\pm 3$ ppb, system accuracy		
<b>Temperature</b>			
Range	–40 to $200^\circ\text{C}$ (–40 to $392^\circ\text{F}$ ); resolution $0.1^\circ$		
Accuracy	$\pm 0.25^\circ\text{C}$ ( $\pm 0.45^\circ\text{F}$ )		
Resolution	$0.01^\circ\text{C}$ for conductivity; $0.1^\circ\text{C}$ for all other parameters		
<b>PID Control</b>			
Display	Auto/manual status and %–output on bottom line of display		
Settings	Auto/manual, setpoint, deadband, non-linear corner points, control limits, proportional gain, integral reset time (min), derivative rate time (min)		
Manual station	Controlled by up/down arrow keys in manual mode; remote auto/manual selection by discrete input		
Control output types	One or two analog signals, relays-pulse frequency, or relays-pulse length		

\* stainless steel sensors 0.02 to 3,000  $\mu\text{S}/\text{cm}$

For transmitter recommended services, see page 234.

# Transmitters

Outstanding Performance, Advanced Electronics

Transmitters

## Measurement Specifications (cont.)

Outputs		
pH/ORP/Cond/DO/Ozone/Temperature	Single-channel	Two-channel
Setpoints/alarms	4-high, low, outside, between, USP, EP	6-high, low, outside, between, USP or EP
Relays	1 SPST NO, 1 SPST NC, 2 SPST reed	1 SPST NO, 1 SPST NC, 2 SPST reed
Analog output signals	2	4
Discrete inputs	1	2

## Ordering Information

Description	Order Number
M300 Water 1-channel, Multi-parameter, ¼ DIN	30 280 776
M300 Water 1-channel, Multi-parameter, ½ DIN	30 280 777
M300 Water 2-channel, Multi-parameter, ¼ DIN	30 280 778
M300 Water 2-channel, Multi-parameter, ½ DIN	30 280 779
M300 Water 2-channel, Cond/Res Analog, ¼ DIN	30 280 774
M300 Water 2-channel, Cond/Res Analog, ½ DIN	30 280 775

## Accessories

Installation accessories for ½ DIN version	Order Number
Pipe mount kit for ½ DIN	30 300 480
Panel mount kit for ½ DIN	30 300 481
Wall mounting kit for ½ DIN	30 300 482
Protective hood	30 073 328



## Ordering Information

### Sensor Cables for M300 (analog)

Conductivity <sup>a</sup>	Order Number	
Connector	Standard	VarioPin (VP) <sup>b</sup>
0.3m (1ft)	58 080 250	–
1.5m (5ft)	58 080 251	58 080 201
3.0m (10ft)	58 080 252	58 080 202
4.5m (15ft)	58 080 253	58 080 203
7.6m (25ft)	58 080 254	58 080 204
15.2m (50ft)	58 080 255	58 080 205
23.0m (75ft)	–	58 080 206
30.5m (100ft)	58 080 256	58 080 207
46.0m (150ft)	58 080 257	58 080 208
61.0m (200ft)	58 080 258	–

### ORP

1.0m (3ft)	59 902 245
3.0m (10ft)	59 902 268
5.0m (16ft)	59 902 292
10.0m (33ft)	59 902 318

<sup>a</sup> 4-E sensors limited to 15.2m (50ft), <sup>b</sup> For VP Conductivity sensors only

### pH/DO/Ozone

#### VarioPin (VP) Cables

– for Use At Standard Temperatures –30 to 80 °C / –22 to 176 °F

	Order Number
1.0m (3ft)	52 300 107
3.0m (10ft)	52 300 108
5.0m (16ft)	52 300 109
10.0m (33ft)	52 300 110
15.0m (49ft)	52 300 144
20.0m (65ft)	52 300 141

### Sensor Cables for M300 ISM

Conductivity	Order Number
0.3m (1ft)	58 080 270
1.5m (5ft)	58 080 271
3.0m (10ft)	58 080 272
4.5m (15ft)	58 080 273
7.6m (25ft)	58 080 274
15.2m (50ft)	58 080 275
30.5m (100ft)	58 080 276
45.7m (150ft)	58 080 277
61.0m (200ft)	58 080 278
91.4m (300ft)	58 080 279

### pH/DO/Ozone

	Order Number
1.0m (3ft)	59 902 167
3.0m (10ft)	59 902 193
5.0m (16ft)	59 902 213
10.0m (33ft)	59 902 230

For transmitter recommended services, see page 234.

# M800 Multi-Parameter, Multi-Channel Transmitter

## Touch the Future



### Features Overview

- Color touchscreen
- Intuitive operation
- Premium ISM functionality
- Multi-parameter measurement
- 2-channel/4-channel versions
- iMonitor predictive diagnostics
- User management and logbook
- Trend display
- Data Integrity option

### Other Highlights

- 8 current outputs, 8 output relays
- Traffic light coded sensor status
- 2 PID process controller
- Ethernet/IP model
- PROFIBUS model
- PROFIBUS-DP model
- IP66 rated, cULus Type 4X

The M800 transmitter series features premium Intelligent Sensor Management (ISM) technology measuring conductivity/resistivity, TOC, pH/ORP, optical and amperometric, dissolved oxygen, dissolved ozone. The multi-parameter transmitter accepts any compatible combination of ISM sensors. Up to four channels of process measurement plus two pulse flow measurements provides immediate Plug and Measure installation and operation, predictive sensor maintenance and dynamic lifetime status. The color touchscreen ensures intuitive operation, with user selectable control and alarm management. One model available with PROFIBUS-DP digital communications. ALCOA-compliant data integrity option available (M800 Water 2-channel RecordLOC).

### Specifications

#### Performance

Measurement parameters	Conductivity/resistivity, TOC, pH/ORP, dissolved oxygen, ozone, temperature and flow
ISM	Advanced diagnostics (Dynamic Lifetime Indicator, Adaptive Calibration Timer, CIP/SIP counter etc.) iMonitor

#### Conductivity/Resistivity

Conductivity ranges (C = cell constant)	<b>2-electrode sensor:</b> C = 0.1: 0.01 to 50,000 µS/cm (20 Ω × cm to 50 MΩ × cm) C = 0.1 sanitary: 0.01 to 3,000 µS/cm (333 Ω × cm to 50 MΩ × cm) C = 0.01: 0.001 to 500 µS/cm (2,000 Ω × cm to 500 MΩ × cm)
	<b>4-electrode sensor:</b> 0.01 to 1,000 mS/cm (1.0 Ω × cm to 0.1 MΩ × cm)

Temperature measuring range	–40 to 200 °C (–40 to 392 °F)
Temperature compensation	Auto/selectable as: Std. (standard high purity water Thornton/Light), Light 84, Std. pure water referenced to 75 °C, linear %/°C (adjustable), 50 % glycol, 100 % glycol, cation, ammonia, isopropyl alcohol, none

#### TOC

Measurement range	0.05 – 2000 ppbC (µgC/L)
-------------------	--------------------------

#### pH

pH range	–1 to 15
ORP input range	–1500 to 1500 mV
pH resolution	Auto/0.001/0.01/0.1/1 (can be selected)
Temperature measuring range	–30 to 150 °C (–22 to 302 °F)
Temperature compensation	Auto/manual/STC

#### Oxygen

Range (amperometric)	0 to 10,000 ppb (µg/L)
Range (optical)	0 to 5,000 ppb (µg/L)
Oxygen resolution	Auto/0.001/0.01/0.1/1 (can be selected)
Temperature compensation	Auto

#### Ozone

Operating range	0 – 5,000 ppb (µg/L); 0 – 5.0 ppm (mg/L) short term; 0 – 500 ppb (µg/L); 0 – 0.5 ppm (mg/L) continuous
-----------------	---

► [www.mt.com/M800](http://www.mt.com/M800)

## General Specifications

Power supply	100 to 240VAC, or 20 to 30VDC, 12 VA
AC frequency	50 to 60 Hz
Current (analog) outputs	8 × 0/4 to 20 mA, 22 mA alarm
Bus communications	Ethernet/IP, PROFINET, PROFIBUS-DP
User interface	Color touchscreen 5.7", Resolution 320 × 240 px, 256 colors
Languages	10 (English, German, French, Italian, Spanish, Portuguese, Russian, Japanese, Korean and Chinese)
Ambient temperature	–20 to 50 °C (–4 to 122 °F)
Relative humidity	0 to 95 %, non-condensing
Rating	IP 66 (when back cover is attached), cULus Type 4X
PID process controller	2
Hold input	Yes
Control input	Yes
Alarm contact	Yes (alarm delay 0 to 999 s)
Relays	Mechanical rated at 250VAC, 3 Amps (Relay 1 NC, Relay 2 to 4 NO); 4 – SPDT Type Reed 250 VAC or DC, 0.5 Amps (Relay 5 to 8)
Setpoints	High, low, between, outside, USP, EP

## Ordering Information

Transmitters	Order Number
M800 Water 2-channel + 2 flow	58 000 802
M800 PROFIBUS-DP Water 2-channel + 2 flow	58 000 806
M800 Water 4-channel + 2 flow	58 000 804
M800 Water 2-channel PROFINET + 2 flow	30 530 026
M800 Water 2-channel Ethernet/IP + 2 flow	30 530 028
M800 Water 4-channel Ethernet/IP + 2 flow	30 530 029
M800 Water 2-channel RecordLOC	30 656 182
Pump Modules	
Pump Module TOC 20 ml/min	58 091 565
Pump Module TOC 8.5 ml/min	30 472 152
Installation Accessories	
Pipe mount kit	52 500 212
Panel mount kit	52 500 213
Protective hood	30 073 328

## ISM Sensor Cables

Conductivity/TOC	Order Number	pH/DO*/O <sub>3</sub>	Order Number
0.3 m (1 ft)	58 080 270	1.0 m (3 ft)	59 902 167
1.5 m (5 ft)	58 080 271	3.0 m (10 ft)	59 902 193
3.0 m (10 ft)	58 080 272	5.0 m (16 ft)	59 902 213
4.5 m (15 ft)	58 080 273	10.0 m (33 ft)	59 902 230
7.6 m (25 ft)	58 080 274	20.0 m (66 ft)	52 300 204
15.2 m (50 ft)	58 080 275	30.0 m (98 ft)	52 300 393
30.5 m (100 ft)	58 080 276	50.0 m (164 ft)	52 300 394
45.7 m (150 ft)	58 080 277	80.0 m (264 ft)	52 300 395
61.0 m (200 ft)	58 080 278		
91.4 m (300 ft)	58 080 279		

\* Except optical DO

## Optical DO

Sensor Cables	Order Number
2 m (6.6 ft)	52 300 379
5 m (16.4 ft)	52 300 380
10 m (32.8 ft)	52 300 381
15 m (49.2 ft)	52 206 422

For transmitter recommended services, see page 234.

## Transmitters

Outstanding Performance, Advanced Electronics

<b>Recommended Transmitter Service Agreements</b>	
<b>Service Description</b>	<b>Order Number</b>
<b>Calibrate Transmitter On-Site</b>	S39905073
<b>Calibrate Custom Certificate</b>	S39905083
Transmitter calibrated according to customer tolerances.	
<b>Full Preventive Maintenance On-Site</b>	S39905133
Measurement signal verified. Electronics calibrated. Relays and analog outputs calibrated. Display cleaned.	
<b>Setup Standard Configuration</b>	S39905182
Transmitter display and outputs programmed.	
<b>Repair On-Site</b>	S39905004
<b>Train Initial</b>	S39905211

## 21CFR RecordLOC

### Multi-parameter Data Integrity for Electronic Records



RecordLOC™ is the METTLER TOLEDO solution for ALCOA-compliant electronic records with data integrity for TOC, conductivity and ozone. Paired with an M800 Water 2-channel RecordLOC transmitter and any of the above mentioned sensors, RecordLOC provides audit trail controlled data integrity to your water system.

#### Features/Benefits

- Easy to install and maintain on a PC
- Provides ALCOA-compliant data integrity
- Three-level user accounts including Super User, Admin and User
- Encrypted and password protected audit trail
- Data is stored on a local PC, not on the transmitter for ease of access
- Multi-language support for your global organization

## 21CFR | RecordLOC™

Requires M800 Water 2-channel RecordLOC transmitter (30 656 182) and any of the supported sensors including 6000TOCi, PureO<sub>3</sub> and UniCond.

To download RecordLOC for free, visit:

► [www.mt.com/RecordLOC](http://www.mt.com/RecordLOC)

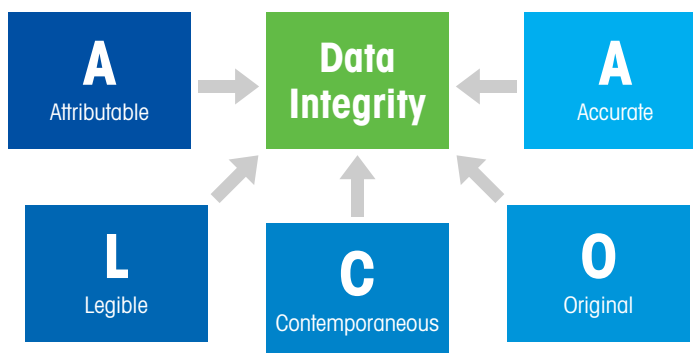

ALCOA is used in regulated industries as a framework to ensure that data is reliable and accurate.





# Downstream Process Analytics for Biopharmaceutical Applications

## Introduction

Unmatched Accuracy in Single-Use Pressure Sensors

# Single-Use Pressure Sensor

## Simplify Your Pressure Measurements

**Pendotech has developed a line of Single-Use Pressure Sensors that offer an accurate and cost-effective solution for measuring pressure in biopharmaceutical processes.**

### Reliable Cost-effective Pressure Measurement

Single-Use Pressure Sensors measure static and dynamic pressure of gases and liquids in your biopharmaceutical processes – accurately and cost effectively.

### Simplified Maintenance

Robust enough to be repeatedly cleaned and inexpensive enough to be utilized in single-use applications, our Single-Use Pressure Sensors deliver a dependable alternative to stainless steel pressure transducers.

### High Measurement Stability

The sensors feature Pendotech High Accuracy Pressure (MEMS-HAP) Chips and are perfect for filtration and chromatography processes as well as monitoring of single-use bioreactors, filling operations and more. They are available in caustic-resistant polysulfone to withstand sanitization processes.

### Versatile

Single-Use pressure sensors, which are qualified for use up to 5.17 bar (75 psi), are compatible with PressureMAT™ monitor/transmitter, Process Control Systems or other pre-qualified third-party monitors.



PREPS-N-050



PREPS-N-1-1



PressureMAT Monitor





Application	Description
Filtration system pressure monitoring	Single-Use Pressure Sensors can be used to monitor the TMP pressure in filtration systems to detect filter plugging and automatically adjust flow rates.
Chromatography system pressure monitoring	Single-Use Pressure Sensors can be used to monitor the pressure in chromatography systems, which is important to detect over pressurization and ensure optimal performance of the column.
Filling operations pressure monitoring	Single-Use Pressure Sensors can be used to monitor the pressure in filling operations, which is important for ensuring that the filling process is operating effectively.
Bioreactor pressure monitoring	Single-Use Pressure Sensors are crucial for monitoring pressure in bioreactors. They help detect over-pressurization due to plugged vent filters which can lead to hazardous situations and loss of product.
Other bioprocess applications	Single-Use Pressure Sensors can also be used in other bioprocess applications, such as centrifugation, virus inactivation and diafiltration.

#### Transmitter selection

Pendotech PressureMAT transmitters are available to work with our Single-Use Pressure Sensors including the Pressure Sensor Transmitter (known as the PT card).

#### Sensor selection:

##### Hose barb connections

These connections are quick and easy to make, making them a good choice for applications where frequent connections and disconnections are required. They are also recommended for pre-assembled, pre-sterilized, single-use tubing and bag assemblies.

##### Sanitary flange connections

These connections are more secure than hose-barb connections, and they are less likely to leak. They are also easier to clean and sterilize, which is important in the biopharmaceutical industry. However, they are more expensive and time-consuming to install.

##### Luer connections

These connections are the smallest and most compact of the three types. They are often used in applications where space is limited. However, they are not as secure as other types of connection.

##### Validation

100 % tested for accuracy and leaks during manufacturing. Available in polycarbonate or caustic resistant polysulfone materials. Certificate of Quality included with lot certification; individual NIST Certificates are optional.

##### Integration flexibility

The Single-Use Pressure Sensors can be integrated with a variety of systems, including: The PressureMAT monitor/transmitter Process Control Systems and third-party monitors.



Single-Use Pressure Sensors come in a variety of sizes starting at 1/8 inch hose barb to 1 1/2 inch sanitary flange

# Single-Use Pressure Sensors

Disposable, Reliable and Disposable

Single-Use Pressure Sensors

## Single-Use Pressure Sensor Simplify Your Pressure Measurements



### Features Overview

- Available in hose-barb connections, sanitary flange & luer connections
- Can be cleaned and re-used
- Unobstructed flow path provide reduced hold-up volume
- Available in polycarbonate or caustic resistant polysulfone materials
- Certificate of Quality included with lot certification; individual NIST Certificates are optional
- Can be non-invasively tested in-place via test port

The Single-Use pressure sensors measure static and dynamic pressure of gases and liquids in your processes accurately and cost effectively. They are perfect for filtration and chromatography processes, monitoring of gases and single-use bioreactors, filling operations and more. They feature the High Accuracy Pressure (MEMS-HAP) chips inside. The sensors connect to monitors via an integral connector. Suitable transmitters include PressureMAT monitor/transmitter, a Process Control System, or other pre-qualified third-party monitors. They can be non-invasively tested in-place with the Pendotech PressureChecker. They are the alternative cost effective solution for use with tubing to the existing stainless steel pressure transducers on the market.

### Specifications

Accuracy	Positive Range	Specification
	0 to 0.41 bar (0 to 6 psi)	±2 % of reading
	0.41 to 2.07 bar (6 to 30 psi)	±3 % of reading
	2.07 to 4.14 bar (30 to 60 psi)	±5 % of reading
	Vacuum Range	Specification
	0 to –0.48 bar (0 to –7 psi)	±3 % of reading
	–0.48 to –69 bar (–7 to –10 psi)	±5 % of reading
Pressure Range	0.79 to 5.2 bar (–11.5 to 75 psi)	
Biocompatibility	All materials in contact with product fluid path meet USP Class VI requirements, both pre and post irradiation	
Regulatory and Compliance Testing	• USP Class VI	• USP 661
	• ISO 10993-5	• Bioburden
	• ADCF	• REACH Compliant
	• Particulates	• Endotoxin
	• Bacteriostatis and Fungistatis (B&F)	• RoHS Compliant
Manufacturing Environment	ISO 9001 certified facility, Class 7 clean room	
Gamma Irradiation	Up to 50 kiloGrays	
X-ray Irradiation	Up to 50 kiloGrays	
Operating Temperature	2 °C to 40 °C (5.6 °F to 104 °F) other ranges with process qualification	
Storage Temperature	–25 °C to 65 °C (–13 °F to 149 °F)	
Input/Output Impedance	270 Ohms to 400 Ohms	
Excitation Voltage	2.5 to 10 volts DC (for best long term stability, use a lower excitation voltage)	
Sensor Output	0.2584 mV/Volt/psi	
Connector	Rating: IP67 when connected to reusable cable	
Shelf Life	5 years	
Packaging	White Tyvek and clear pouch with easy-open chevron seal; box of 25 sensors in polyethylene bags (except sterile sensors are not in polybags)	

► [www.pendotech.com/pressure](http://www.pendotech.com/pressure)

## Ordering Information

Luer Sensors	Order Number
Single-Use Pressure Sensor, polycarbonate, with luer – Sterile	PRESS-S-000
Single-Use Pressure Sensor, polysulfone, with luer – Non-sterile	PREPS-N-000
0.64 × 0.64 cm (¼ in × ¼ in) polycarbonate adapter tee with luer port	PDKT-103-03
0.95 × 0.95 cm (3/8 in × 3/8 in) polycarbonate adapter tee with luer port	PDKT-104-03
1.28 × 1.28 cm (½ in × ½ in) polycarbonate adapter tee with luer port	PDKT-105-03
Polysulfone 3-way stopcock with M/F luer inlet / outlet F branch	PDKT-V3PS-000

## Hose Barb & Sanitary Flange (non-sterile)

### Polysulfone

0.318 cm (1/8 in) hose barb	PREPS-N-012
0.64 cm (¼ in) hose barb	PREPS-N-025
0.95 cm (3/8 in) hose barb	PREPS-N-038
1.28 cm (½ in) hose barb	PREPS-N-075
2.54 cm (1 in) hose barb	PREPS-N-100
1.28 cm (½ in) sanitary flange	PREPS-N-5-5
2.54 cm (1 in) sanitary flange	PREPS-N-1-1
3.81 cm (1 ½ in) sanitary flange	PREPS-N-15-15
2.54 cm (1 in) sanitary flange to 2.54 cm (1 in) hose barb	PREPS-N-1-100
1.28 cm (½ in) sanitary flange to 0.95 cm (3/8 in) hose barb	PREPS-N-5-038
1.28 cm (½ in) sanitary flange to 1.28 cm (½ in) hose barb	PREPS-N-5-050

### Polycarbonate

0.64 cm (¼ in) hose barb	PRESS-N-025
0.95 cm (3/8 in) hose barb	PRESS-N-038
1.28 cm (½ in) hose barb	PRESS-N-050
1.91 cm (¾ in) hose barb	PRESS-N-075
2.54 cm (1 in) hose barb	PRESS-N-100

## Reusable Cable

Cable Adapter for Single-Use Pressure Sensor – 3.657 m (12 ft)	PDKT-650-298
Cable Adapter for Single-Use Pressure Sensor – 7.31 m (24 ft)	PDKT-650-298-24
Cable Adapter to Minim 2 for Single-Use Pressure Sensor – 0.3 m (1 ft)	PDKT-650-298M2
Cable Adapter with RJ12 phone connector to Midgee Monitor for Single-Use Pressure Sensor – 2 m (6 ft)	PDKT-650-298MG
Cable Adapter with RJ12 phone connector to Pall Minim for Single-Use Pressure Sensor – 2 m (6 ft)	PDKT-650-298MN

## Test Cable

Single-Use Pressure Sensor with 0 to 0.41 bar (0 – 6 psi) NIST certificate	PMAT-TCA
--	----------



Flange to Hose Barb Sensor



Luer Sensor



### Did You Know

The Pressure Sensors are 100% tested for critical quality attributes.

- Each sensor is leak tested on the liquid side at 60 psi to confirm integral assembly
- Sensors with a test port are leak tested on the test port side to confirm proper atmospheric reference
- Each sensor is tested electrically to confirm proper electrical performance
- Each sensor is tested to be accurate at 4.14 bar (60 psi) within ±5% of reading (±0.21 bar/-3.0 psi)

## PressureMAT Sensor Transmitter

### Designed for Single-Use Pressure Sensors

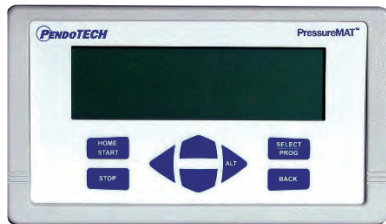

#### Features Overview

- Portable and lightweight
- Interfaces with pumps, valves, and PCs
- Displays Delta-Pressure or TMP (PMAT3 and PMAT4)
- Measures total flow volume (PressureMAT PLUS)
- Interfaces with other sensors with a 4–20 mA output (PressureMAT PLUS)
- Transmitter function delivers a 4–20 mA output signal
- RS-232 data output for data collection

#### Other Highlights

- Perfect for use with filtration and chromatography processes, as well as bioreactor pressure monitoring
- Data output capability to a PC or control system
- User configurable min/max set-points with alarm output signal
- Panel mount option with IP66 NEMA4X Front Panel
- High Resolution (HR) model available for low pressure applications that achieves 10× the accuracy of the standard unit
- IQ/OQ Protocol available

The PressureMAT (PMAT) and the PressureMAT PLUS are both monitor, alarm, and transmitter units designed for use with the Single-Use Pressure Sensors. These lightweight, portable units can easily be moved around a lab or pilot plant to the location where pressure measurement is required. The transmitters use state of the art, solid state electronics, which require no calibration or maintenance. The output options simplify integration to PCs or higher level control systems, and a relay switch enables interfacing with pumps and valves. Options include models with up to four pressure sensor inputs. The PMAT3 and PMAT4 models can optionally display Delta-Pressure of P1 - P2 or trans-membrane pressure (TMP) for filtration processes. These calculated values can also have alarm set-points and the values can be transmitted.

The PressureMAT PLUS system is comprised of the monitor with user interface, and connectors on the back panel where input and output components can be interfaced. It has the ability to measure total flow volume in addition to flow rate. The models with an analog input can be used to interface other sensors with a 4–20 mA output, such as temperature, UV, conductivity, pH and turbidity.

Both systems have an alarm function where minimum and maximum values are entered on the key pad and if the process value goes below the minimum setting or above the maximum setting, the system will go into an alarm state. The alarm state may be tied to the relay output to help safeguard the integrity of a process. The transmitter function delivers a 4–20 milliamp output signal corresponding to the process values on the display. The RS-232 data output to a PC is available for data collection to the PMAT Data Acquisition Software.

There are numerous applications in biopharmaceutical production processes where these units can be used to monitor pressure, including filtration, chromatography, bioreactor monitoring, perfusion, and fill finish operations.

► [www.pendotech.com/pressuremat](http://www.pendotech.com/pressuremat)

## PressureMAT

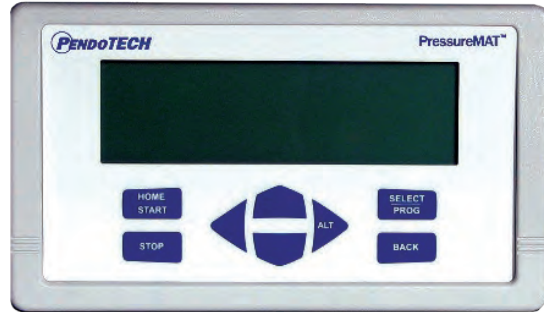

## PressureMAT PLUS

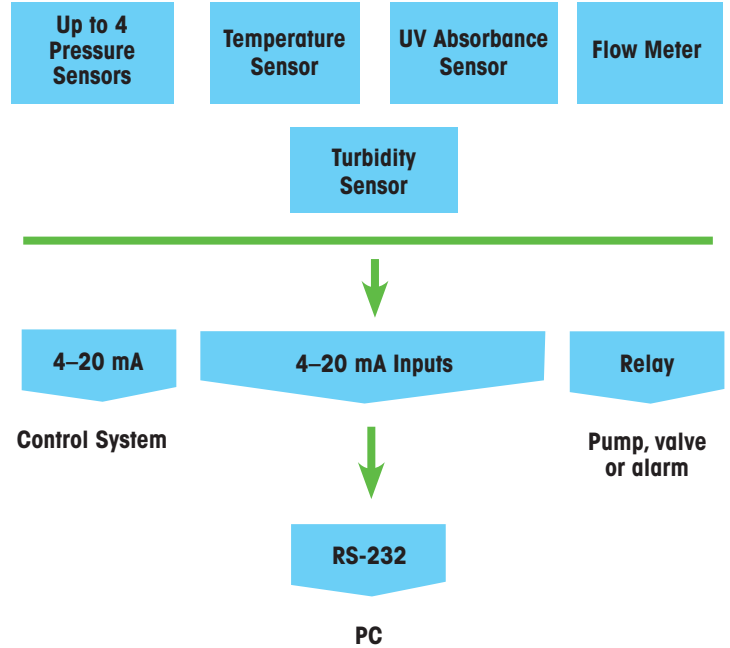
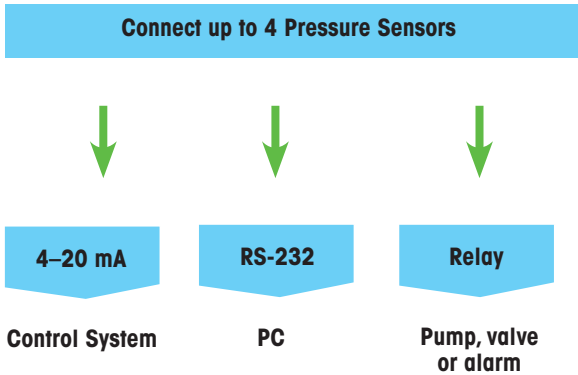

**?** **Did You Know**  
The PressureMAT-S is a portable monitor, alarm, and transmitter ideal for applications which are space limited and require for only 1 sensor. The PressureMAT-S also provides the option for remote tare.



**?** **Did You Know**  
PressureMAT Sensor Transmitter, with a DIN rail mounting design, connects to the Single-Use Pressure sensor and produces a 4-20mA signal linear with pressure, offering five options for optimal performance based on pressure range.



## Specifications

Enclosure (PMAT)	WXDXH 19.96 × 11.35 × 5.72 cm (7.86 × 4.47 × 2.25 in) Approx Weight: 0.65 kg (1.3 lbs) Material: ABS Plastic IP66/NEMA 4X front panel; panel and wall mount optional
Enclosure (PMAT-S)	11.94 × 11.94 × 5.72 cm (4.70 × 4.70 × 2.25 in) Approx Weight: 0.39 kg (0.86 lbs)
Keypad	8 button keypad with LEXAN® overlay
Display	8 line LCD backlit blue, pressure displayed as X.XX bar/X.X psi; PMAT2HR & PMAT-SHR X.XXX bar/X.XXX psi
Power Inlet	2.5 mm (0.04 in) Circular Power Jack (center post positive) or D9 12–24 VDC, 4 watts (powered by wall supply)
Pressure Sensors Input (s) Models offered with 1-4 inputs	Range of –0.793 bar to 5.171 bar (–11.5 to 75.0 psi) PMAT2HR & PMAT-SHR –0.0483 bar to 0.510 bar (–0.7 to 7.5 psi) Configured for Single-Use Pressure Sensors, Connector: DA15 (includes 3.657 m (12 ft) reusable cables)
Relay Outputs(s) [Up to 4 outputs available as a combination of Relay and Analog outputs]	Specifications for relay used for the alarm output: <ul style="list-style-type: none"> <li>• Normally CLOSED or OPEN via wiring</li> <li>• 1 amp closure, 2 amps maximum current</li> <li>• 28 Volt AC/DC Maximum</li> <li>• 20 millisec max turn on/off time</li> </ul> Configured for Single-Use Pressure Sensors, Connector: DA15 (includes 3.657 m (12 ft) reusable cables)
Analog Output(s) [4-20 mA] [Up to 4 outputs available as a combination of Relay and Analog outputs]	Screw terminal connector 4–20 mA Range: –0.689 bar to 5.171 bar (–10 to 75 psi) PMAT2HR & PMAT-SHR –0.069 bar to 0.207 bar (–1 to 3 psi) Accuracy: 0.1 % of full scale Sourcing with Maximum Load: 400 ohms Load Impedance: Zero Ohm minimum resistance, 22 mA maximum output
RS232 Output	Data output to a PC at frequency up to approx every 2 seconds Optional Internal Data Logger: Part# PDKTP-DLOG (logger not available with PMAT-S)
Regulatory Compliances	CE Mark EN61326-1:2013; EN61010-1:2010; EN/ISO13489-1:2009; EN60204-1:2009 FCC Part 15 Class B verified RoHS and REACH Compliant

## Ordering Information

### PressureMAT

Number of Inputs	Number of Outputs	Order Number
1	2 (1 Relay/1 Analog)	PMAT-S
1	2 (1 Relay/1 Analog)	PMAT-SHR
2	4 (2 Relays / 2 Analogs or 4 Relays)	PMAT2
2	4 (2 Relays / 2 Analogs or 4 Relays)	PMAT2HR
2 Pressure Sensor / 1 Flow Meter / 1 4–20 mA	4 (4 Analogs)	PMAT2P
2 Pressure Sensor / 2 4–20 mA	4 (4 Analogs)	PMAT2A
2 Pressure Sensor / 2 Flow Meters	4 (4 Analogs)	PMAT2F
3	4 (3 Analogs / 1 Relay – for all sensors)	PMAT3
3 Pressure Sensor / 1 Flow Meter	4 (4 Analogs)	PMAT3P
3 Pressure Sensor / 1 4–20 mA	(4 Analogs)	PMAT3A
4	4 (4 Analogs)	PMAT4A
4	4 (4 Relays)	PMAT4R



## Ordering Information

Software	Order Number
Data Acquisition and Trending Software for PressureMAT and CMONT with 2 USB/serial cables to connect to a PC	PMATP-GUI
PressureMAT Internal Data Logger (not available with PMAT-S)	PDKTP-DLOG
<b>Stands/Cart</b>	
PressureMAT Benchtop Stand for all models	PMAT-STND
PressureMAT water-tight box (PMAT NOT included) with water-tight cable connections and cart with power strip & filter holder with optional touch-screen PC with Data Acq Software	PMAT-CART4
<b>Water Tight Enclosures</b>	
PressureMAT water-tight wall mount box with water-tight cable connections	PMAT-WALL
PressureMAT water-tight bench top stainless steel box with water-tight cable connections for PMAT on left side	PMAT-BNCH-IP-L
PressureMAT water-tight wall mount box with water-tight cable connections – holds 2 PressureMATs	PMAT-WALL2
PressureMAT-S single channel water-tight wall mount box with water-tight cable connections for PMAT	PMAT-WALL-S
PressureMAT, CMONT with UV Optional water-tight bench top stainless steel box with water-tight cable connections on left side	PMAT-BNCH-COMBO
PressureMAT UL Type 4X Deep-Hinged window kit with a viewing area of 20.32 cm × 22.86 cm (8 in × 9 in) (UL)	PMAT-ULT4X-W1
PressureMAT Silicone Sealant cartridge, clear, 10.1 oz for panel mount installation	PDKT-SIL-SEAL1
<b>Cables</b>	
RS232 Cable for PressureMAT data output (2 m/6 ft) for USB input to PC	PDKTP-RS232U
Cable adapter with D15 for Single-Use Pressure Sensor for PMAT (4 m/12 ft)	PMAT-650-298
Cable adapter with D15 for Single-Use Pressure Sensor for PressureMAT (7 m/24 ft)	PMAT-650-298-24F
Pressure Sensor Extension Cable (4 m/12 ft)	PMAT-EXT-12F
RS232 Serial to USB adapter, for PMAT Wall/ Benchtop box (2.13 m/7 ft)	PMAT-WALL-RS232USB
PMAT Enclosure Box replacement power supply, 12VDC w/ global plug blades	PMAT-PWR-WALL-24VDC
<b>Accessories</b>	
Pressure Checker pressure sensor and monitor verification tool, psi	PDKT-650-950
Pressure Checker pressure sensor and monitor verification tool, millibar	PDKT-650-950B
Test cable assembly for PressureMAT accuracy check	PMAT-TCA
Pressure sensor cable dust cover /zero simulator for PressureMAT	PDKT-650-298CVR
DIN rail mounting kit for PMAT-S	PMAT-S-DIN
Installation qualification/operation qualification protocol documentation	PMAT-IQ/OQ
PMAT Panel mount kit – 2 gaskets, 4 mounting brackets, 2 sensor cables, and input connectors for sensors and power	PMAT-PANEL-2-C
PMAT Panel mount kit – 2 gaskets, 4 mounting brackets, 3 sensor cables, and input connectors for sensors and power	PMAT-PANEL-3-C
PMAT Panel mount kit – 2 gaskets, 4 mounting brackets, 4 sensor cables, and input connectors for sensors and power	PMAT-PANEL-4-C
PMAT Panel mount kit – 2 gaskets, 4 mounting brackets, 1 sensor cable, and input connectors for sensor and power	PMAT-PANEL-S-C
PMAT2 Panel mount kit UPGRADE – 2 gaskets, 4 mounting brackets, 2 sensor cables (in replacement of standard cable), and input connectors for sensors and power	PMAT-PANEL-2-U
PMAT3 Panel mount kit UPGRADE – 2 gaskets, 4 mounting brackets, 3 sensor cables (in replacement of standard cable), and input connectors for sensors and power	PMAT-PANEL-3-U
PMAT4 Panel mount kit UPGRADE – 2 gaskets, 4 mounting brackets, 4 sensor cables (in replacement of standard cable), and input connectors for sensors and power	PMAT-PANEL-4-U
PMAT-S Panel mount kit UPGRADE – 2 gaskets, 4 mounting brackets, sensor cable (in replacement of standard cable), input connectors for sensor and power	PMAT-PANEL-S-U
PressureMAT Power supply with circular barrel connector, 12VDC, 1 amp with plugs blades for destination	PMAT-PWR
Pinch Valve Pair – 24VDC supply & relay input for each normally closed valve – Small for 0.318 cm (1/8 in) ID	PDKT-PVE2-PMAT-S
Pinch Valve Pair – 24VDC supply & relay input for each normally closed valve – Medium for 0.64 cm (1/4 in) ID	PDKT-PVE2-PMAT-M
Pinch Valve- 24VDC supply & relay input for normally closed valve- Small for 0.318 cm (1/8 in) ID	PDKT-PVE-PMAT-S
Pinch Valve- 24VDC supply & relay input for normally closed valve- Medium for 0.64 cm (1/4 in) ID	PDKT-PVE-PMAT-M
<b>Pressure Sensor Transmitters 4-20 mA output</b>	
0.138 bar (0-2 psi) DIN Rail mount, 24VDC, with reusable sensor cable installed	PT-2
0.69 bar (10 psi) DIN Rail mount, 24VDC, with reusable sensor cable installed	PT-10
2.07 bar (30 psi) DIN Rail mount, 24VDC, with reusable sensor cable installed	PT-30
4.14 bar (60 psi) DIN Rail mount, 24VDC, with reusable sensor cable installed	PT-60
Cable Adapter for Single-Use Pressure Sensor 7 m (24 ft)	PDKT-650-298-24

# Single-Use Conductivity Sensor

## Simple, Accurate, Reliable



### Features Overview

- Pre-determined cell constant
- Optional one-point calibration
- Range: 0.1 to 100 mS/cm
- Accuracy:  $\pm 0.1$  mS/cm from 0.1 to 2 mS/cm
- Built-in temperature compensation
- Easy to use and maintain
- Affordable and cost-effective

### Efficient and Affordable Conductivity Measurement

Single-Use Conductivity Sensors provide precise and cost effective measurement of the conductivity of liquids in your biopharmaceutical processes.

### Ease of Maintenance

Our Single-Use Conductivity Sensors are sturdy enough to withstand repeated cleaning, yet affordable enough to be used in single-use applications. They offer a reliable alternative to stainless steel conductivity sensors, simplifying maintenance and reducing costs.

### Calibration-Free Conductivity

The Single-Use Conductivity Sensor is a reliable and accurate tool for measuring conductivity in a variety of applications. It is designed for single-use, which eliminates the need for calibration and maintenance. This makes it a cost-effective and convenient solution for biopharmaceutical manufacturing and chemical processing.

The sensor has a pre-determined cell constant, which means that it is ready to use immediately. It also has an optional one-point calibration feature, which allows users to calibrate the sensor for specific applications. The sensor has a range of 0.1 to 100 mS/cm and an accuracy of  $\pm 0.1$  mS/cm from 0.1 to 2 mS/cm. It also has built-in temperature compensation to ensure accurate readings over a wide range of temperatures.

The sensor is easy to install and use, even in harsh or corrosive environments. It is also durable and sterile, making it ideal for use in biopharmaceutical and other sterile applications. The sensor is also affordable, making it a cost-effective solution for a variety of applications.

### Measurement

No calibration required because of predetermined cell constant and also optional one-point calibration by user

### Compatibility and Resistance

Measure conductivity and temperature.

Fluid path materials

- Gamma & X-ray irradiation compatible
- NaOH resistant
- USP Class VI



Application	Description
Buffer Preparation	Monitor the conductivity to ensure that the final buffer solution meets specification.
Chromatography	Monitoring buffer conductivity prior to the chromatography column to protect the product by diverting out of specification product.
UF/DF	Monitor the diafiltration process to ensure buffer exchange endpoints are met.



### Did You Know

The CT-2 Conductivity Sensor Transmitter is a DIN rail mounted device that connects to a Single-Use Conductivity Sensor and produces a 4–20 milliamp signal that is linear with conductivity. It calculates the normalized value at 25 °C (77 °F) and transmits it via the 4–20 mA signal in the range of 0–150 mS.



### Sensor Specifications

Accuracy	From 0.1 to 2mS/cm $\pm$ 0.1 mS/cm; 2 to 50mS/cm $\pm$ 5% of reading; 50 to 100mS/cm typically $\pm$ 5% of reading
Pressure Range	75 psi max
Biocompatibility	All materials in contact with product fluid path meet USP Class VI requirements, both pre and post gamma exposure
Manufacturing Environment	ISO 9001 certified facility; Class 5
Operating Temperature	2 °C to 50 °C (35.6 °F to 122 °F) - other ranges with process qualification because thermistor reads to 70 °C (158 °F)
Temperature Accuracy	Better than 0.2 °C (0.36 °F) - typical better than 0.1 °C (0.18 °F)
Temperature Element	Thermistor with resistance @ 25 °C (77 °F) of 2252 ohm
Gamma Irradiation	Up to 50 kiloGrays
X-ray Irradiation	Up to 50 kiloGrays
ADCF Status	All fluid path materials are animal derived component free
Connector	Custom molded water-tight 4 pin connector Rating: IP67 when connected to reusable cable and dust cover
Shelf life	3 years
Packaging	Sealed in vapor barrier bag inside polybag

### Ordering Information

	Order Number
Single-Use Conductivity Sensor, non-sterile, polysulfone 0.318 cm (1/8 in) hose barb	CONDS-N-012
Single-Use Conductivity Sensor, non-sterile, polysulfone 0.64 cm (1/4 in) hose barb	CONDS-N-025
Single-Use Conductivity Sensor, non-sterile, polysulfone 1.28 cm (1/2 in) hose barb	CONDS-N-050
Conductivity Monitor test kit for conductance and temperature verification	CMONT-TKS
Individual Certificate of Analysis for Single-Use conductivity sensor (ea.)	CONDS2-COA
Conductivity Sensor Transmitter with 4–20mA output, 0–100mS operating range, 24 VDC, with quality certificate and 3.05 m (10 ft) sensor cable	CT-2

# Single-Use In-Line pH Sensor

pH Monitoring Made Easy

Single-Use pH Sensor

## Single-Use In-line pH Sensor Hassle-free pH measurement



1/4 inch Hose Barb



3/4 inch Sanitary Flange



### Features Overview

Single-use pH sensor combining METTLER TOLEDO InSUS 307 pH probe technology with single-use flow cell designed by Pendotech

- Designed for applications where in-line sensing is necessary
- Compatible with gamma irradiation
- No process calibration required
- Designed for use with existing METTLER TOLEDO transmitters

In downstream bioprocessing operations, monitoring and controlling the pH of a solution is critical to maintaining the stability and efficacy of large biomolecules. A pH sensor is a valuable tool used to determine the acidity or alkalinity of a solution. The electrochemical pH probe is a widely used method for measuring pH in these types of operations.

The Pendotech Single-Use In-line pH Sensor is a cutting-edge device that is designed for both Good Manufacturing Practice (GMP) operations and process development applications. This sensor comes pre-calibrated with values for slope offset and zero point constant, eliminating the need for process calibration. It is designed for applications where in-line sensing is necessary and is compatible with gamma irradiation. The sensor also has full traceability on materials and qualification of biocompatibility. It combines METTLER TOLEDO InSUS 307 pH probe technology with a single-use flow cell designed by Pendotech.

Available in two sizes as a pre-assembled product, it is an ideal choice for downstream processing applications where real-time, in-line measurements are necessary.

### Sensor Performance Specifications

pH Range	pH 3 to pH 10
Slope (pH 7 to pH 4 buffer)	Min -57.8 mV/pH (98%)
Zero-point (In pH 7 buffer)	7.20 ± 0.25pH
Accuracy under defined laboratory conditions	± 0.10 pH for ± 1.50 pH units around the calibration point after 1-point process calibration (adjustment of inline reading to an offline pH measurement of a grab sample)
Response Time	t90% < 20s between pH 4 to 7
Operating Temperature Range	5 to 60°C (41 to 140°F)
Operating Pressure Range	4 Barg at 25°C (77°F)* 2 Barg at 40°C (104°F)** 1 Barg at 60°C (140°F)**
Membrane Glass Resistance	300...900 MOhm
Glass Type	pH-Sensitive glass membrane
Temperature Compensation (T.C.)	Via built-in Pt 1000
Shelf life	12 months PT-PH-S-5-5, PT-PH-S-025 24 months with available coating on the reference system PT-PH-L-5-5, PT-PH-L-025

\* This specification was determined and validated by Pendotech. Testing and validation data regarding this claim are on file.

\*\*This specification is provided by the original manufacturer (PT-PH1 pH Sensor).

► [www.pendotech.com/ph](http://www.pendotech.com/ph)

### Benefits

- Provides accurate and reliable pH measurement in downstream bioprocessing operations
- Real-time measurement of pH helps to maintain stability of large biomolecules in a specific pH range
- Rapid response time helps to capture rapid shifts in pH due to process changes
- Calibration values printed on probe for easy entry into pH monitor, eliminating need for calibration with buffers
- Closed system operation is not impacted, as there is no need to expose pH sensor to buffer standards
- It may be re-used, however, in applications where cross contamination is to be avoided.



### The sensor/flow cell combination is designed specifically and optimized for in-line measurements:

- It is ideal for processes where cleaning the probe is not practical post use
- Has a rapid response to change in pH conditions

Application	Description
Upstream processing	Monitoring and control of pH in fermentation and cell culture processes, viral inactivation, and media/buffer preparation.
Downstream processing	Monitoring and control of pH in purification and product recovery processes, viral inactivation, buffer preparation, and protein refolding.
Quality control	Testing of the final product to ensure that it meets pH specifications.
Research and development	Development of new biopharmaceutical products and processes.

### Ordering Information

Monitors	Order Number
Dual pH Bench-Top monitor/transmitter for the interface of 2 Single-Use pH sensors.	MT-30280773
Cable from single wavelength photometer to TFF/DAQ, 2 m (6 ft)	PDKT-UV-PCS
Cable from single wavelength photometer to PMAT analog input, 2 m (6 ft)	PDKT-UV-PMAT
M8 3 pin male cordset, 2 m (6 ft), flying leads	1406281
M300 Transmitter Stand Kit ½ DIN	MT-58083319
Probes/Flow Cells	
Single-Use pH In-Line pH Sensor - 1.91 cm (¾ in) sanitary flange, polysulfone, 1-year Shelf-Life	PT-PH-S-5-5
Single-Use In-Line pH Sensor - 0.64 cm (¼ in) hose barb, polysulfone, 1-year Shelf-Life	PT-PH-S-025
Single-Use pH In-Line pH Sensor - 1.91 cm (¾ in) sanitary flange, polysulfone, 2-years Shelf-Life	PT-PH-L-5-5
Single-Use In-Line pH Sensor - 0.64 cm (¼ in) hose barb, polysulfone, 2-years Shelf-Life	PT-PH-L-025
Cables	
Cable VP6 ST/1m, for METTLER TOLEDO InSUS 307 Probe	MT-52300107
Cable VP6 ST/3m, for METTLER TOLEDO InSUS 307 Probe	MT-52300108
Cable VP6 ST/1m/BNC	MT-52300210
Cable VP6 ST/3m/BNC	MT-52300211

## PM2 Photometer and Single-Use UV/Turbidity

UV Absorbance Measurements, Simply and Quickly

### Single-Use UV Flow Cells & PM2 Photometer Ensuring Accuracy, One Measurement at a Time



The PM2 Photometer is a versatile tool for both lab and process applications, available in benchtop and panel mount versions for easy integration into various systems. It comes with seven factory-configurable wavelength combinations, including 260nm, 280nm, 300nm, 880nm, 260–280nm, 280–300nm, and 280–880nm.

Designed to work with a monitor possessing data acquisition capabilities, the PM2 Photometer can be used with Pendotech solutions like PressureMAT PLUS models for data logging via a PC, or Process Control Systems.

The photometer provides two 4–20mA signals spanning 0 to 3AU as output, allowing for continuous monitoring. It also features a local display for direct reading. The output signals can be connected to other data acquisition devices or higher-level control systems like PLCs and HMIs for data collection and integration into larger control systems.

The PM2 Photometer supports digital communication protocols such as Modbus over RS485 and Modbus-TCP over Ethernet for device monitoring, control, and network communication. This makes the PM2 Photometer a flexible solution for bioprocess monitoring due to its adaptability and compatibility with various systems.

EtherNet/IP



UK  
CA



#### Features Overview

- Dual functionality for lab and panel mount
- Versatile instrument for lab and process applications
- Factory configured with seven different wavelength combinations
- Designed to be integrated into a monitor with data acquisition capability
- Two 4–20mA output signals spanning 0 to 3AU
- Local display for viewing readings directly from the instrument
- Compatible with a variety of data acquisition devices and control systems
- Supports digital communication protocols

#### Photometer Specifications

Optical Configuration	LED light source
Optical Connectivity	SMA-905
Mechanical	10.2 cm (4 in) W × 10.2 cm (4 in) L × 6.4cm (2.5 in) H Weight: ~0.68kg (~1.5 lbs)
Max. supply voltage fluctuations	±10 % of DC supply voltage
Overvoltage Category	Category I
Power Requirement	24VDC nominal, 2.7W max power
Output	4-20mA (Active/sourcing) spanned 0-3AU
Analog Loop Resistance	500ohms at 24VDC
Alarm Relay	Max. 48VDC, Max. 1A
Operating Temperature	5 to 50 °C (41 to 122 °F)
Storage Temperature	–20 to 50 °C (–4 to 122 °F)
Operating Altitude	Max. 5000m above sea level
Humidity	20–80 % relative humidity, non-condensing
Measurement Range	0.000–3.00AU
Response Time	1 second
Maximum Zero Shift	±0.1 % full scale (±0.002AU)
Accuracy*	0-2AU ±1 %FS (±0.03AU) ; 2–3AU ±2 %FS (±0.06AU)
Long Term Output Drift	±0.1 % full scale (±0.002AU)
Precision/Repeatability	±0.5 % full scale (±0.015AU)
LED Lifetime	> 5 years
Emission Range	240–1000 nm
Regulatory	RoHS3, REACH, CE, UKCA

\* Accuracy is dependent on system arrangement and proper tare



Flow Cell Shown 1/2 inch hose barb with 1 cm path length



Flow Cell Installed with Tubing



Optical Couplers Installed to Flow Cell



6.5 cm Single-Use Turbidity Flow Cell

Pendotech's Single-Use Flow Cells allow non-invasive measurements using a unique silica glass lens. The fluid to be measured flows between the lenses via tubing attached to the flow cell ports. They come in various sizes and path lengths, with the largest recommended for turbidity applications. The 6.5 cm flow cell is ideal for turbidity measurements below 400 NTU, while the 1 cm flow cell is suitable for applications above 400 NTU. These low-cost flow cells are perfect for single-use applications but can be cleaned and reused. They meet USP Class VI standards and can be gamma and x-ray irradiated up to 50K Gy and autoclaved up to 121 °C (249°F).

### UV Absorbance

In bioprocess operations, UV absorbance is used to detect specific molecules, typically at 280 nm, using a spectrophotometer or photometer. The Single-Use UV Flow Cell and UV PM2 Photometer offer a non-invasive method for this. The flow cell, connected to the PM2 system with fiber optic cables, uses special silica glass lenses to pass light through the sample. The sample flows between the lenses via tubing attached to the flow cell. This low-cost flow cell is ideal for single-use applications but can also be cleaned and reused.

### Turbidity

Turbidity, the relative clarity of a liquid, is caused by suspended solids scattering light. It is measured by the difference in light emitted from a source and received by a detector, typically using near-infrared light at 880 nm. The standard unit is the Nephelometric Turbidity Unit (NTU). In bioprocess operations, turbidity post-filtration indicates filter performance on unclarified material from a bioreactor. The Turbidity System, which includes a photometer, flow cells, and cables, can measure turbidity online. The Single-Use Flow Cell eliminates the need for cleaning.

### Single-Use Flow Cell Specifications

Material	Polysulfone and fused silica with silicone O-ring
Pressure range	Rated for pressure up to 5 bar (75 psi)
Biocompatibility	All materials in contact with product fluid path meet USP Class VI requirements
Manufacturing Environment	ISO 7 clean room
Gamma Irradiation	Up to 50 kiloGrays
X-ray Irradiation	Up to 50 kiloGrays
Operating temperature	2 °C to 50 °C (35.6 °F to 122 °F) (other ranges with process qualification)
Storage temperature	-25 °C to 65 °C (-13 °F to 149 °F)
Shelf Life	>5 years

### Other Highlights

- Non-invasive measurement
- Real-time monitoring
- Cost-effective
- Durable
- Versatile
- Easy to use

## PM2 Photometer and Single-Use UV/Turbidity

UV Absorbance Measurements, Simply and Quickly

### Photometer / Transmitter Details

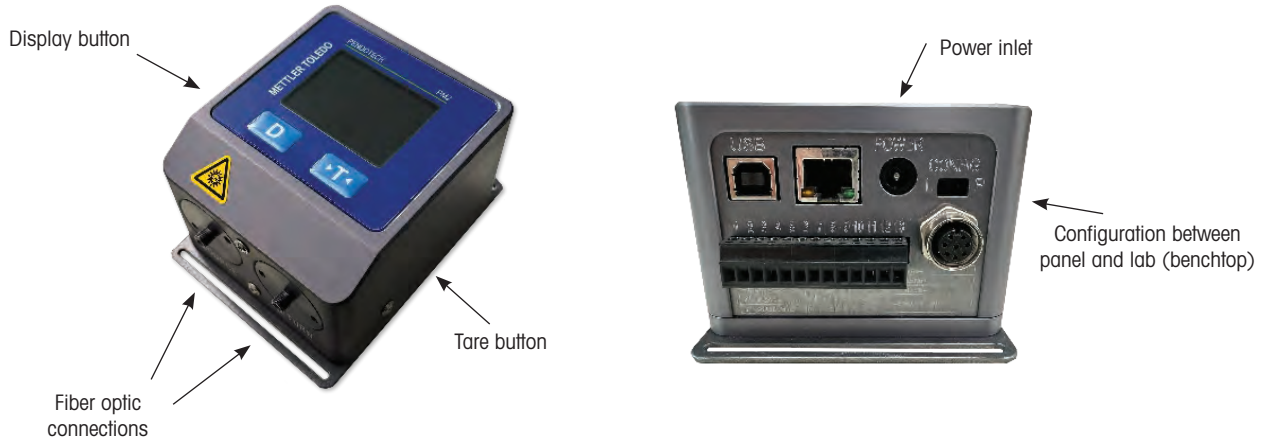

### Flow Cell Stands



Flow cell stand for 6.5 cm turbidity flow cell



Flow cell stand for single-use UV flow cell

### Did You Know

PM2 Test Rig Photometer Test Rig and Standards is designed for quick and easy accuracy verification of PM2 Photometers. The test kit includes one blank and 5 NIST-traceable filters, a test rig for holding the filters and for connecting the photometer, and a convenient holder.





## Ordering Information

Photometers	Order Number
Photometer PM2 260 nm	30 849 447
Photometer PM2 280 nm	30 849 498
Photometer PM2 300 nm	30 849 499
Photometer PM2 880 nm	30 849 500
Photometer PM2 260–280 nm	30 849 501
Photometer PM2 280–300 nm	30 849 502
Photometer PM2 280–880 nm	30 849 503

## Single-Use Flow Cells

Single-use UV flow cell, 2 mm (0.08 in) path length, non-sterile, polysulfone, 0.318 cm (1/8 in) hose barb	SPECPS-N-012
Single-Use UV Flow Cell, 0.5 cm (0.2 in) path length, non-sterile, polysulfone, 0.64 cm (¼ in) hose barb	SPECPS-N-025
Single-Use UV Flow Cell, 1 cm (0.4 in) path length, non-sterile, polysulfone, 1.28 cm (½ in) hose barb	SPECPS-N-050
Single-Use Flow Cell, 6.5 cm (2.5 in) path length, non-sterile, polysulfone, 1.90 cm (¾ in) Sanitary Flange Inlet/Outlet	SPECPS-880-6CM

## Couplers, Cables & Power Cords

Optical Coupler Single-Use Flow Cell	30 849 506
Optical Fiber Photometer 0.5 m (1.64 ft)	30 830 317
Optical Fiber Photometer 0.7 m (2.30 ft)	30 919 657
Optical Fiber Photometer 1 m (3.28 ft)	30 830 318
Optical Fiber Photometer 2 m (6.56 ft)	30 830 319
Optical Fiber Photometer 3 m (9.84 ft)	30 830 320
Panel mount SMA-905 connector (for pass through)	SPEC-OC-PANEL
Power Cord CN 3 Prong	30 305 179
Power Cord EU 3 Prong	30 305 178
Power Cord UK 3 Prong	30 305 174
Power Cord US 3 Prong	30 305 173
Mains Cable CH, 3P – For PM2 Photometer (Swiss Power Cord)	87920

## Accessories

Calibration Kit with Standards 3AU	30 849 507
Replacement Standards for Calibration Kit	30 849 508
SU Flow Cell Stand 6.5 cm (2.5 in) path length	30 849 504
SU Flow Cells Stand 1 cm (0.4 in) path length	30 849 505
Analog display with 4 inputs with alarm inputs and serial port for data collection	PMAT-DAQ
Analog display with 4 inputs, 4 analog outputs, alarms, and serial port for data collection	PMAT-DAQ-A
PM2 Photometer DIN Rail mounting kit, includes mounting plate and mounting hardware	PHOTO-DR
PM2 Photometer Panel Mount Support Bracket, with 2 × 1.28 cm (¼ in) - 20 × 1.28 cm (½ in) bolts	PHOTO-PNL

## Interface Cables

Cable from single channel PM2 photometer to PressureMAT analog input, 2 m (6 ft)	PDKT-PM2-1-PMAT
Cable from dual channel PM2 photometer to PressureMAT analog input, 2 m (6 ft)	PDKT-PM2-2-PMAT
Cable from single channel PM2 photometer to PCS Control System (DAQ/TFF), mA, 2 m (6 ft)	PDKT-PM2-1-PCS
Cable from dual channel PM2 photometer to Gen 2 TFF Control System, mA, 2 m (6 ft)	PDKT-PM2-2-PCS
Cable from single channel PM2 photometer to PDKT-BOX-NFFSS breakout box, M8 male, mA signal, 2 m (6 ft)	PDKT-PM2-1-NFFSSB
Cable from dual channel PM2 photometer to PDKT-BOX-NFFSS breakout box, 2 m (6 ft)	PDKT-PM2-2-NFFSSB
Cable from dual channel/turbidity photometer to flying leads, 2 m (6 ft)	PDKT-PM2-FL

# Single-Use Temperature Sensor

Simplicity Meets Accuracy

Single-Use Temperature Sensors

## Single-Use Temperature Sensors Accurate Temperature Measurement



Pendotech Single-Use Temperature Sensors measure temperature in your processes accurately and cost effectively. They are low cost for single-use applications where elimination of cross-contamination is required yet robust enough to be repeatedly cleaned and re-used. They are designed for in-line use and perfect for filtration and chromatography processes, filling operations, and general process monitoring. These sensors connect to monitors via a re-usable cable. Suitable monitors include the handheld unit TEMP-340, a Process Control System, or other pre-qualified third-party monitors. Also, a stand-alone transmitter is available with a 4 to 20mA analog output. They are the alternative solution for use with tubing to the existing temperature measurements devices on the market.

### Specifications

Accuracy	Hose-barb and flange sensors: Better than $\pm 0.2^\circ\text{C}$ ( $0.36^\circ\text{F}$ ) (typical better than $0.1^\circ\text{C}$ ( $0.18^\circ\text{F}$ )) Luer: Better than $\pm 0.4^\circ\text{C}$ ( $0.72^\circ\text{F}$ ) (typical better than $0.2^\circ\text{C}$ ( $0.36^\circ\text{F}$ ))
Temperature range	0 to $70^\circ\text{C}$ (0 to $158^\circ\text{F}$ )
Biocompatibility	Hose-barb and flange sensors: all polymeric materials in contact with product fluid path meet USP Class VI requirements
Manufacturing environment	ISO 9001 certified facility; Class 5
Gamma irradiation	Up to 50 kiloGrays <sup>^</sup>
X-ray irradiation	Up to 50 kiloGrays <sup>^</sup>
Resistance @ $25^\circ\text{C}$	2252ohm
Connector	Custom molded 2 contact connector (different versions for luer and hose-barb versions)
Pressure range	Up to 5.2 bar (75 psi)
Shelf life	5 years
Monitor Cable	Hose-barb: 3 m (10 ft) with 0.64 cm ( $\frac{1}{4}$ in) headphone plug to connect to monitor receptacle

### Features Overview

- Adaptable fittings
- No obstruction
- Luer fitting
- Temperature sensing element
- No calibration required

<sup>^</sup> At this gamma dose there is a shift in the accuracy in the range of 0 to  $2^\circ\text{C}$  to  $\pm 0.5^\circ\text{C}$  and in the range of 50 to  $70^\circ\text{C}$  to  $\pm 0.5^\circ\text{C}$ .

► [www.pendotech.com/temperature](http://www.pendotech.com/temperature)



## Sensor Features

To optimally adapt to tubing, the sensors are available with either a hose-barb fitting, a 1 inch sanitary flange, or a luer fitting. The hose-barb and flange sensor designs impart no obstruction on the fluid path that can cause a pressure drop. There is no dead-leg at the point where the temperature is measured. The luer fitting can be connected to a variety of fittings that can securely adapt to tubing or other devices. The temperature sensing element is a thermistor. No calibration is required because the temperature versus resistance for the thermistor element is well-defined within the specified accuracy range. Within the electrical instrument, the measured resistance is converted to the temperature. A disposable dip probe is also available to measure temperature within a vessel.

## Connection to Monitors

The hose-barb and flange sensors and dip probe connect to the monitor via a 3 m (10 ft) long re-usable cable. One end has a molded connector to connect to the sensor connector and the other end has a ¼ inch headphone plug commonly used by many commercially available monitors. The luer sensor has a custom molded connector on the 2.1 m (7 ft) long re-usable monitor cable that is quickly secured to the temperature sensor. There is an alignment guide on the sensor that prevents it from being connected improperly. Disconnection of the cable connector from the sensors is quick and easy and the monitor indicates the sensor has been disconnected.



TEMP-340 Handheld Monitor

## Ordering Information

Sensor	Order Number
Single-use temperature sensor, non-sterile, polysulfone, stainless steel sensor, 0.318 cm (1/8 in) hose barb	TEMPS-N-012
Single-use temperature sensor, non-sterile, polysulfone, stainless steel sensor, 0.64 cm (¼ in) hose barb	TEMPS-N-025
Single-use temperature sensor, non-sterile, polysulfone, stainless steel sensor, 0.95 cm (3/8 in) hose barb	TEMPS-N-038
Single-use temperature sensor, non-sterile, polysulfone, stainless steel sensor, 1.28 cm (½ in) hose barb	TEMPS-N-050
Single-use temperature sensor, non-sterile, polysulfone, stainless steel sensor, 1.90 cm (¾ in) hose barb	TEMPS-N-075
Single-use temperature sensor, non-sterile, polysulfone, 2.54 cm (1 in) sanitary flange	TEMPS-N-1-1
Single-use temperature sensor with luer fitting	TEMPC-N-999
Accessories for Sensors	
3 m (10 ft) re-usable temperature sensor cable with ¼ phone jack term. for hose barb sensors	PDKT-650-TEMPB
2.1 m (7 ft) re-usable temperature sensor cable with ¼ phone jack term. for luer sensors	PDKT-650-TEMPPL
30.48 cm (12 in) re-usable temperature sensor cable with M8 termination for hose barb sensors	PDKT-TEMPB-PNL
Temperature sensor monitor for 1 sensor with built-in data logger and RS-232 data output	TM-TEMP-340
Temperature Sensor Transmitter	TT1
Temperature Sensor Transmitter DIN Rail Mounting Kit	TT1-DR
Temperature Sensor Benchtop Transmitter with 4–20mA output in ABS plastic box with 24 VDC wall supply (for 1 sensor)	PDKT-TT1
Temperature Sensor Benchtop Transmitter with 4–20mA output in ABS plastic box with 24 VDC wall supply (for 2 sensors)	PDKT-TT2
Temperature Sensor Benchtop Transmitter with 4–20mA output in ABS plastic box with 24 VDC wall supply (for 4 sensors)	PDKT-TT4
Cable from PDKT-TT1 temperature transmitter to PressureMAT analog input, 2 m (6 ft)	PDKT-TT1-PMAT
Cable from PDKT-TT2 temperature transmitter to PressureMAT analog input (2×), 2 m (6 ft)	PDKT-TT2-PMAT
Analog display with 4 inputs with alarm inputs and serial port for data collection	PMAT-DAQ
Analog display with 4 inputs, 4 analog outputs, alarms, and serial port for data collection	PMAT-DAQ-A
Cable from PDKT-TT4 to PMAT-DAQ, 4 analog signals, 1.2 m (4 ft)	PDKT-TT4-PDAQ
0.64 x 0.64 cm (¼ in × ¼ in) polycarbonate straight connector with luer port	PDKT-103-03
0.95 x 0.95 cm (3/8 in × 3/8 in) polycarbonate straight connector with luer port	PDKT-104-03
1.27 x 1.27 cm (½ in × ½ in) polycarbonate straight connector with luer port	PDKT-105-03
Male x female x female luer tee, polycarbonate	PDKT-000-03
Male x female x female luer tee, polypropylene	PDKT-000-04

## Trademark Information

METTLER TOLEDO, the MT logo, Ingold, Thornton, Pendotech, ISM, ISM Core, InPro, InPro X1, InSUS, InDip, InTrac, InFlow, InFit, GPro, Pro2Go, UniCond, 7000RMS, pHure, pHure Sensor, PureO<sub>3</sub>, RecordLOC, Xerolyt, and PressureMAT are trademarks of the METTLER TOLEDO Group.

Viton and Kalrez are registered trademarks of DuPont Performance Elastomers LLC.

All other trademarks are the property of their respective holders.

For the most up-to-date addresses of  
METTLER TOLEDO globally, visit:  
**[www.mt.com/contacts](http://www.mt.com/contacts)**



# The Information You Want is at [www.mt.com/pro](http://www.mt.com/pro)

The METTLER TOLEDO Process Analytics website contains a vast amount of up-to-date information on all our products and services. Content is localized for your country and tailored to suit your selections. Simple layout allows you to quickly find the information and features you are looking for.



Visit our website for fast and competent information.

- Learn about our most recent product developments
- Register for free webinars
- Request further information on products and services
- Obtain a quote quickly and easily
- Download our latest white papers
- Read case studies relevant to your industry
- Access buffer and electrolyte solution certificates

[www.mt.com/pro](http://www.mt.com/pro)

Visit for more information

## **METTLER TOLEDO Group**

Process Analytics

Local contact: [www.mt.com/contacts](http://www.mt.com/contacts)

Subject to technical changes.

© 02/2024 METTLER TOLEDO. All rights reserved.

PA1000en – 52 900 315

Printed in Switzerland.